



STUDY REPORT

SR 225 (2010)

Residential Kitchen Local Fire Protection - Experiments

A.P. Robbins



The work reported here was jointly funded by BRANZ from the Building Research Levy and the New Zealand Fire Service Commission Contestable Research Fund.

© BRANZ 2010

ISSN: 1179-6197

Preface

This is the second of a series of two reports prepared during research into kitchen stove-top fires and a method of using cost effectiveness analyses to compare various solutions. The second report in this series is BRANZ Study Report 226, Residential Kitchen Local Fire Protection - Cost Effectiveness Analysis.

Acknowledgments

This work was jointly funded by BRANZ from the Building Research Levy and the New Zealand Fire Service Commission from the Contestable Research Fund.

Note

This report is intended for regulating authorities, policy advisers, researchers and fire engineers.

Any indication or reference to commercial entities, products, materials or systems in this document is only included here to assist in the description of the current state, concepts and experiments. No recommendations, endorsement or implication of adequacy of the entities, products, materials or systems identified in this document is made by BRANZ or the New Zealand Fire Service Commission.

Residential Kitchen Local Fire Protection – Experiments

BRANZ Study Report SR 225

A. P. Robbins

Reference

Robbins A.P. 2010. Residential Kitchen Local Fire Protection - Experiments. BRANZ SR 225. BRANZ. Judgeford, New Zealand.

Abstract

Residential kitchen fires are attributable to a large proportion of residential fire deaths, injuries and damage, therefore a reduction in kitchen related fires would make a significant impact in our community.

This report summarises an experiment-based approach developed to assess the performance of potential systems for use in suppression of local kitchen fires. A framework to quantify the effectiveness of such systems was also developed that includes a generic test method and a calculation methodology.

The influences of experimental parameters were investigated in the process of developing the test methodology.

A single sprinkler head is used to demonstrate the proposed test and effectiveness calculation methodologies for a limited fire challenge.

Contents	Page
1. INTRODUCTION.....	1
1.1 Motivation	1
1.2 Objectives	2
1.3 Scope	2
1.4 Approach.....	2
2. LITERATURE REVIEW	3
2.1 Current Standard Test Methods.....	3
3. DESCRIPTION OF EXPERIMENT APPARATUS.....	4
3.1 Test Procedure	7
3.2 Test Matrix	7
4. RESULTS.....	9
4.1 Skillet with No Oil, No Fan (Test 28).....	10
4.1.1 Analysis.....	11
4.2 Skillet with 200 ml Canola Oil, No Fan (Tests 30 & 31).....	13
4.2.1 Analysis.....	19
4.3 Skillet with 200 ml Canola Oil, Fan (Tests 7 – 9).....	21
4.3.1 Analysis.....	24
4.4 Skillet with 200 ml Peanut Oil, Fan (Tests 10 – 12).....	27
4.4.1 Analysis.....	33
4.5 Skillet with 400 ml Canola Oil, Fan (Tests 16 – 18).....	35
4.5.1 Analysis.....	41
4.6 Skillet with 200 ml Canola Oil, Fan, Corridor (Tests 55 & 59).....	43
4.6.1 Analysis.....	50
4.7 Skillet with 200 ml Canola Oil & Bacon, Fan (Test 22).....	52
4.7.1 Analysis.....	54
4.8 Skillet with 200 ml Canola Oil & 20 ml Water, Fan (Test 43).....	56
4.8.1 Analysis.....	58
4.9 Small Pan with 200 ml Canola Oil, Fan (Tests 13 – 15).....	60
4.9.1 Analysis.....	66
4.10 Stock Pot with 200 ml Canola Oil, Fan (Tests 19 – 21).....	68
4.10.1 Analysis.....	74
4.11 Skillet with 200 ml Canola Oil, Fan, 200 ml Water Added after Ignition (Tests 32 & 33).....	76
4.11.1 Analysis.....	82
4.12 Skillet with 200 ml Canola Oil, Fan, Heating Element De-energized After Ignition (Tests 35 & 37).....	84
4.12.1 Analysis.....	90
4.13 Skillet with 200 ml Canola Oil, Fan, Fire Blanket & De-energized After Ignition (Tests 38, 40 & 41).....	93
4.13.1 Analysis.....	99
4.14 Skillet with 200 ml Canola Oil, Fan, Dry Powder Extinguisher & De-energized After Ignition (Tests 45, 47 & 48).....	101

4.14.1 Analysis	107
4.15 Skillet with 200 ml Canola Oil, Fan, Single Automatic Sprinkler Head (Tests 57, 60)	109
4.15.1 Analysis	116
4.16 Skillet with 400 ml Canola Oil, Fan, Single Automatic Sprinkler Head (Test 70) ...	119
4.16.1 Analysis	122
4.17 Skillet with 200 ml Canola Oil, No Fan, Single Automatic Sprinkler Head (Tests 64 – 66)	124
4.17.1 Analysis	131
5. DISCUSSION OF RESULTS	133
5.1 Repeatability.....	133
5.2 Influence of Experimental Parameters.....	133
5.2.1 Electric or Gas Stove-top	133
5.2.2 Stove-top Hood and Compartment Air Movement.....	134
5.2.3 Cooking Vessel	136
5.2.4 Fuel.....	136
5.2.4.1 Fuel Additives.....	138
5.2.5 De-Energizing the Heating Element.....	139
5.2.6 Manual Fire Suppression.....	139
5.2.7 Application of Water on an Oil Fire.....	139
5.2.8 Single Sprinkler Head	140
6. ESTIMATING FIRE PROTECTION EFFECTIVENESS	142
6.1 Single Sprinkler Head Example	144
6.1.1 Comparing Fire Protected Test Results with the Base Challenge Scenario	144
6.1.2 Considering Maximum Measured Values.....	145
6.1.3 Estimating Effectiveness of a Local Fire Protection System.....	146
7. SUMMARY & CONCLUSIONS	151
7.1 Recommended Test Methodology.....	154
7.2 Recommendations for Future Research.....	155
8. REFERENCES.....	156
APPENDIX A METHOD OF ANALYSIS OF PLATE THERMOMETER DATA.....	158
A.1 General Description of Plate Thermometer Construction.....	158
A.2 Theory – Estimation of the incident radiation for a plate thermometer – Previous Approach.....	159
A.2.1 Impact of assumption - Uniform plate thermometer temperature.....	162
A.2.2 Impact of assumption - Convective heat transfer coefficient.....	163
A.2.3 Impact of assumption - Conduction correction factor	163
A.2.4 Impact of assumption - Local gas and backing insulation temperature	164
A.2.5 Impact of assumption - Lumped parameter model approach	164
A.2.6 Suggestions for alternative theories or estimate approaches	164
A.3 Theory – Estimation of the incident radiation for a plate thermometer – New Approach	166

A.3.1 Summary of assumptions.....	174
A.3.2 Summary of the Parameter Values Used in Analysis	175
A.3.3 Comparison of Results for the Two Analysis Approaches.....	175
APPENDIX B LIST OF KITCHEN FIRE TESTS	182
APPENDIX C SUMMARY OF TEST OBSERVATIONS	190
APPENDIX D DETAILS OF KITCHEN FIRE RESULTS.....	196
APPENDIX E ESTIMATING FIRE PROTECTION EFFECTIVENESS	197
E.1 Average Test Results for the Free-Burning Challenge Scenario	197
E.2 Normalised Average Test Results for the Free-Burning Challenge Scenario.....	206

Figures

Page

Figure 1: Schematic of the stove-top and surface thermocouple locations. Not to scale.4

Figure 2: Schematic of stove-top and plate thermometer and thermocouple tree above the heating element.....5

Figure 3: Schematic of the partial corridor orientation. Not to Scale.....6

Figure 4: Measured temperatures of the thermocouples and plate thermometers for a dry skillet containing no oil on an electric stove-top (Test 28). 10

Figure 5: Estimates of the incident radiation for the plate thermometers located 50 mm and 350 mm above the surface of the stove-top for a dry skillet containing no oil on an electric stove-top (Test 28). 11

Figure 6: Differences of each of the variable temperatures to between sequential time steps for a dry skillet containing no oil on an electric stove-top (Test 28). 11

Figure 7: Ratios of each of the variable temperatures to the temperatures at the time of ignition for a dry skillet containing no oil on an electric stove-top (Test 28). 12

Figure 8: Thermocouple measurements for the thermocouple located (a) in the oil in the skillet, (b) 100 mm above the centre of the skillet, and (c) 400 mm above the centre of the skillet for Tests 30 and 31..... 14

Figure 9: Plate thermometer temperature measurements for (a) at the height of the lip of the skillet, and (b) 300 mm above the lip of the skillet for Tests 30 and 31. 15

Figure 10: Thermocouple measurements of (a) thermocouple A, (b) thermocouple B, (c) thermocouple C, (d) thermocouple D, and (e) thermocouple E for Tests 30 and 31..... 18

Figure 11: Estimates of the incident radiation on the plate thermometer (a) at the height of the lip of the skillet, and (b) 300 mm above the lip of the skillet for Tests 30 and 31. 19

Figure 12: Examples of the differences of each of the variable temperatures to between sequential time steps for Test 30.20

Figure 13: Examples of the ratios of each of the variable temperatures to the temperatures at the time of ignition for Test 30.20

Figure 14: Thermocouple measurements for the thermocouple located (a) in the oil in the skillet, (b) 100 mm above the centre of the skillet, and (c) 400 mm above the centre of the skillet for Tests 7 – 9. 22

Figure 15: Plate thermometer temperature measurements for (a) at the height of the lip of the skillet, and (b) 300 mm above the lip of the skillet.....23

Figure 16: Heat release rates estimated from oxygen calorimetry for Tests 7 – 9.....24

Figure 17: Estimates of the incident radiation on the plate thermometer (a) at the height of the lip of the skillet, and (b) 300 mm above the lip of the skillet.25

Figure 18: Examples of the differences of each of the variable temperatures to between sequential time steps for Test 8.25

Figure 19: Examples of the ratios of each of the variable temperatures to the temperatures at the time of ignition for Test 8.26

Figure 20: Thermocouple measurements for the thermocouple located (a) in the oil in the skillet, (b) 100 mm above the centre of the skillet, and (c) 400 mm above the centre of the skillet for Tests 10 – 12.....28

Figure 21: Plate thermometer temperature measurements for (a) at the height of the lip of the skillet, and (b) 300 mm above the lip of the skillet for Tests 10 – 12.29

Figure 22: Thermocouple measurements of (a) thermocouple A, (b) thermocouple B, (c) thermocouple C, (d) thermocouple D, and (e) thermocouple E for Tests 11 and 12.....32

Figure 23: Heat release rates estimated from oxygen calorimetry for Tests 11 and 12.32

Figure 24: Estimates of the incident radiation on the plate thermometer (a) at the height of the lip of the skillet, and (b) 300 mm above the lip of the skillet.33

Figure 25: Examples of the differences of each of the variable temperatures to between sequential time steps for Test 11.....34

Figure 26: Examples of the ratios of each of the variable temperatures to the temperatures at the time of ignition for Test 11.34

Figure 27: Thermocouple measurements for the thermocouple located (a) in the oil in the skillet, (b) 100 mm above the centre of the skillet, and (c) 400 mm above the centre of the skillet for Tests 16 – 18.....	36
Figure 28: Plate thermometer temperature measurements for (a) at the height of the lip of the skillet, and (b) 300 mm above the lip of the skillet for Tests 16 – 18.	37
Figure 29: Thermocouple measurements of (a) thermocouple A, (b) thermocouple B, (c) thermocouple C, (d) thermocouple D, and (e) thermocouple E for Tests 16 – 18.....	40
Figure 30: Heat release rates estimated from oxygen calorimetry for Tests 16 – 18.....	40
Figure 31: Estimates of the incident radiation on the plate thermometer (a) at the height of the lip of the skillet, and (b) 300 mm above the lip of the skillet for Tests 16 – 18.	41
Figure 32: Examples of differences of each of the variable temperatures to between sequential time steps for Test 17.....	42
Figure 33: Examples of ratios of each of the variable temperatures to the temperatures at the time of ignition for Test 17.	42
Figure 34: Thermocouple measurements for the thermocouple located (a) in the oil in the skillet, (b) 100 mm above the centre of the skillet, and (c) 400 mm above the centre of the skillet for Tests 55 and 59.....	44
Figure 35: Plate thermometer temperature measurements for (a) at the height of the lip of the skillet, and (b) 300 mm above the lip of the skillet for Tests 55 and 59.	45
Figure 36: Thermocouple measurements of (a) thermocouple A, (b) thermocouple B, (c) thermocouple C, (d) thermocouple D, and (e) thermocouple E for Tests 55 and 59.....	48
Figure 37: Thermocouple measurements at the ceiling (a) 770 mm from the wall and centred in the corridor, and (b) directly above the centre of the skillet for Tests 55 and 59.....	49
Figure 38: Heat release rates estimated from oxygen calorimetry for Tests 55 and 59.	49
Figure 39: Estimates of the incident radiation on the plate thermometer (a) at the height of the lip of the skillet, and (b) 300 mm above the lip of the skillet for Tests 55 and 59.	50
Figure 40: Examples of differences of each of the variable temperatures to between sequential time steps for Test 55.....	51
Figure 41: Examples of ratios of each of the variable temperatures to the temperatures at the time of ignition for Test 55.	51
Figure 42: Measured temperatures of the thermocouples and plate thermometers for a dry skillet containing 200 ml canola oil and 2 rashers of bacon on an electric stove-top with the furniture calorimeter fan running (Test 22).....	52
Figure 43: Measured temperatures of the thermocouples along the vertical line from the centre of the heating element for a dry skillet containing 200 ml canola oil and 2 rashers of bacon on an electric stove-top with the furniture calorimeter fan running (Test 22).....	53
Figure 44: Measured temperatures of the thermocouples on the surface of the stove-top (A-E) and the plate thermometers for a dry skillet containing 200 ml canola oil and 2 rashers of bacon on an electric stove-top with the furniture calorimeter fan running (Test 22).....	53
Figure 45: Estimates of the incident radiation for the plate thermometers located 50 mm and 350 mm above the surface of the stove-top for a dry skillet containing 200 ml canola oil and 2 rashers of bacon on an electric stove-top with the furniture calorimeter fan running (Test 22).	54
Figure 46: Differences of each of the variable temperatures to between sequential time steps for a dry skillet containing 200 ml canola oil and 2 rashers of bacon on an electric stove-top with the furniture calorimeter fan running (Test 22).....	54
Figure 47: Ratios of each of the variable temperatures to the temperatures at the time of ignition for a dry skillet containing 200 ml canola oil and 2 rashers of bacon on an electric stove-top with the furniture calorimeter fan running (Test 22).	55
Figure 48: Measured temperatures of the thermocouples and plate thermometers for a skillet containing 200 ml canola oil and 20 ml water on an electric stove-top with the furniture calorimeter fan running (Test 43).....	56
Figure 49: Measured temperatures of the thermocouples in a vertical line above the centre of the heating element for a skillet containing 200 ml canola oil and 20 ml water on an electric stove-top with the furniture calorimeter fan running (Test 43).	57

Figure 50: Measured temperatures of the thermocouples on the surface of the stove-top (A-E) and plate thermometers for a skillet containing 200 ml canola oil and 20 ml water on an electric stove-top with the furniture calorimeter fan running (Test 43).	57
Figure 51: Estimates of the incident radiation for the plate thermometers located 50 mm and 350 mm above the surface of the stove-top for a skillet containing 200 ml canola oil and 20 ml water on an electric stove-top with the furniture calorimeter fan running (Test 43).	58
Figure 52: Differences of each of the variable temperatures to between sequential time steps for a skillet containing 200 ml canola oil and 20 ml water on an electric stove-top with the furniture calorimeter fan running (Test 43).	58
Figure 53: Ratios of each of the variable temperatures to the temperatures at the time of ignition for a skillet containing 200 ml canola oil and 20 ml water on an electric stove-top with the furniture calorimeter fan running (Test 43).	59
Figure 54: Thermocouple measurements for the thermocouple located (a) in the oil in the small pan, (b) 100 mm above the centre of the skillet, and (c) 400 mm above the centre of the small pan for Tests 13 – 15.	61
Figure 55: Plate thermometer temperature measurements for (a) 50 mm above the surface of the stove-top, and (b) 350 mm above the surface of the stove-top for Tests 13 – 15.	62
Figure 56: Thermocouple measurements of (a) thermocouple A, (b) thermocouple B, (c) thermocouple C, (d) thermocouple D, and (e) thermocouple E for Tests 13 – 15.	65
Figure 57: Heat release rates estimated from oxygen calorimetry for Tests 13 – 15.	65
Figure 58: Estimates of the incident radiation on the plate thermometer (a) 50 mm and (b) 350 mm above the surface of the stove-top for Tests 13 – 15.	66
Figure 59: An example of the differences of each of the variable temperatures to between sequential time steps for Test 14.	67
Figure 60: An example of the ratios of each of the variable temperatures to the temperatures at the time of ignition for Test 14.	67
Figure 61: Thermocouple measurements for the thermocouple located (a) in the oil in the stock pot, (b) 100 mm above the centre of the skillet, and (c) 400 mm above the centre of the stock pot for Tests 19 – 21.	69
Figure 62: Plate thermometer temperature measurements for (a) 50 mm above the surface of the stove-top, and (b) 350 mm above the surface of the stove-top for Tests 19 – 21.	70
Figure 63: Thermocouple measurements of (a) thermocouple A, (b) thermocouple B, (c) thermocouple C, (d) thermocouple D, and (e) thermocouple E for Tests 19 – 21.	73
Figure 64: Heat release rates estimated from oxygen calorimetry for Tests 19 – 21.	73
Figure 65: Estimates of the incident radiation on the plate thermometer (a) 50 mm and (b) 350 mm above the surface of the stove-top for Tests 19 – 21.	74
Figure 66: Examples of differences of each of the variable temperatures to between sequential time steps for Test 19.	75
Figure 67: Examples of ratios of each of the variable temperatures to the temperatures at the time of ignition for Test 19.	75
Figure 68: Thermocouple measurements for the thermocouple located (a) in the oil in the skillet, (b) 100 mm above the centre of the skillet, and (c) 400 mm above the centre of the skillet for Tests 32 and 33.	77
Figure 69: Plate thermometer temperature measurements for (a) at the height of the lip of the skillet, and (b) 300 mm above the lip of the skillet for Tests 32 and 33.	78
Figure 70: Thermocouple measurements of (a) thermocouple A, (b) thermocouple B, (c) thermocouple C, (d) thermocouple D, and (e) thermocouple E for Tests 32 and 33.	81
Figure 71: Heat release rates estimated from oxygen calorimetry for Tests 32 and 33.	81
Figure 72: Estimates of the incident radiation on the plate thermometer (a) at the height of the lip of the skillet, and (b) 300 mm above the lip of the skillet.	82
Figure 73: Examples of the differences of each of the variable temperatures to between sequential time steps for Test 33.	83
Figure 74: Examples of the ratios of each of the variable temperatures to the temperatures at the time of ignition for Test 33.	83

Figure 75: Thermocouple measurements for the thermocouple located on the electric element for Tests 35 and 37.....	84
Figure 76: Thermocouple measurements for the thermocouple located (a) in the oil in the skillet, (b) 100 mm above the centre of the skillet, and (c) 400 mm above the centre of the skillet for Tests 35 and 37.....	86
Figure 77: Plate thermometer temperature measurements for (a) at the height of the lip of the skillet, and (b) 300 mm above the lip of the skillet for Tests 35 and 37.	87
Figure 78: Thermocouple measurements of (a) thermocouple A, (b) thermocouple B, (c) thermocouple C, (d) thermocouple D, and (e) thermocouple E for Tests 35 and 37.....	89
Figure 79: Heat release rates estimated from oxygen calorimetry for Tests 35 and 37.	90
Figure 80: Estimates of the incident radiation on the plate thermometer (a) at the height of the lip of the skillet, and (b) 300 mm above the lip of the skillet for Tests 35 and 37.	91
Figure 81: An example of differences of each of the variable temperatures to between sequential time steps for Test 37.....	91
Figure 82: An example of ratios of each of the variable temperatures to the temperatures at the time of ignition for Test 37.	92
Figure 83: Thermocouple measurements for the thermocouple located (a) in the oil in the stock pot, (b) 100 mm above the centre of the skillet, and (c) 400 mm above the centre of the stock pot for Tests 38, 40 and 41.	94
Figure 84: Plate thermometer temperature measurements for (a) 50 mm above the surface of the stove-top, and (b) 350 mm above the surface of the stove-top for Tests 38, 40 and 41.	95
Figure 85: Thermocouple measurements of (a) thermocouple A, (b) thermocouple B, (c) thermocouple C, (d) thermocouple D, and (e) thermocouple E for Tests 38, 40 and 41.....	98
Figure 86: Heat release rates estimated from oxygen calorimetry for Tests 38, 40 and 41.	98
Figure 87: Estimates of the incident radiation on the plate thermometer (a) 50 mm and (b) 350 mm above the surface of the stove-top for Tests 38, 40 and 41.....	99
Figure 88: An example of differences of each of the variable temperatures to between sequential time steps for Test 38.....	100
Figure 89: An example of ratios of each of the variable temperatures to the temperatures at the time of ignition for Test 38.	100
Figure 90: Thermocouple measurements for the thermocouple located (a) in the oil in the stock pot, (b) 100 mm above the centre of the skillet, and (c) 400 mm above the centre of the stock pot for Tests 45, 47 and 48.	102
Figure 91: Plate thermometer temperature measurements for (a) 50 mm above the surface of the stove-top, and (b) 350 mm above the surface of the stove-top for Tests 45, 47 and 48.....	103
Figure 92: Thermocouple measurements of (a) thermocouple A, (b) thermocouple B, (c) thermocouple C, (d) thermocouple D, and (e) thermocouple E for Tests 45, 47 and 48.....	106
Figure 93: Heat release rates estimated from oxygen calorimetry for Test 48.	106
Figure 94: Estimates of the incident radiation on the plate thermometer (a) 50 mm and (b) 350 mm above the surface of the stove-top for Tests 45, 47 and 48.....	107
Figure 95: An example of differences of each of the variable temperatures to between sequential time steps for Test 47.....	108
Figure 96: An example of ratios of each of the variable temperatures to the temperatures at the time of ignition for Test 47.	108
Figure 97: Thermocouple measurements for the thermocouple located (a) in the oil in the skillet, (b) 100 mm above the centre of the skillet, and (c) 400 mm above the centre of the skillet for Tests 56 and 60.....	110
Figure 98: Plate thermometer temperature measurements for (a) at the height of the lip of the skillet, and (b) 300 mm above the lip of the skillet for Tests 56 and 60.	111
Figure 99: Thermocouple measurements of (a) thermocouple A, (b) thermocouple B, (c) thermocouple C, (d) thermocouple D, and (e) thermocouple E for Tests 56 and 60.....	114
Figure 100: Thermocouple measurements at the ceiling (a) 1500 mm from the wall and centred in the corridor (at the sprinkler head), (b) 770 mm from the wall and centred in the corridor, and (b) directly above the centre of the skillet for Tests 56 and 60.	115
Figure 101: Heat release rates estimated from oxygen calorimetry for Tests 56 and 60.	116

Figure 102: Estimates of the incident radiation on the plate thermometer (a) at the height of the lip of the skillet, and (b) 300 mm above the lip of the skillet for Tests 56 and 60.	117
Figure 103: An example of differences of each of the variable temperatures to between sequential time steps for Test 57.	117
Figure 104: An example of ratios of each of the variable temperatures to the temperatures at the time of ignition for Test 57.	118
Figure 105: Measured temperatures of the thermocouples and plate thermometers for a skillet containing 400 ml canola oil on an electric stove-top against a wall in a partial corridor with the furniture calorimeter fan running and protected by a single sprinkler head (Test 70).	119
Figure 106: Measured temperatures of the thermocouples in a vertical line above the centre of the heating element for a skillet containing 400 ml canola oil on an electric stove-top against a wall in a partial corridor with the furniture calorimeter fan running and protected by a single sprinkler head (Test 70).	120
Figure 107: Measured temperatures of the thermocouples on the stove-top surface (A-E) and plate thermometers for a skillet containing 400 ml canola oil on an electric stove-top against a wall in a partial corridor with the furniture calorimeter fan running and protected by a single sprinkler head (Test 70).	120
Figure 108: Measured temperatures of the thermocouples at the ceiling of the partial corridor for a skillet containing 400 ml canola oil on an electric stove-top against a wall in a partial corridor with the furniture calorimeter fan running and protected by a single sprinkler head (Test 70).	121
Figure 109: Estimates of the incident radiation for the plate thermometers located 50 mm and 350 mm above the surface of the stove-top for a skillet containing 400 ml canola oil on an electric stove-top against a wall in a partial corridor with the furniture calorimeter fan running and protected by a single sprinkler head (Test 70).	122
Figure 110: Differences of each of the variable temperatures to between sequential time steps for a skillet containing 400 ml canola oil on an electric stove-top against a wall in a partial corridor with the furniture calorimeter fan running and protected by a single sprinkler head (Test 70).	122
Figure 111: Ratios of each of the variable temperatures to the temperatures at the time of ignition for a skillet containing 400 ml canola oil on an electric stove-top against a wall in a partial corridor with the furniture calorimeter fan running and protected by a single sprinkler head (Test 70).	123
Figure 112: Thermocouple measurements for the thermocouple located (a) in the oil in the skillet, (b) 100 mm above the centre of the skillet, and (c) 400 mm above the centre of the skillet for Tests 64 – 66.	125
Figure 113: Plate thermometer temperature measurements for (a) at the height of the lip of the skillet, and (b) 300 mm above the lip of the skillet for Tests 64 – 66.	126
Figure 114: Thermocouple measurements of (a) thermocouple A, (b) thermocouple B, (c) thermocouple C, (d) thermocouple D, and (e) thermocouple E for Tests 56 and 60.	129
Figure 115: Thermocouple measurements at the ceiling (a) 1500 mm from the wall and centred in the corridor (at the sprinkler head), (b) 770 mm from the wall and centred in the corridor, and (b) directly above the centre of the skillet for Tests 64 – 66.	130
Figure 116: Estimates of the incident radiation on the plate thermometer (a) at the height of the lip of the skillet, and (b) 300 mm above the lip of the skillet for Tests 64 – 66.	131
Figure 117: Differences of each of the variable temperatures to between sequential time steps for Test 64.	132
Figure 118: Ratios of each of the variable temperatures to the temperatures at the time of ignition for Test 64.	132
Figure 119: Schematic of the back and side of a plate thermocouple. Extracted from (<i>ISO 834-1 1999</i>) and (<i>EN 1363-1 1999</i>).	159
Figure 120: Schematic of heat transfer concerning a plate thermometer. Not to scale.	160
Figure 121: Schematic of heat transfer concerning a plate thermometer, based on the new approach to the analysis. Not to scale.	167

Figure 122: Temperature dependent specific heat values for INCONEL® 600. Adapted from <i>INCONEL® 600</i> (2008).....	170
Figure 123: Temperature dependent thermal conductivity values for INCONEL® 600. Adapted from <i>INCONEL® 600</i> (2008).	170
Figure 124: Temperature dependent density values for dry air. Adapted from Holman (1990).171	
Figure 125: Temperature dependent specific heat values for dry air. Adapted from Holman (1990).....	171
Figure 126: Temperature dependent kinematic viscosity values for dry air. Adapted from Holman (1990).	172
Figure 127: Temperature dependent Prandtl number values for dry air. Adapted from Holman (1990).....	172
Figure 128: Comparison of the two analysis approaches for a bolted plate thermometer subjected to a target incident radiation of 9 kW/m ² .K.....	176
Figure 129: Comparison of the two analysis approaches for three bolted plate thermometers subjected to a target incident radiation of 9 kW/m ² .K.....	176
Figure 130: Comparison of analysis approach B for three bolted plate thermometers subjected to a target incident radiation of 9 kW/m ² .K and results from analysis approach A for a spot welded plate thermometer subjected to a target incident radiation of 9.4 kW/m ² .K...177	
Figure 131: Comparison of the two analysis approaches for three bolted plate thermometers subjected to a target incident radiation of 9 kW/m ² .K and results from analysis approach A for a spot welded plate thermometer subjected to a target incident radiation of 9.4 kW/m ² .K...177	
Figure 132: Comparison of the two analysis approaches for a bolted plate thermometer subjected to a target incident radiation of 14.8 kW/m ² .K.	178
Figure 133: Comparison of the two analysis approaches for three bolted plate thermometers subjected to a target incident radiation of 14.8 kW/m ² .K.	178
Figure 134: Comparison of analysis approach B for three bolted plate thermometers subjected to a target incident radiation of 14.8 kW/m ² .K and results from analysis approach A for a spot welded plate thermometer subjected to a target incident radiation of 14.4 kW/m ² .K.179	
Figure 135: Comparison of the two analysis approaches for three bolted plate thermometers subjected to a target incident radiation of 14.8 kW/m ² .K and results from analysis approach A for a spot welded plate thermometer subjected to a target incident radiation of 14.4 kW/m ² .K.179	
Figure 136: Comparison of the two analysis approaches for a bolted plate thermometer subjected to a target incident radiation of 19.0 kW/m ² .K.	180
Figure 137: Comparison of the two analysis approaches for three bolted plate thermometers subjected to a target incident radiation of 19.0 kW/m ² .K.	180
Figure 138: Comparison of analysis approach B for three bolted plate thermometers subjected to a target incident radiation of 19.0 kW/m ² .K and results from analysis approach A for a spot welded plate thermometer subjected to a target incident radiation of 19.4 kW/m ² .K.181	
Figure 139: Comparison of the two analysis approaches for three bolted plate thermometers subjected to a target incident radiation of 19.0 kW/m ² .K and results from analysis approach A for a spot welded plate thermometer subjected to a target incident radiation of 19.4 kW/m ² .K.181	
Figure 368: Thermocouple measurements for the thermocouple located on the heating element under the skillet for Tests 55 and 59 and the average of these tests.	197
Figure 369: Thermocouple measurements for the thermocouple located (a) in the oil in the skillet, (b) 100 mm above the centre of the skillet, and (c) 400 mm above the centre of the skillet for Tests 55 and 59 and the average of these tests.	198
Figure 370: Plate thermometer temperature measurements for (a) at the height of the lip of the skillet, and (b) 300 mm above the lip of the skillet for Tests 55 and 59 and the average of these tests.....	199
Figure 371: Thermocouple measurements of (a) thermocouple A, (b) thermocouple B, (c) thermocouple C, (d) thermocouple D, and (e) thermocouple E for Tests 55 and 59 and the average of these tests.	202
Figure 372: Thermocouple measurements at the ceiling (a) over the centre of the heating element, (b) 770 mm from the wall and centred in the corridor, and (c) directly above the centre of the skillet for Tests 55 and 59 and the average of these tests.....	203

Figure 373: Heat release rates estimated from oxygen calorimetry for Tests 55 and 59 and the average of these tests.	204
Figure 374: Estimates of the incident radiation on the plate thermometer (a) at the height of the lip of the skillet, and (b) 300 mm above the lip of the skillet for Tests 55 and 59 and the average of these tests.	205
Figure 375: Normalised average thermocouple measurements for the thermocouple located (a) in the oil in the skillet, (b) 100 mm above the centre of the skillet, and (c) 400 mm above the centre of the skillet for Tests 55 and 59.	207
Figure 376: Normalised average plate thermometer temperature measurements for (a) at the height of the lip of the skillet, and (b) 300 mm above the lip of the skillet for Tests 55 and 59.	208
Figure 377: Normalised average thermocouple measurements of (a) thermocouple A, (b) thermocouple B, (c) thermocouple C, (d) thermocouple D, and (e) thermocouple E for Tests 55 and 59.	210
Figure 378: Normalised average thermocouple measurements at the ceiling (a) over the centre of the heating element, (b) 770 mm from the wall and centred in the corridor, and (c) directly above the centre of the skillet for Tests 55 and 59.	212

Tables

Page

Table 1: List of summarised kitchen stove-top fire tests.....	9
Table 2: Summary of maximum measured values for the free-burning challenge scenario and the equivalent scenario with fire protection.	147
Table 3: Summary of summations of normalised values for the free-burning challenge scenario and the equivalent scenario with fire protection from 5 s prior to ignition to flameout.	148
Table 4: Summary of improvement in measured experimental conditions for the scenario with fire protection compared to the free-burning challenge scenario based on summations of normalised values.	149
Table 5: Summary of improvement in maximum values of measured experimental conditions for the scenario with fire protection compared to the free-burning challenge scenario based on the values summarised in Table 2.	150
Table 6: Summary of the temperature material properties of INCONEL® 600 and dry air. .	173
Table 7: Summary of constant parameter values used in calculations.	175
Table 8: Summary of kitchen stove-top fire tests	182
Table 9: Summary of observations during kitchen stove-top fire tests	190

1. INTRODUCTION

Residential kitchen fires are attributable to a large proportion of residential fire deaths, injuries and damage, therefore a reduction in kitchen related fires would make a significant impact in our community. A rigorous, science-based method is needed to assess the performance of potential systems for use in suppression of local kitchen fires. A framework to quantify the impact of such systems is also needed.

Development of a generic test method and quantitative performance criteria for determining the appropriateness of retrofit active residential kitchen local stove-top fire protection systems was conducted to provide a basis for future guidelines for appropriate design and assessment for local residential kitchen fire protection systems. This experience and data was incorporated into the cost effectiveness assessment methodology, developed to provide a way to compare different types of systems that could be used for control or suppression of stove-top fires (Robbins 2010).

1.1 Motivation

Use of home sprinkler systems is rapidly gaining traction in New Zealand and is generally most suitable for inclusion in new houses rather than retrofit applications since these systems are more expensive to retrofit. Targeting the existing housing stock throughout New Zealand with quick-win fire protection strategies will be more likely to impact positively on reducing the fire incident rate in houses in the short to medium term. Home sprinkler systems, while offering a more complete protection strategy, can be seen as a medium to long term solution. A local fire protection system, targeting the stove-top, could be present in conjunction with a home sprinkler or residential sprinkler system to provide added targeted protection.

Over the period 1995-2005 in New Zealand, kitchen fires accounted for approximately 14,000 incidents, 60 deaths and 1200 injuries. As a percentage of the total for all fires in residential buildings this represents 41% of the total incidents, 25% of the total deaths and 44% of the total injuries (Robbins, Wade et al. 2008). These statistics are based on incidents reported to the New Zealand Fire Service, however there may be many more fires extinguished by occupants and not reported. Adopting a strategy that focuses on reducing the number of serious kitchen fires has the potential to lead to fewer fire deaths and injuries as well as the associated reductions in the amount of fire-damaged property.

There are many ways of approaching the reduction of cooking fire problems, including

- Community education,
- Improved detection,
- Thermostatic safety controls on cooking equipment and
- Suppression systems.

The research summarised here focuses on potential suppression systems.

The potential use of inexpensive localized fire protection systems in high fire risk areas (e.g. kitchens) for retrofit applications is a strategy currently being pursued by the United States Fire Administration (USFA) through their National Residential Fire Sprinkler Initiative (USFA 2007). Since 14% of all fatal residential fires in the US (1989-1998) are initiated in the kitchen, it is thought that having automatic suppression capability in the kitchens of manufactured homes would have the potential to provide a significant impact on reducing the number of deaths and injuries in those buildings. Contributing to this effort, the US National Institute of Standards and Technology

(NIST) are currently developing a test method to examine the performance of automatic fire suppression and control systems for kitchen stove-top residential applications (Madrzykowski, Hamins and Mehta 2007). Their study is also aligned with the USFA National Residential Fire Sprinkler Initiative (USFA 2007).

There are many different approaches and therefore potential outcomes (in terms of the interrelated aspects of coverage, effectiveness and reliability, for example) for localised fire protection specifically for residential kitchen stove-top (or range) fires. A test method and performance criteria that can be used to assess different potential systems is needed to assess the appropriateness of a diverse stove-top of systems. This research is the initial development of a framework for a cost effectiveness module that includes results from a laboratory assessment of a specific design. This framework was developed to allow a more holistic comparison of potential different designs.

1.2 Objectives

The objectives for the experimental section of this research were

- to develop a generic test method and quantitative performance criteria for determining the appropriateness of retrofit active residential kitchen local stove-top fire protection systems, and
- to contribute experimental data and test method experience to the other part of the project focused on using a cost effectiveness analysis approach to evaluate the NZ situation.

1.3 Scope

This project focuses on reducing the problem of cooking fires using the approach of local suppression systems. Specifically, the experimental aspect of this project was to investigate and develop a test method that could be used to assess the effectiveness of fire protection systems for kitchen stove-top fires.

The fuel is limited to canola and peanut oil. The area of a kitchen considered is limited to the stove top; the influence of additional furniture or other kitchen contents was outside the scope of the research project summarised here.

1.4 Approach

The approach taken to achieve the stated objectives was:

1. Identify appropriate test standards
2. Design and build a test rig to simulate a residential kitchen environment
3. Develop a test method for the test rig for the use of evaluating the effectiveness of a suppression system
4. Test an example of a local fire protection system to demonstrate the concept
5. Analyse test data
6. Refine test method and test rig as necessary
7. Summarise test results and experience for use in the cost effectiveness analysis stage of the research.

The results for this approach are summarised here.

2. LITERATURE REVIEW

The full literature review is included in the summary report for the cost effectiveness analysis of this research project (Robbins 2010). Current published test methods are summarised in this section. There is other research progressing in this area, and this is summarised in the second report of this series (Robbins 2010).

2.1 Current Standard Test Methods

There is currently no standard that lists all types of residential stove-top fire protection systems.

However Underwriters' Laboratory has published a document that outlines tests for residential stove-top top suppression systems, Subject UL 300A, *Outline of Investigation for Extinguishing System Units for Residential cooking Surfaces.* (UL300A 2006)

This outline provides test methods and performance requirements for stove-top top suppression systems.

The test apparatus consists of a stove-top and stove-top hood in isolation. Common kitchen materials that may contribute to a kitchen fire, such as cabinetry, counters or foods, are not included in the test.

The test method covers the parameters including: (UL300A 2006)

- Gas and electric stove-tops,
- Peanut and vegetable oil as representative foods,
- Various depths of each of the representative oil, and
- A stove-top of test cooking vessels: a cast iron skillet, stainless steel pan, stainless steel skillet, and steel pan.

Performance requirements of the extinguisher unit include (UL300A 2006):

- Complete extinguishment of flames in the test vessel,
- No observed re-ignition of the oil for 5 minutes after extinguishment,
- Temperature of the oil is reduced below the auto-ignition temperature after extinguishment,
- There is no splashing of the oil caused by the extinguisher unit (i.e. no drops of oil found around vessel), and
- Safe shutoff of the stove-top.

UL 300A (2006) also requires installation, operation and maintenance instructions for the unit.

3. DESCRIPTION OF EXPERIMENT APPARATUS

The electric stove-top consisted of 4 stove-top heating elements over an oven and warming tray configuration, as shown in Figure 1. Five thermocouples (A to E) were located on the surface of the stove-top. The thermocouple locations are included in the schematic in Figure 1. Four thermocouples (F to I) were located vertically over the centre of the heating element, as shown in the schematic in Figure 2. Two plate thermometers (Plate A and B) were located beside the heating element (Figure 2).

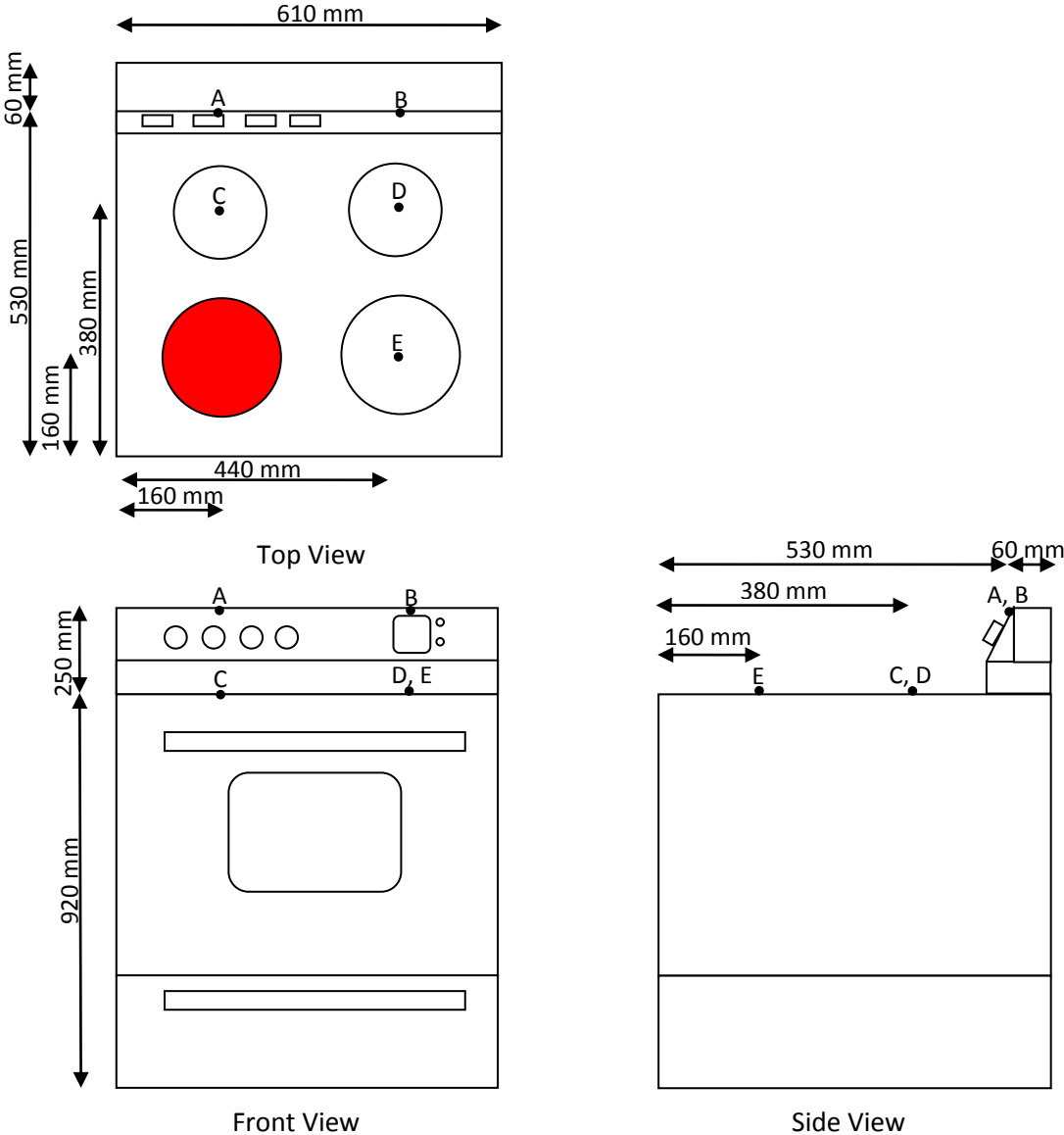

Figure 1: Schematic of the stove-top and surface thermocouple locations. Not to scale.

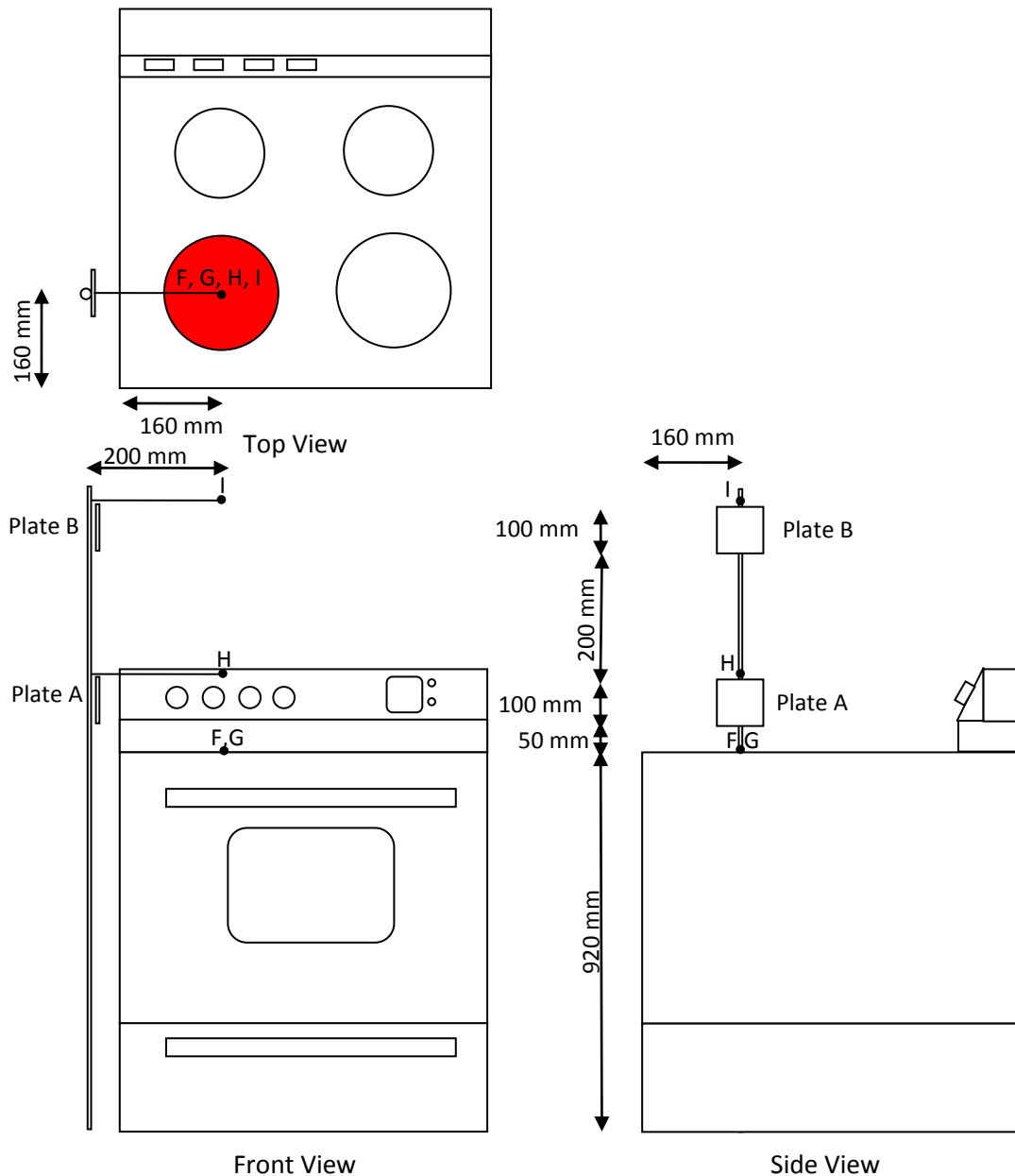

Figure 2: Schematic of stove-top and plate thermometer and thermocouple tree above the heating element.

Two orientations of the stove-top were considered: free-standing and within a partial (short-walled) corridor. Both orientations utilised the furniture calorimeter hood, with the extraction fan running (and analysis instruments running) or no extraction.

The free-standing orientation consisted of the stove-top located in the centre of the furniture calorimeter. The partial corridor orientation consisted of a 1.02 x 2.4 m corridor where the wall behind the stove-top went down to 1.0 m from the ceiling, the side walls went down 0.3 m below the ceiling and the end wall went 0.1 m down from the ceiling, as shown in the schematic in Figure 3. The entire partial corridor was located centrally under the hood of the furniture calorimeter. Within the partial corridor, one thermocouple was located directly above the centre of the heating element and two thermocouples were located along the centreline of the partial corridor (one at 0.77 m from the wall behind the stove-top and the other at 1.5 m from the wall), as shown in

Figure 3. For the tests summarised here, when required, a single sprinkler head was installed at 1.5 mm from the wall behind the stove-top, as indicated in Figure 3.

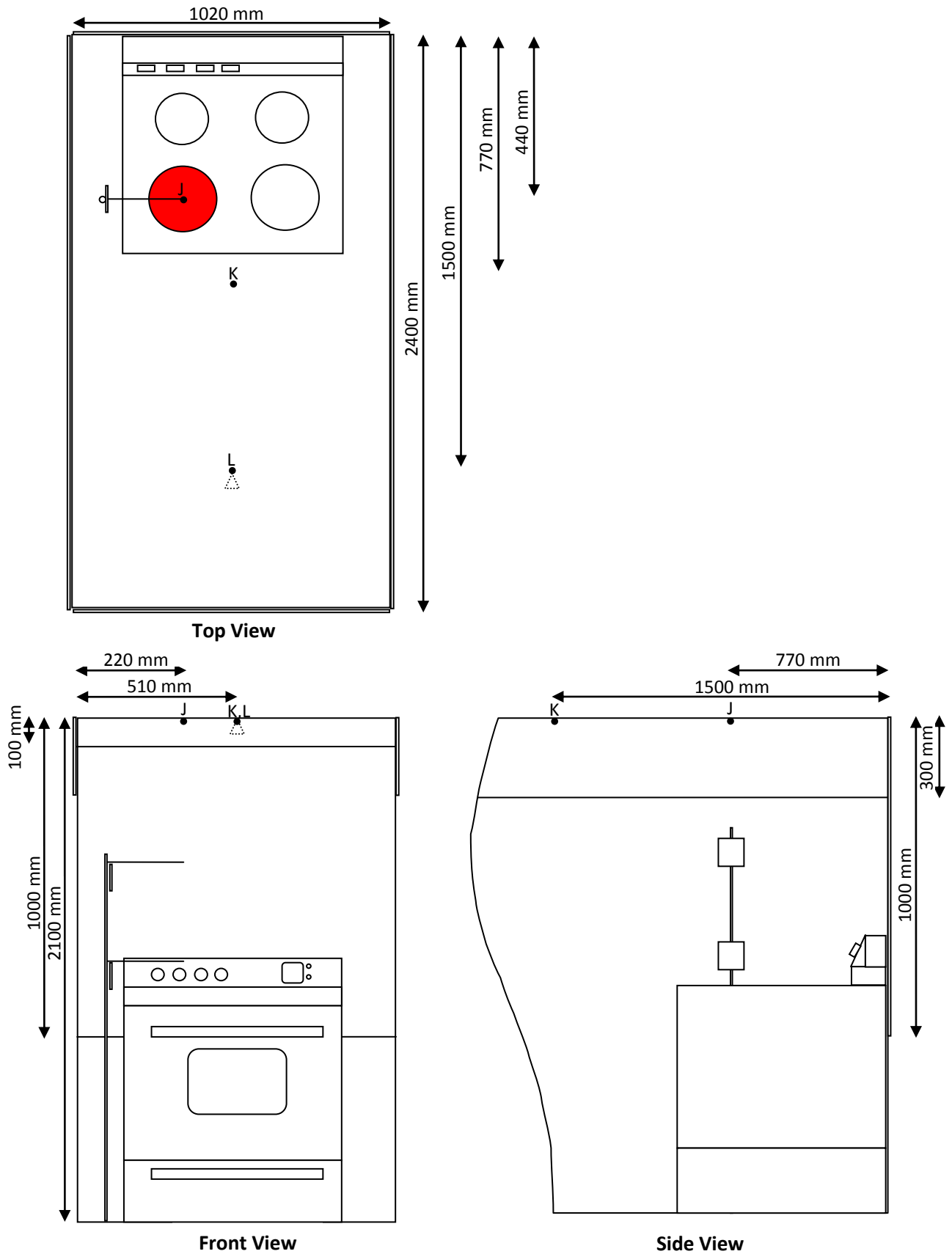

Figure 3: Schematic of the partial corridor orientation. Not to Scale.

3.1 Test Procedure

In each test:

- electricity to the stove-top was off at the start of each test,
- the oil was set in the cooking vessel on the heating element,
- if a fire protection system was to be tested, it was made active (if applicable, e.g. water supply turned on for a sprinkler, etc.)
- if the furniture calorimeter extraction fan was to be used, it was switched on before the test and the gas analysers calibrated,
- the gas analysers (if used), the datalogger for the thermocouples and the video recorder were turned on within 4 seconds,
- then power to the heating element was activated,
- for free-burning tests, where no fire protection system was in place, the oil in the cooking vessel was left to auto-ignite and then burn out,
- for fire protection system tests, the oil in the cooking vessel was left to auto-ignite and if the fire protection system was automatic it was left to activate without manual intervention, if the fire suppression 'system' was manual it was applied approximately 10 seconds after flaming was observed,
- thermocouple data was recorded at 1 s intervals, and
- heat release rate data was recorded at 3 s intervals.

The free-burning tests provide a measure of the challenge to the fire protection system and a baseline for comparison of the temperatures to the situations where suppression is present.

Following is a discussion of each of the experimental parameters that were considered in this investigation.

3.2 Test Matrix

Following is a description of the experimental parameters that were varied as part of the experimental program summarised here.

Three cooking elements were investigated:

- Electric stove-top
- Stand-alone (portable) electric element
- Stand-alone (portable) gas element

The stand-alone elements were initially used to perform a preliminary assessment on the behaviour of the elements during isolated fire tests. The majority of the experimental program was performed using a full-scale electric stove-top with four elements. The front left element, of 200 mm diameter, was used for all electric stove-top experiments.

No stove-top exhaust hoods were included in this experimental investigation. Instead it was considered that because there are various exhaust hood options available in the NZ market, the effect of these would be tested in the future. However at this initial stage was considered more important to investigate the influence of one type of

exhaust as well as gathering heat release information. Therefore the influence of a type of exhaust was included as part of the furniture calorimeter tests and were compared to the tests without the furniture calorimeter extract fans in operation.

Three cooking vessels were investigated:

- Skillet (or frying pan)
 - A 280 mm diameter by 50 mm high cast iron skillet.
- Small pan
 - A 150 mm diameter by 100 mm high stainless steel pan
- Stock pot
 - A 250 mm diameter by 200 mm high stainless steel stock pot.

These vessels were chosen as the closest common NZ matches to the vessels described in UL300A (2006). 'Pan' is used as a generic term for cooking vessel throughout this report.

Types of cooking oil:

- Canola oil
- Peanut oil

Canola oil was used for the majority of the experiments in this investigation. Canola and peanut oil were chosen for consistency with the fuel of UL300A (2006). Two amounts of oil were used in the test program; either 200 ml or 400 ml.

As a deviation from the description of the test method in UL300A (2006), the effect of food present in the cooking oil was also considered. Four foods were included in the investigation:

- 1 slice of white bread,
- 2 bacon rashers,
- 1 chipped potato, and
- 20 ml water (representing a freshly rinsed cooking vessel that has not been dried before use, or a food with a small amount of water present within it).

Potential fire protection methods included in this study for comparison were:

- De-energizing the cooking element at the first observation of flame (manually applied),
- Damp towel (manually applied),
- Fire blanket (manually applied),
- Hand-held dry powder extinguisher (manually applied),
- Single automatic residential sprinkler head (automatic system where the water supply was manually turned off after flameout was observed).

Excluding preliminary tests, 70 tests were performed. A list of these tests is included in Table 8 of Appendix B. A summary of selected tests is included in Section 4.

4. RESULTS

Examples of the summary of the results for selected tests are presented here. Results for each test are included in Appendix D. The selected tests summarised here are all electric stove-top tests. A summary of the tests are presented in Table 1.

Where multiple tests are shown, the data set for each test has been aligned such that the times of ignition are the same. This was based on the initial rise measured by the thermocouple located 100 mm above the centre of the pan and heating element.

Table 1: List of summarised kitchen stove-top fire tests

Section No.	Cooking Vessel	Wet or Dry Vessel	Oil Type	Amount of Oil	Fan	Free-standing or Corridor	Fire Protection
4.1	Skillet	Dry	No Oil	-	Off	Free-standing	-
4.2	Skillet	Dry	Canola	200 ml	Off	Free-standing	-
4.3	Skillet	Dry	Canola	200 ml	On	Free-standing	-
4.4	Skillet	Dry	Peanut	200 ml	On	Free-standing	-
4.5	Skillet	Dry	Canola	400 ml	On	Free-standing	-
4.5	Skillet	Dry	Canola	200 ml	On	Corridor	-
4.7	Skillet	Dry & Bacon	Canola	200 ml	On	Free-standing	-
4.8	Skillet	Wet 20 ml water	Canola	200 ml	On	Free-standing	-
4.9	Small Pan	Dry	Canola	200 ml	On	Free-standing	-
4.10	Stock Pot	Dry	Canola	200 ml	On	Free-standing	-
4.11	Skillet	Dry	Canola + 200 ml water at ignition	200 ml	On	Free-standing	-
4.12	Skillet	Dry	Canola	200 ml	On	Free-standing	De-energize after ignition
4.13	Skillet	Dry	Canola	200 ml	On	Free-standing	Fire blanket & de-energize
4.14	Skillet	Dry	Canola	200 ml	On	Free-standing	Dry powder extinguisher
4.15	Skillet	Dry	Canola	200 ml	On	Corridor	Sprinkler
4.16	Skillet	Dry	Canola	400 ml	On	Corridor	Sprinkler
4.17	Skillet	Dry	Canola	200 ml	Off	Corridor	Sprinkler

4.1 Skillet with No Oil, No Fan (Test 28)

This test was a free-standing electric stove-top under the furniture calorimeter hood with the fan turned off. The skillet with no oil was present on the powered electric element. This test formed a baseline for the measured temperatures for the setup without any flaming of potential fuel. Test 28 is an example of this scenario. The measured temperatures are shown in Figure 4. Estimates of the incident radiation on the plate thermometers are shown in Figure 5. Differences between time step measurements of each of the temperatures are shown in Figure 6. Ratios of each of the variable temperatures to the temperatures at the time of ignition are shown in Figure 7.

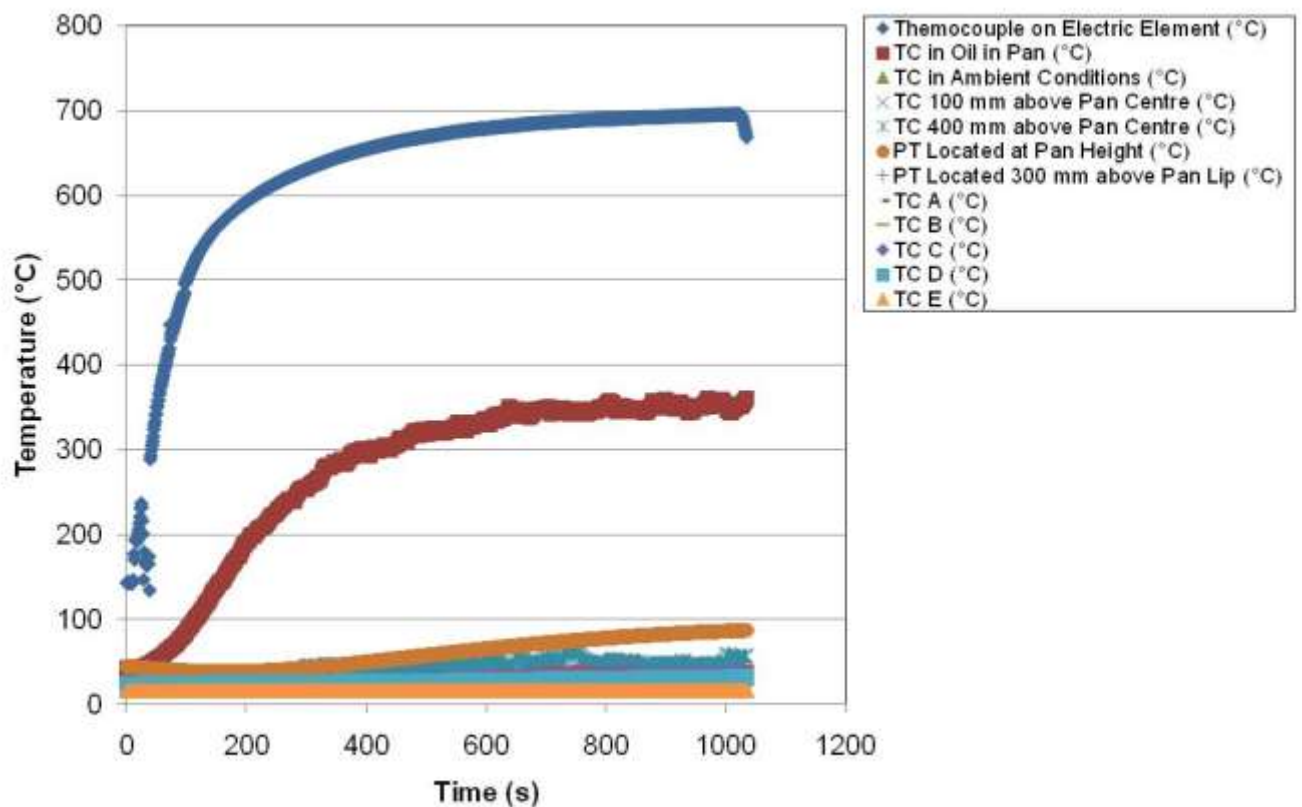

Figure 4: Measured temperatures of the thermocouples and plate thermometers for a dry skillet containing no oil on an electric stove-top (Test 28).

4.1.1 Analysis

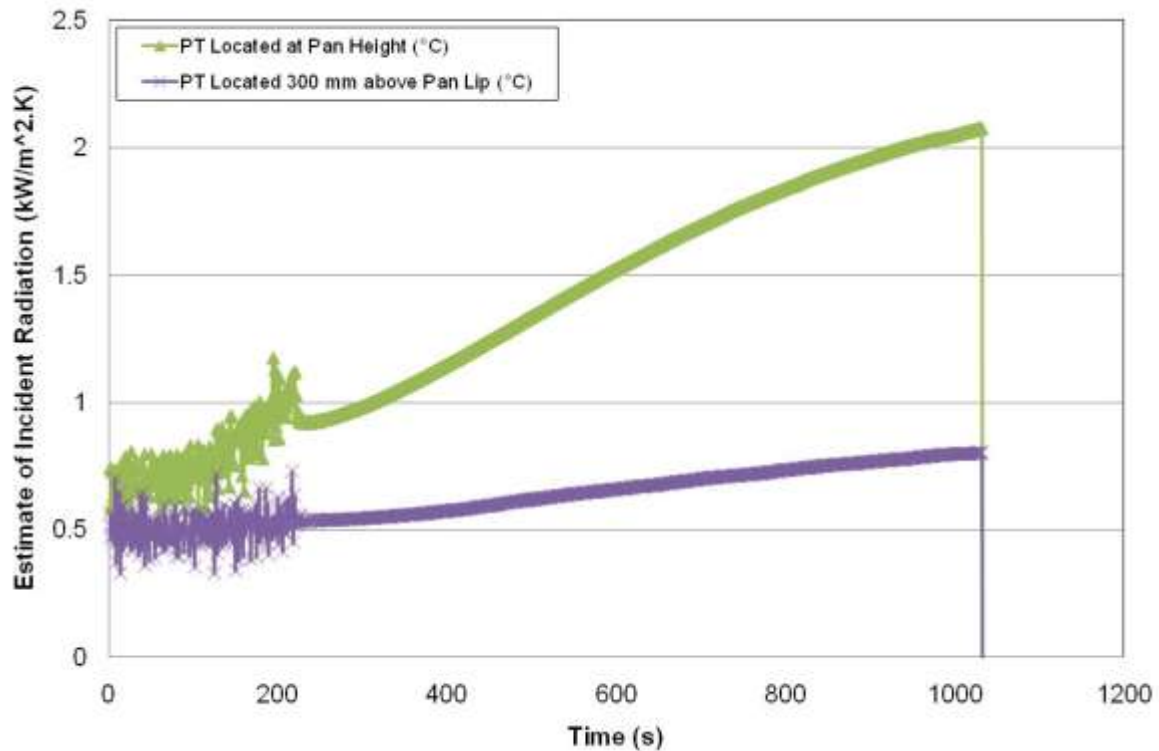

Figure 5: Estimates of the incident radiation for the plate thermometers located 50 mm and 350 mm above the surface of the stove-top for a dry skillet containing no oil on an electric stove-top (Test 28).

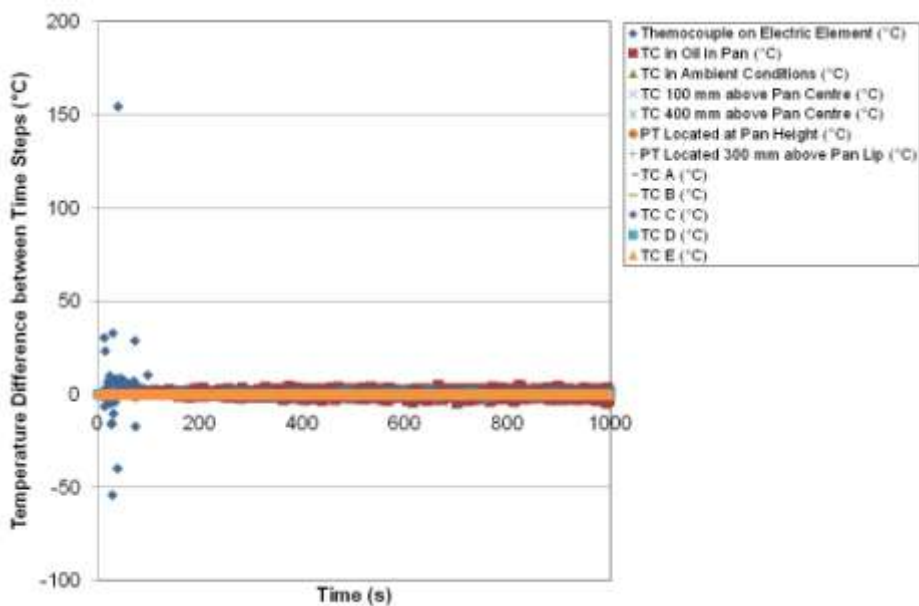

Figure 6: Differences of each of the variable temperatures to between sequential time steps for a dry skillet containing no oil on an electric stove-top (Test 28).

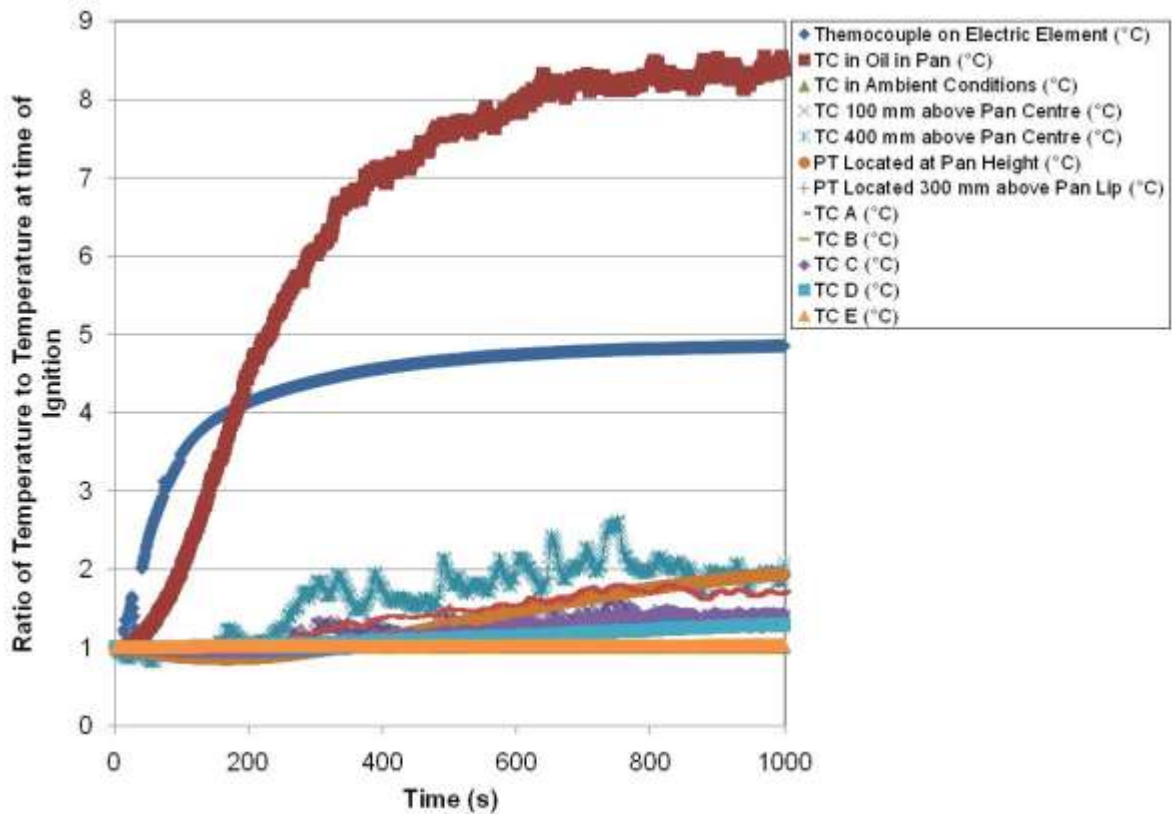
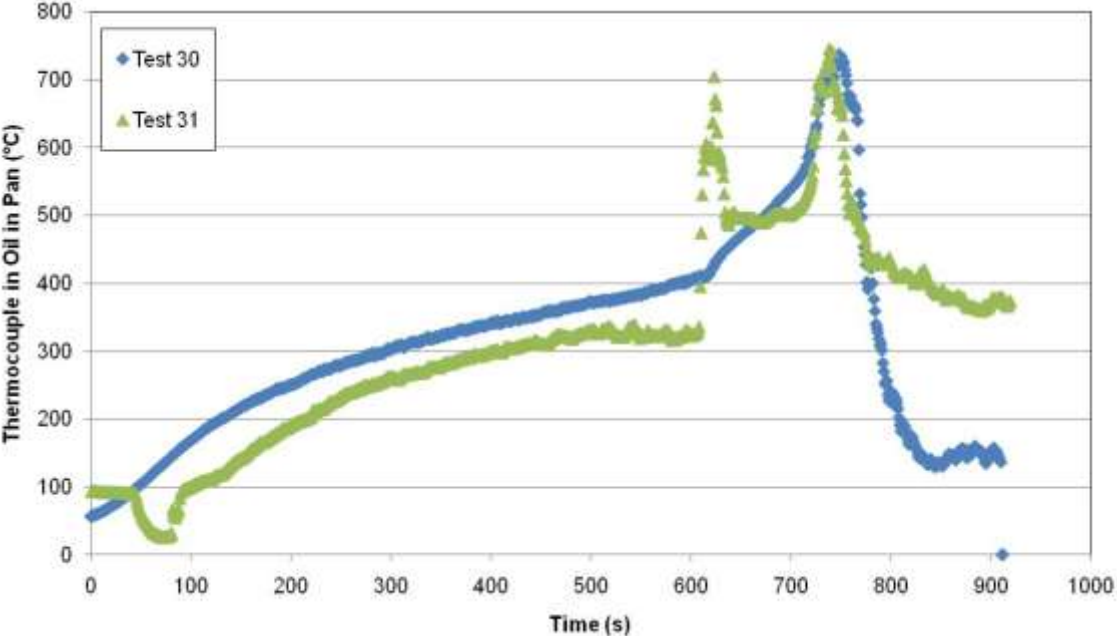

Figure 7: Ratios of each of the variable temperatures to the temperatures at the time of ignition for a dry skillet containing no oil on an electric stove-top (Test 28).

4.2 Skillet with 200 ml Canola Oil, No Fan (Tests 30 & 31)

This test was a free-standing electric stove-top under the furniture calorimeter hood with the fan turned off. The skillet, with 200 ml of canola oil, was present on the powered electric element. This test formed a baseline for the measured temperatures for the setup with flaming of 200 ml canola oil with no fan running. Tests 30 and 31 are examples of this scenario. The thermocouple measurements in the oil and above the centre of the pan are shown in Figure 8. Plate thermometer temperature measurements are shown in Figure 9. Thermocouple measurements from the locations on the surface of the stove-top are shown in Figure 10. Estimates of the incident radiation on the plate thermometers are shown in Figure 11. An example of the temperature differences between sequential time steps for each of the variables recorded is shown in Figure 12 for Test 30 (where the time shown is based on the original test data, as included in Appendices C and D). An example of the ratios of temperatures to the temperature at the time of ignition for each of the variables recorded is shown in Figure 13 for Test 30 (where the time shown is based on the original test data, as included in Appendices C and D).



(a)

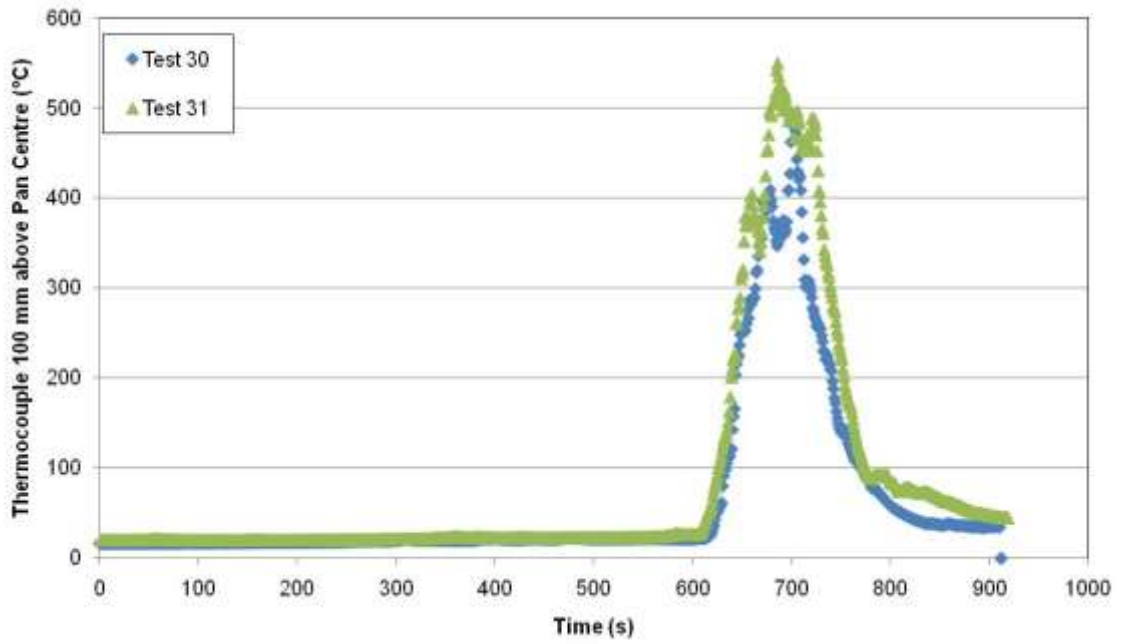

(b)

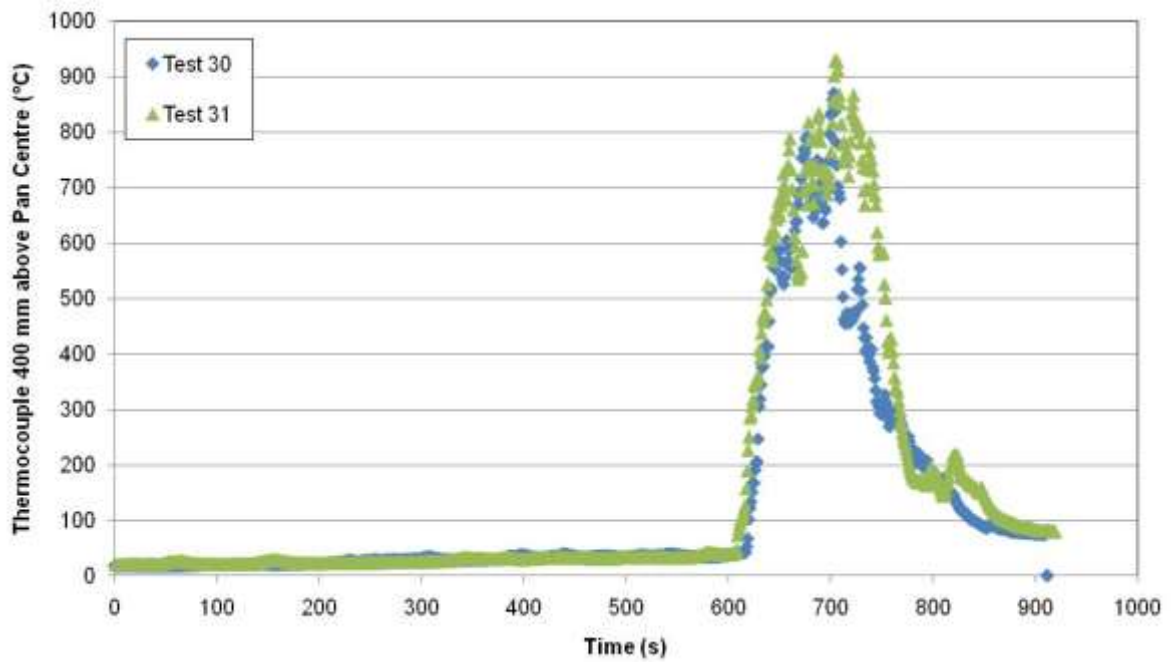

(c)

Figure 8: Thermocouple measurements for the thermocouple located (a) in the oil in the skillet, (b) 100 mm above the centre of the skillet, and (c) 400 mm above the centre of the skillet for Tests 30 and 31.

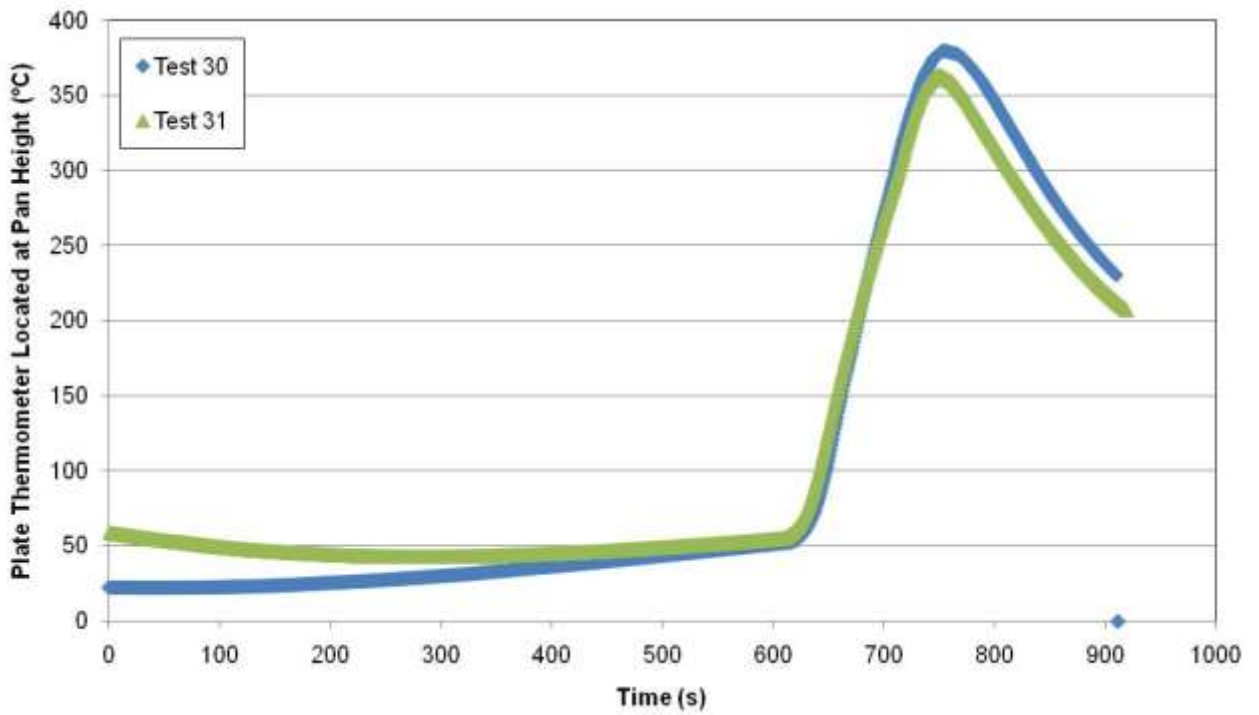

(a)

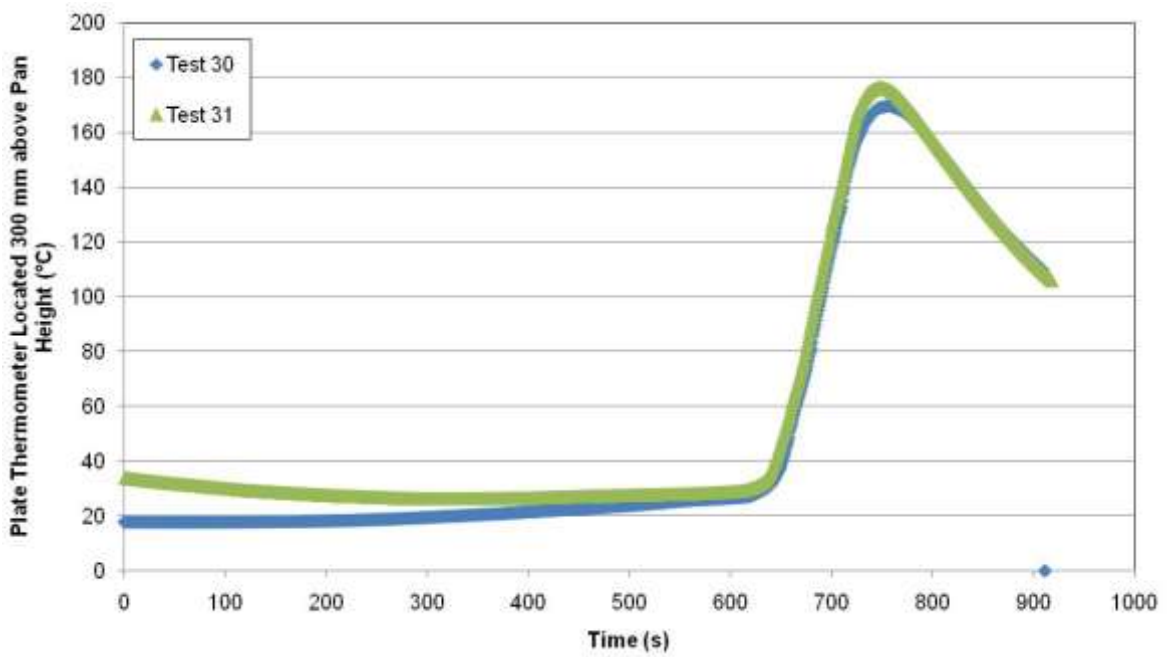

(b)

Figure 9: Plate thermometer temperature measurements for (a) at the height of the lip of the skillet, and (b) 300 mm above the lip of the skillet for Tests 30 and 31.

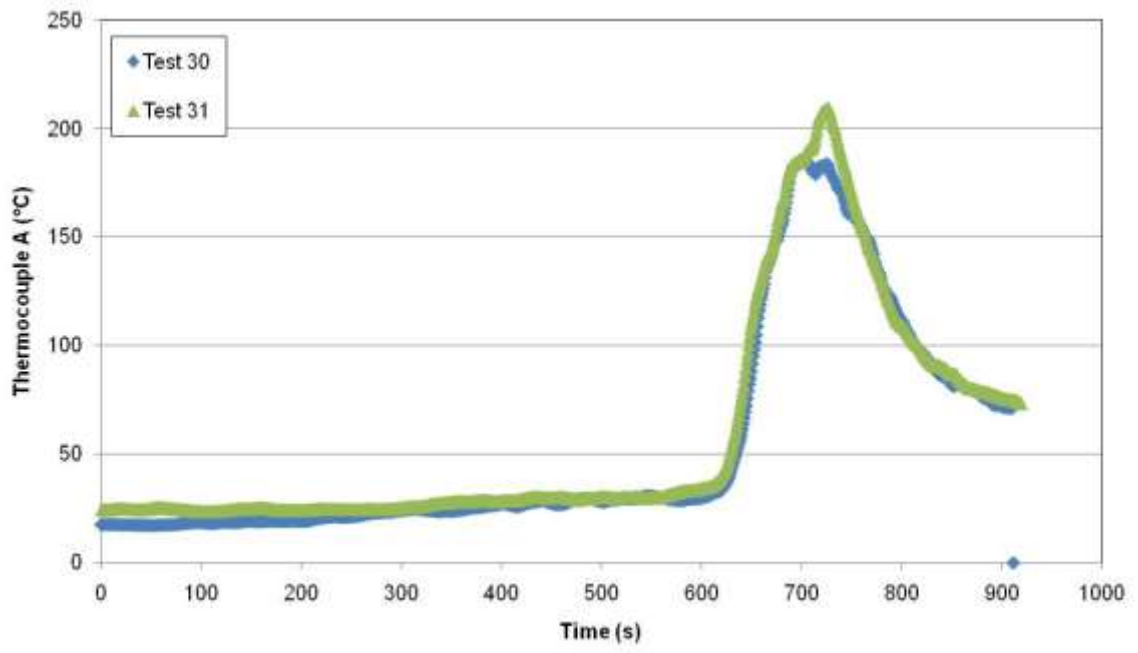

(a)

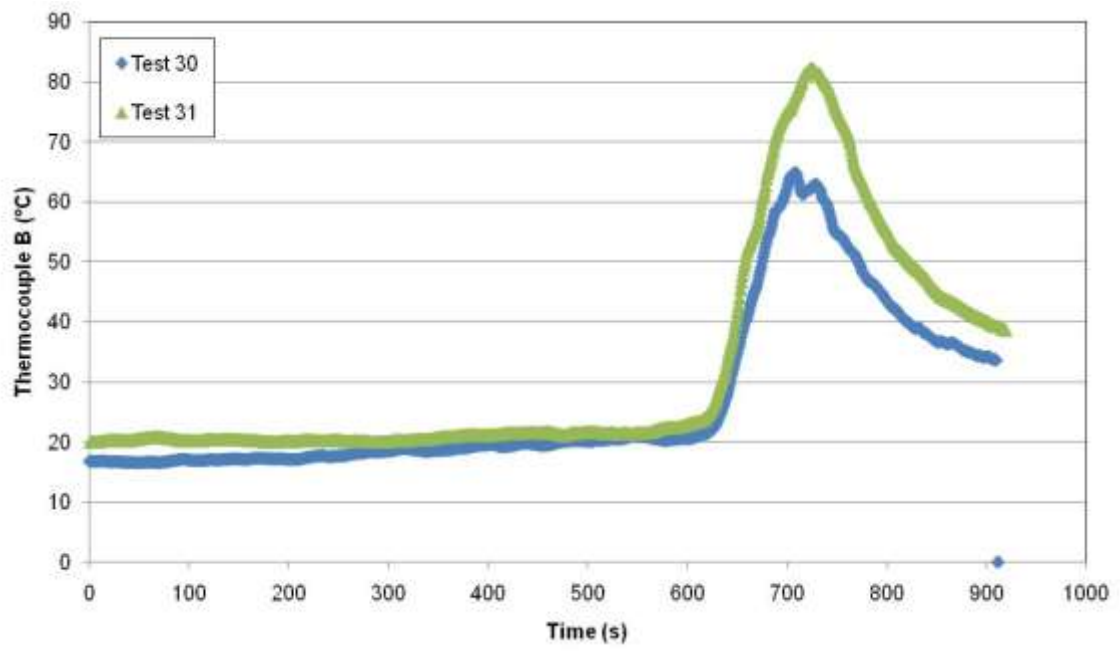

(b)

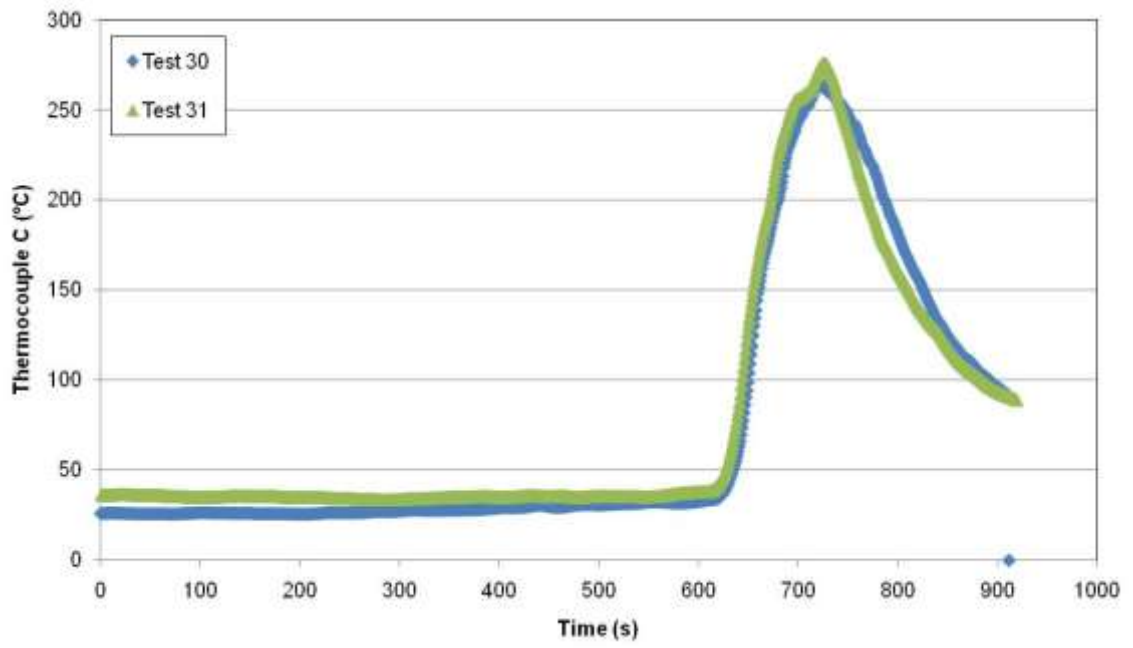

(c)

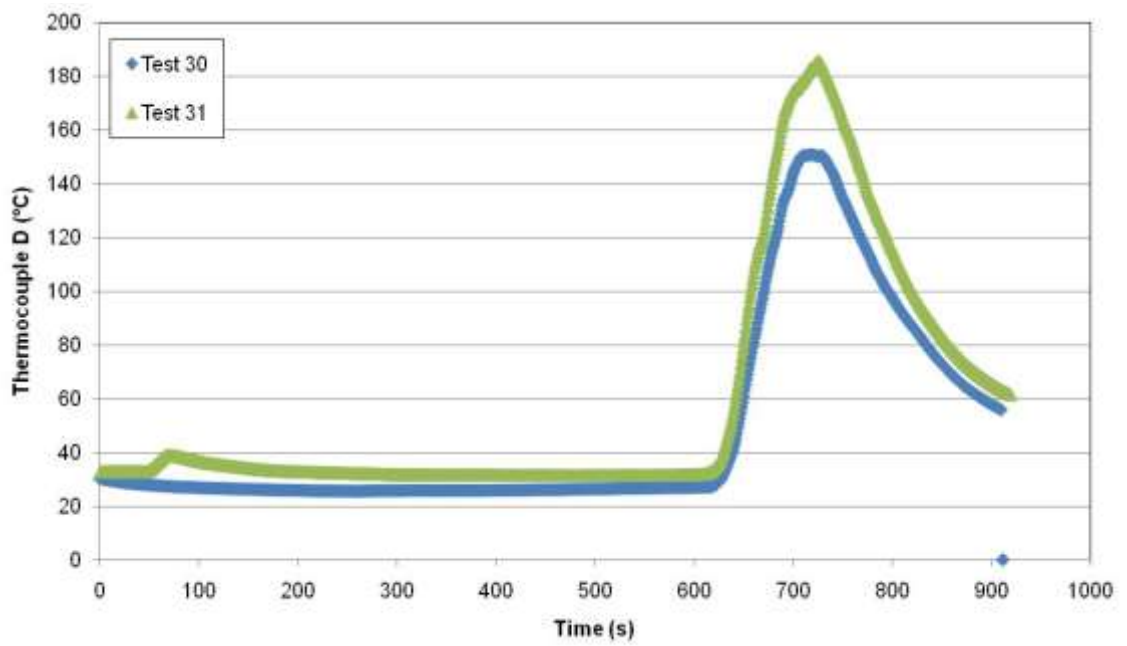

(d)

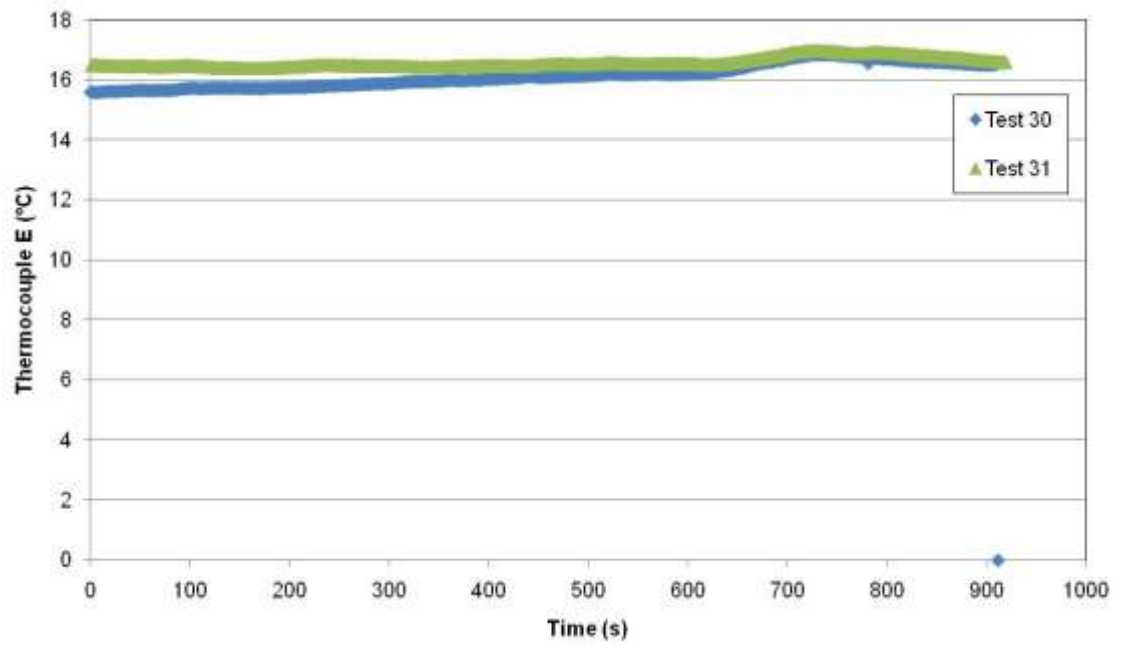

(e)

Figure 10: Thermocouple measurements of (a) thermocouple A, (b) thermocouple B, (c) thermocouple C, (d) thermocouple D, and (e) thermocouple E for Tests 30 and 31.

4.2.1 Analysis

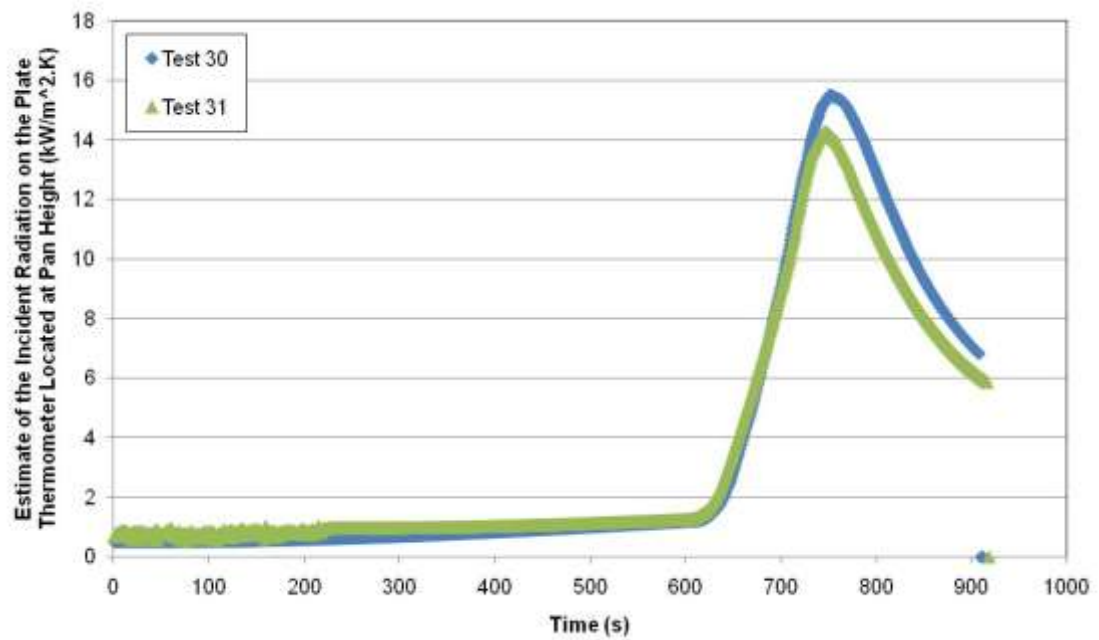

(a)

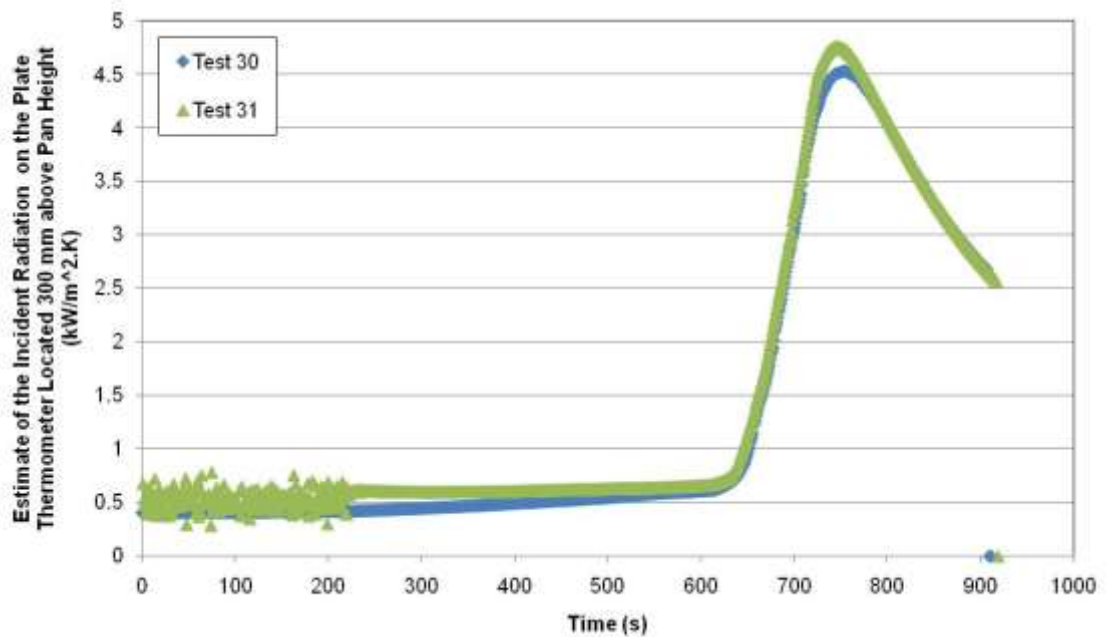

(b)

Figure 11: Estimates of the incident radiation on the plate thermometer (a) at the height of the lip of the skillet, and (b) 300 mm above the lip of the skillet for Tests 30 and 31.

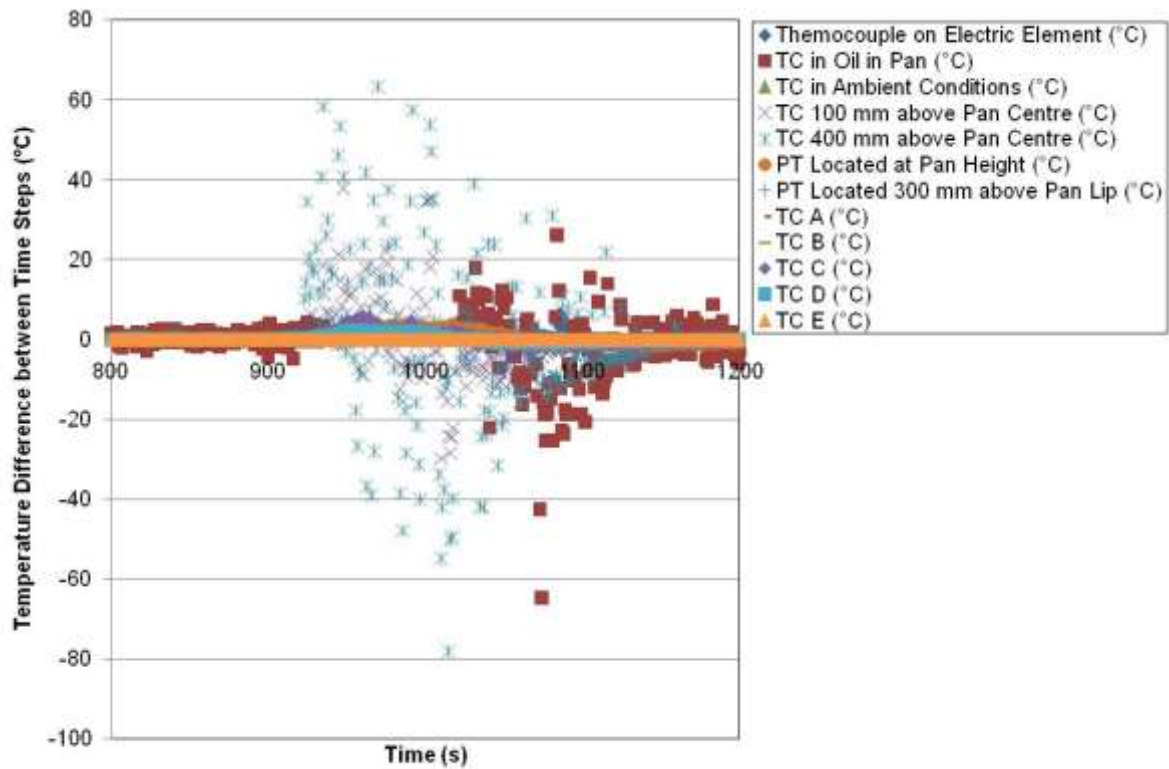

Figure 12: Examples of the differences of each of the variable temperatures to between sequential time steps for Test 30.

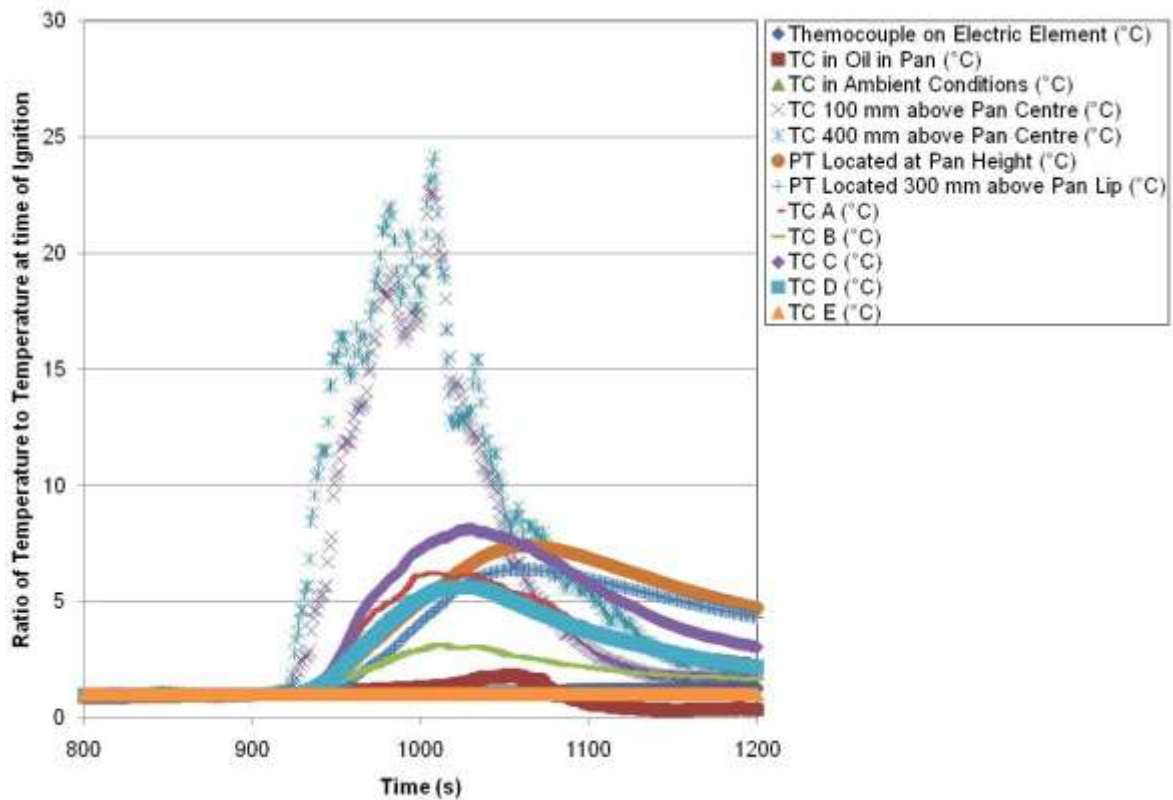
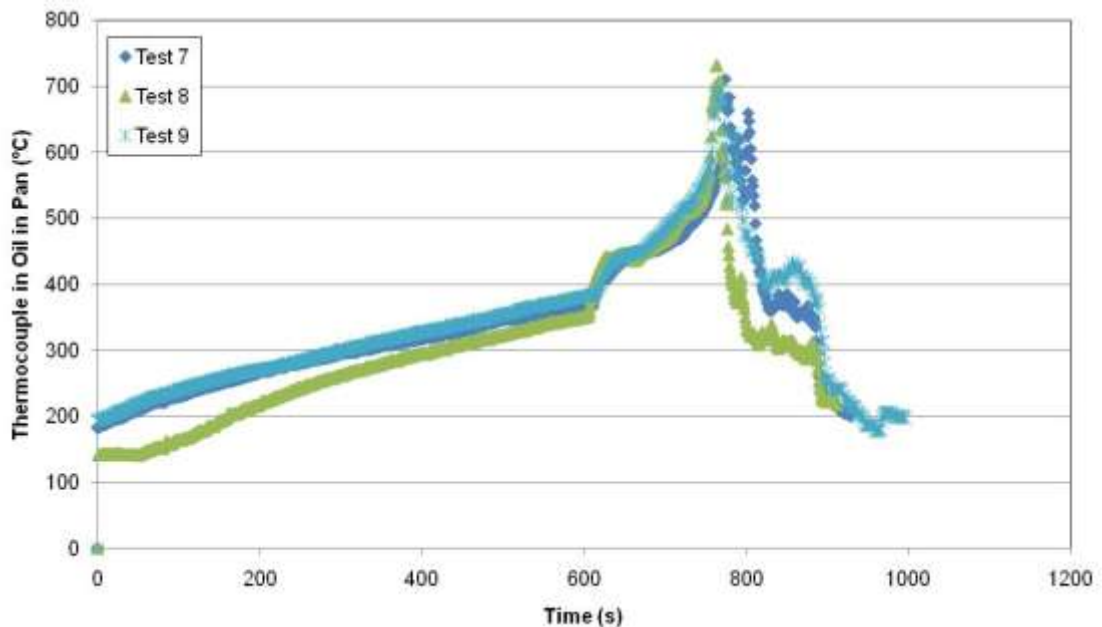

Figure 13: Examples of the ratios of each of the variable temperatures to the temperatures at the time of ignition for Test 30.

4.3 Skillet with 200 ml Canola Oil, Fan (Tests 7 – 9)

This test was a free-standing electric stove-top under the furniture calorimeter hood with the fan turned on (also allowing data to be collected for the heat release rate). The skillet, with 200 ml of canola oil, was present on the powered electric element. This test formed a baseline for the measured temperatures for the setup with flaming of 200 ml canola oil with the extraction fan running. Tests 7 to 9 are examples of this scenario. The thermocouple measurements in the oil and above the centre of the pan are shown in Figure 14. Plate thermometer temperature measurements are shown in Figure 15. Heat release rates based on oxygen calorimetry are shown in Figure 16. Estimates of the incident radiation on the plate thermometers are shown in Figure 17. An example of the temperature differences between sequential time steps for each of the variables recorded is shown in Figure 18 for Test 8 (where the time shown is based on the original test data, as included in Appendices C and D). An example of the ratios of temperatures to the temperature at the time of ignition for each of the variables recorded is shown in Figure 19 for Test 8 (where the time shown is based on the original test data, as included in Appendices C and D).



(a)

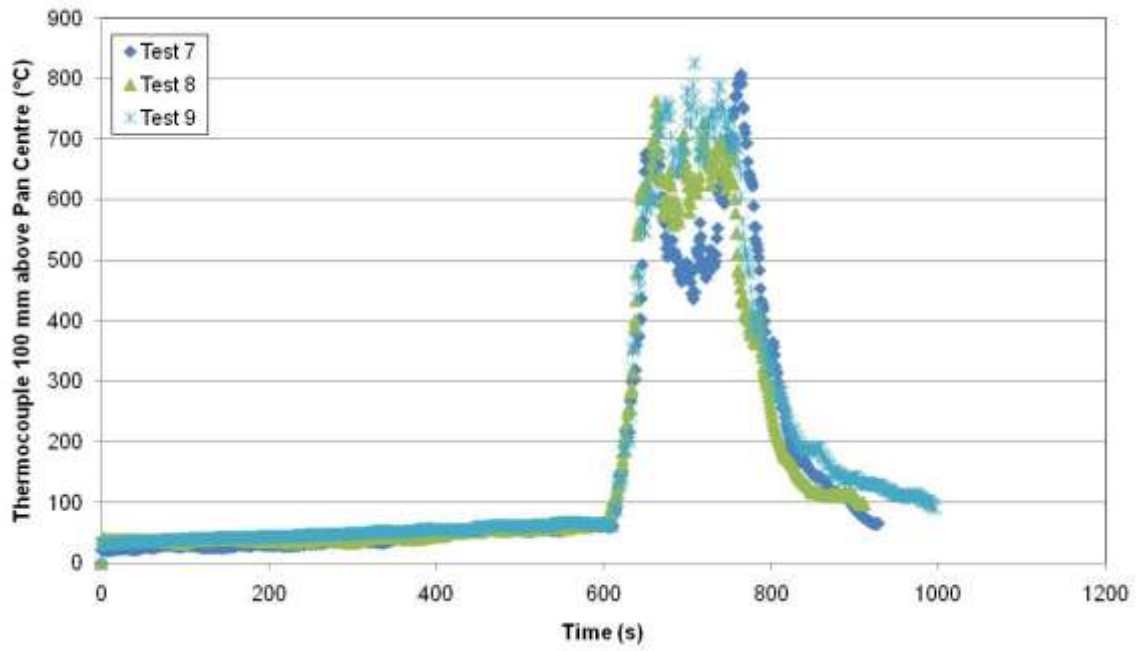

(b)

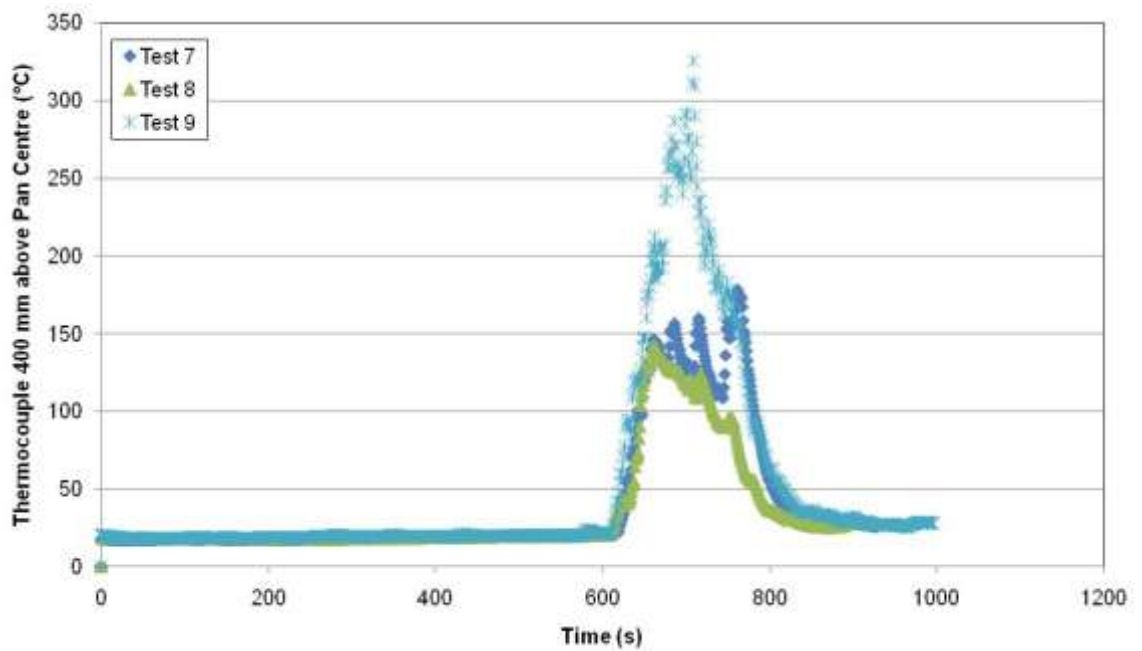

(c)

Figure 14: Thermocouple measurements for the thermocouple located (a) in the oil in the skillet, (b) 100 mm above the centre of the skillet, and (c) 400 mm above the centre of the skillet for Tests 7 – 9.

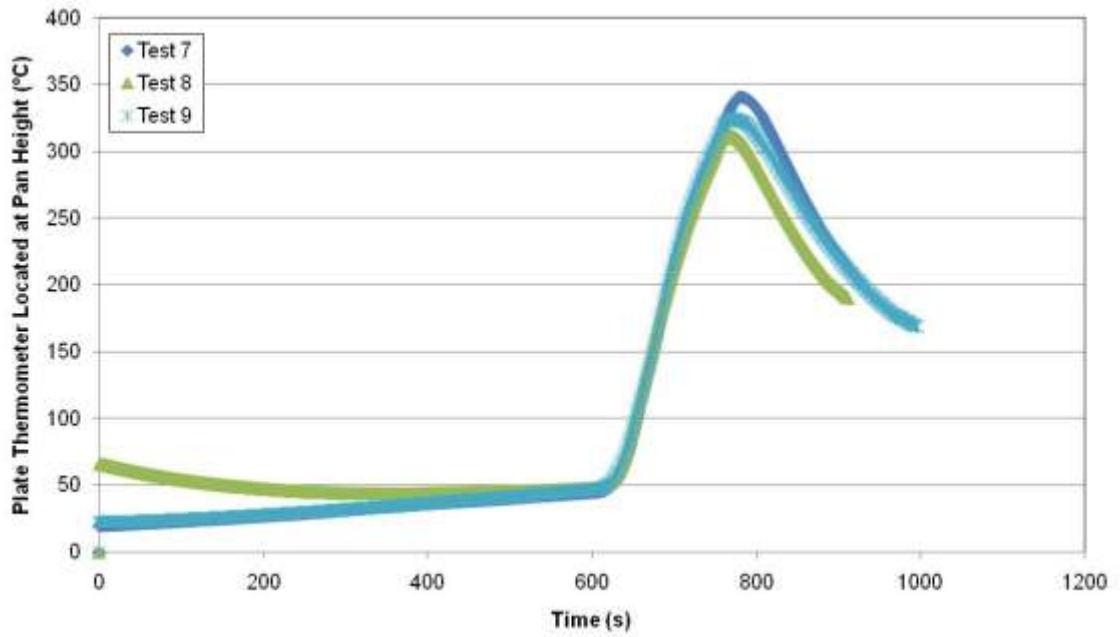

(a)

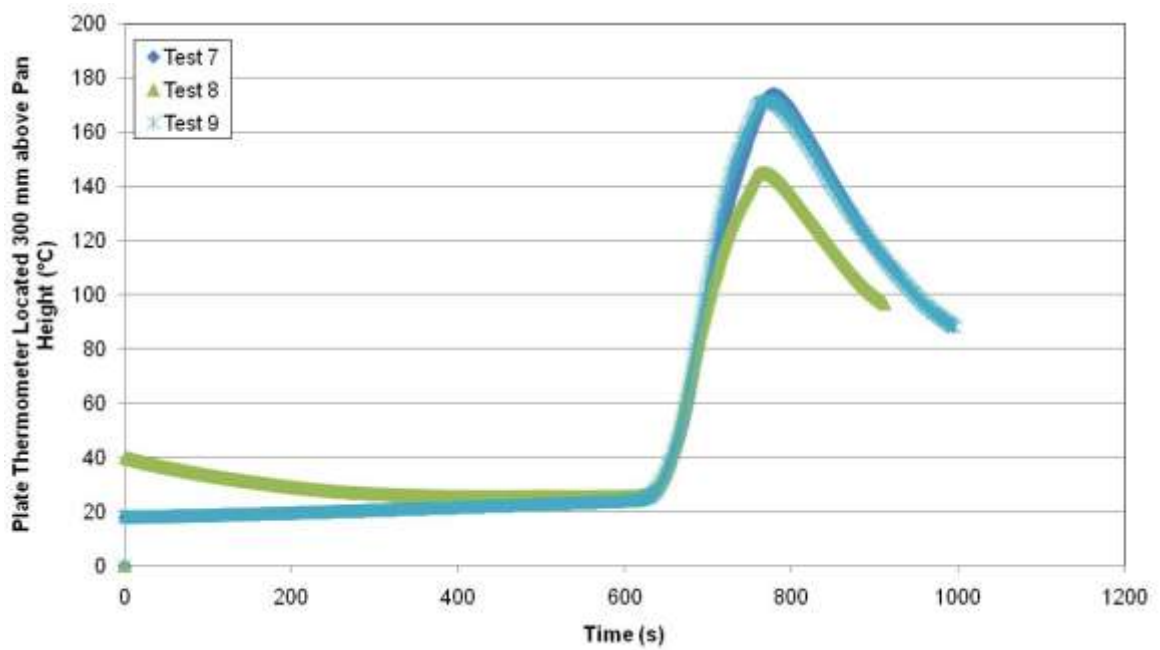

(b)

Figure 15: Plate thermometer temperature measurements for (a) at the height of the lip of the skillet, and (b) 300 mm above the lip of the skillet.

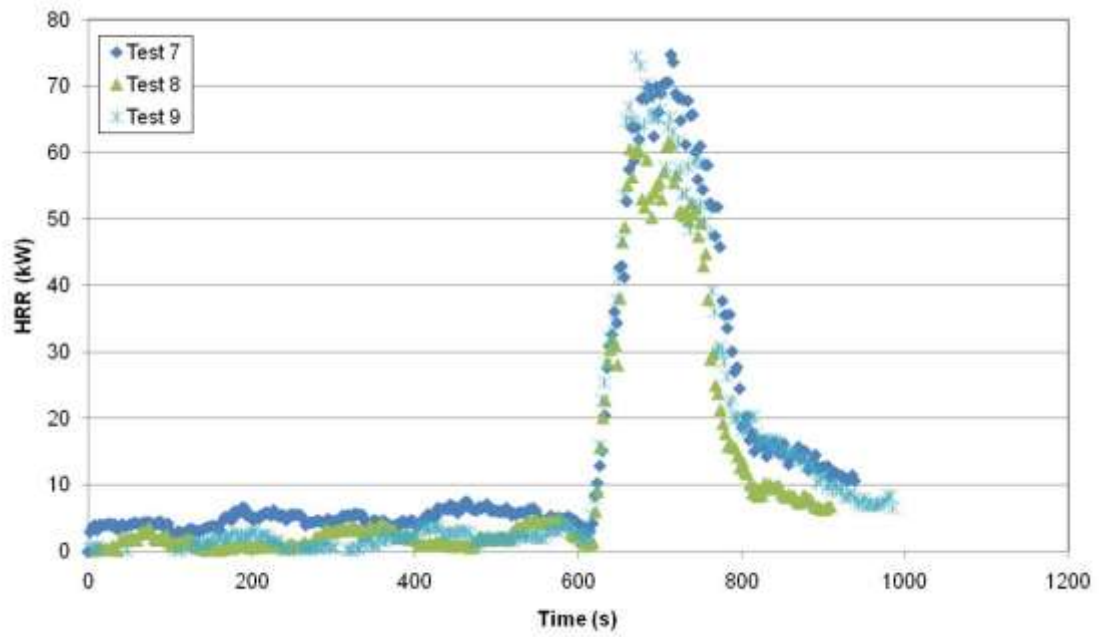
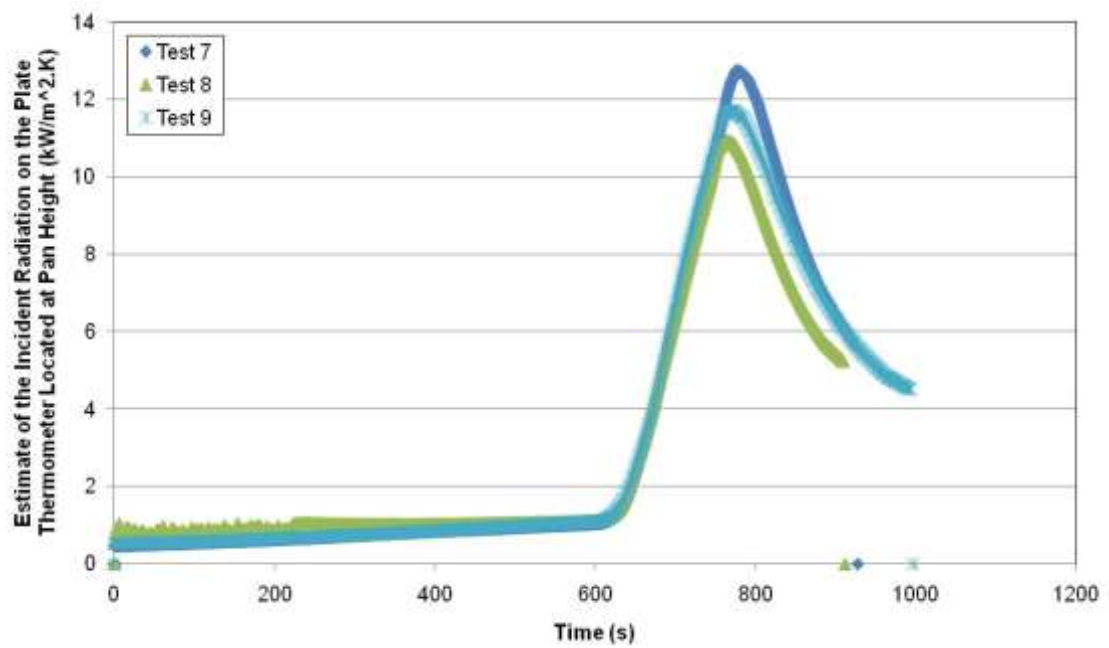
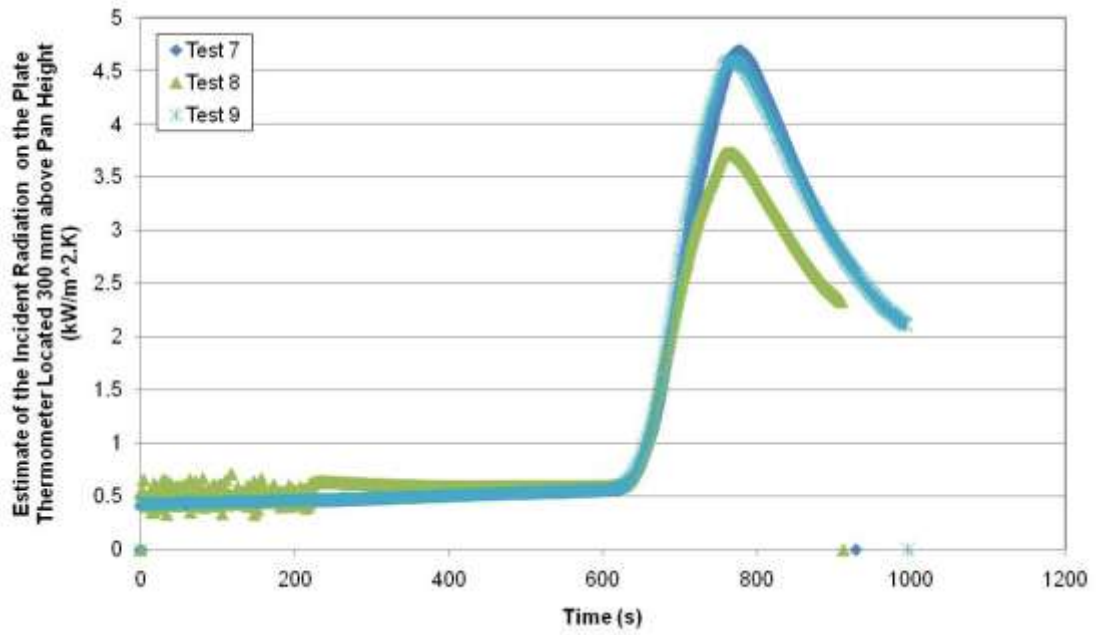

Figure 16: Heat release rates estimated from oxygen calorimetry for Tests 7 – 9.

4.3.1 Analysis



(a)



(b)

Figure 17: Estimates of the incident radiation on the plate thermometer (a) at the height of the lip of the skillet, and (b) 300 mm above the lip of the skillet.

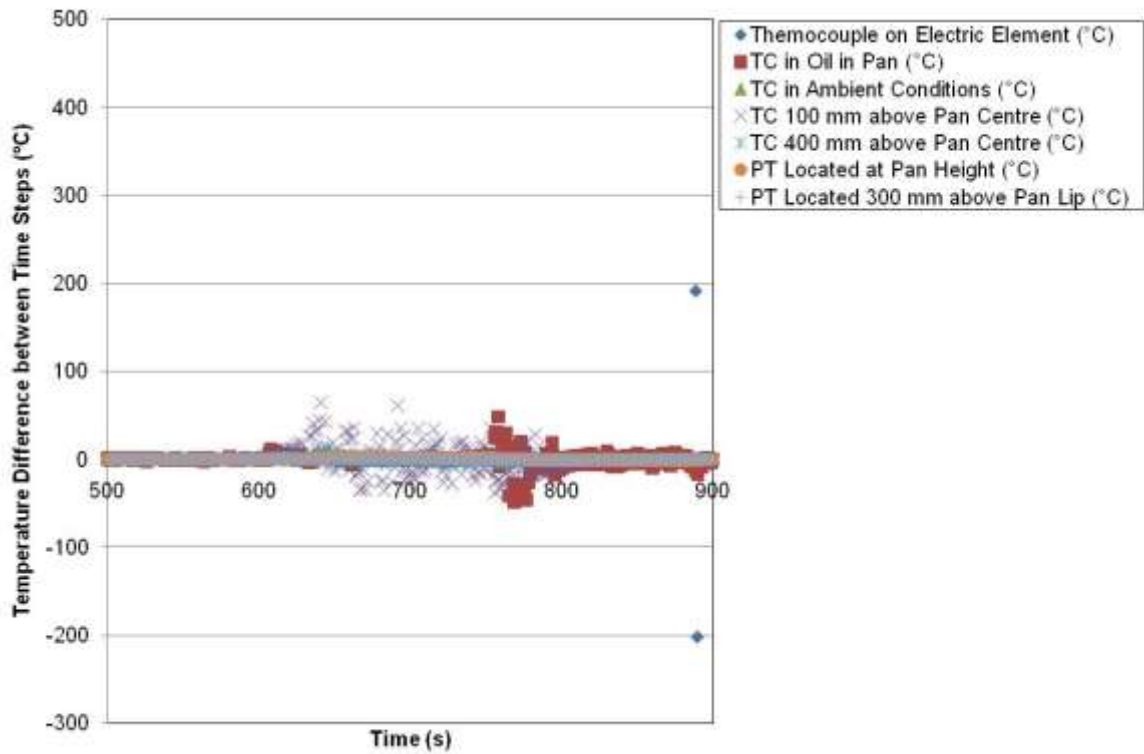

Figure 18: Examples of the differences of each of the variable temperatures to between sequential time steps for Test 8.

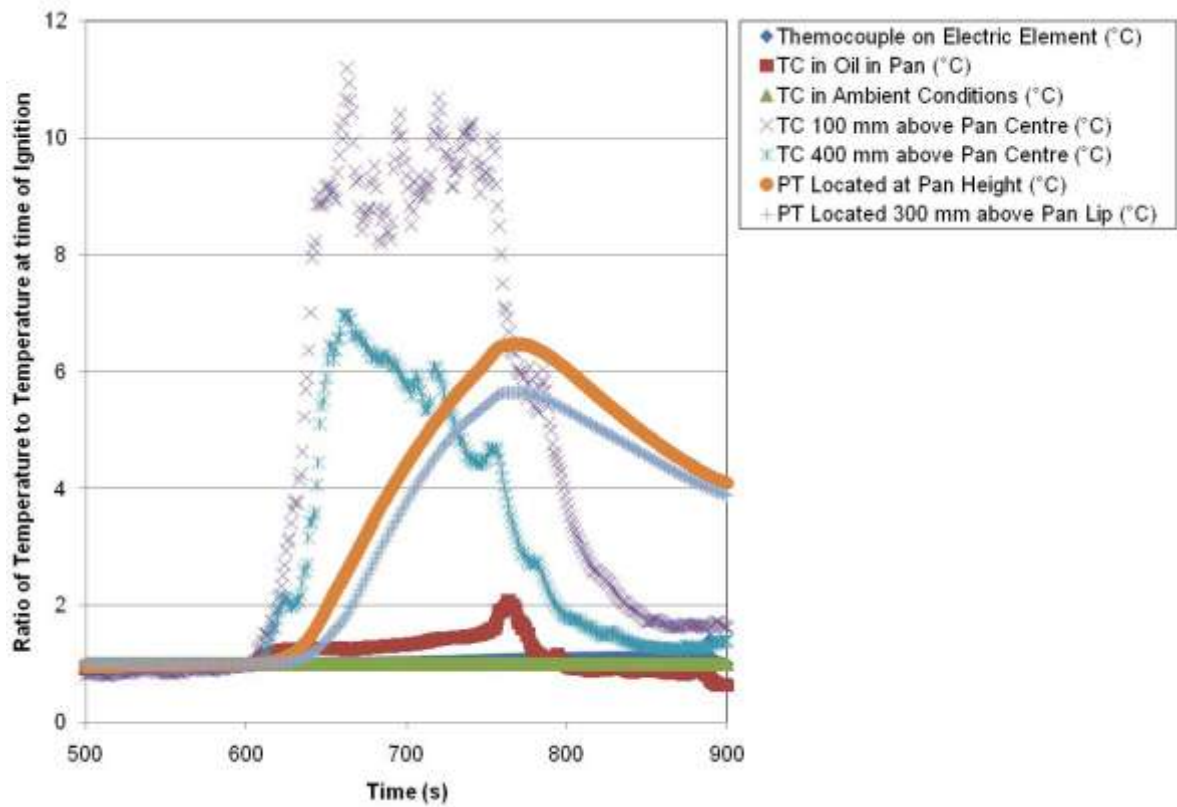
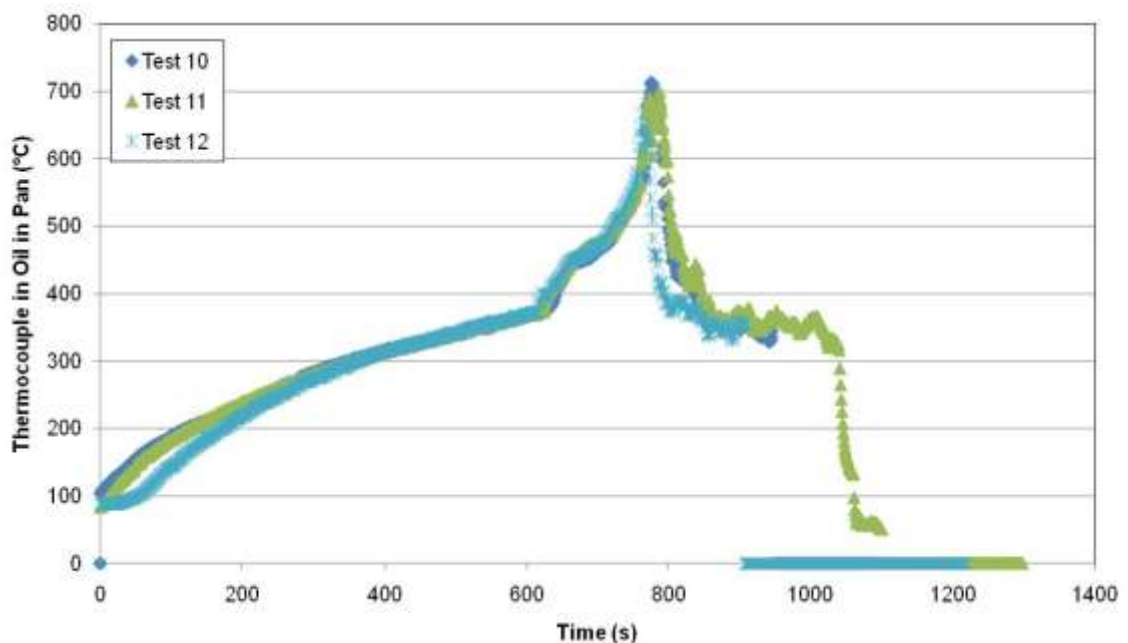

Figure 19: Examples of the ratios of each of the variable temperatures to the temperatures at the time of ignition for Test 8.

4.4 Skillet with 200 ml Peanut Oil, Fan (Tests 10 – 12)

This test was a free-standing electric stove-top under the furniture calorimeter hood with the fan turned on (also allowing data to be collected for the heat release rate). The skillet, with 200 ml of peanut oil, was present on the powered electric element. This test formed a comparison with the results where canola oil was used. Tests 10 to 12 are examples of this scenario. The thermocouple measurements in the oil and above the centre of the pan are shown in Figure 20. Plate thermometer temperature measurements are shown in Figure 21. Thermocouple measurements from the locations on the surface of the stove-top are shown in Figure 22. Heat release rates based on oxygen calorimetry are shown in Figure 23. Estimates of the incident radiation on the plate thermometers are shown in Figure 24. An example of the temperature differences between sequential time steps for each of the variables recorded is shown in Figure 25 for Test 11 (where the time shown is based on the original test data, as included in Appendices C and D). An example of the ratios of temperatures to the temperature at the time of ignition for each of the variables recorded is shown in Figure 26 for Test 11 (where the time shown is based on the original test data, as included in Appendices C and D).



(a)

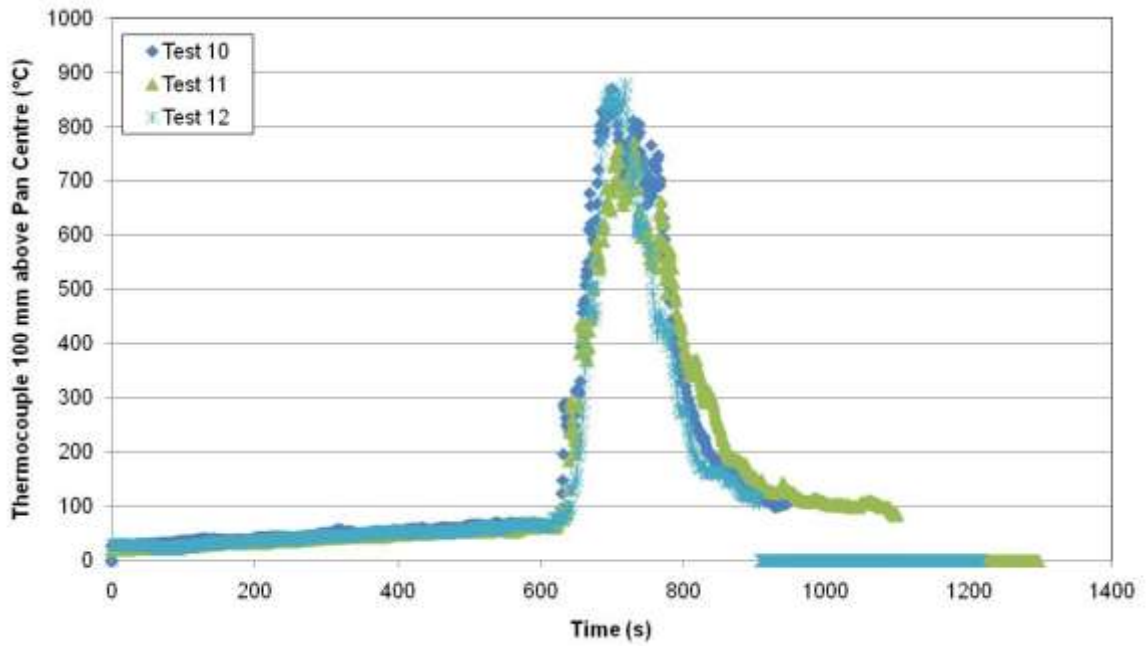

(b)

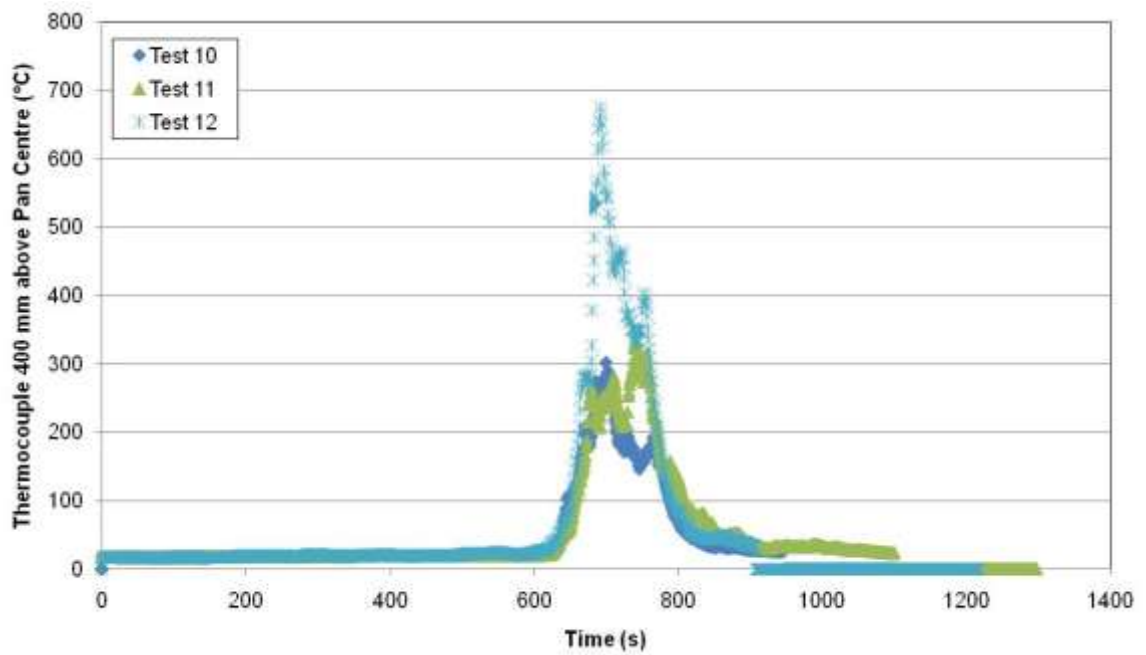

(c)

Figure 20: Thermocouple measurements for the thermocouple located (a) in the oil in the skillet, (b) 100 mm above the centre of the skillet, and (c) 400 mm above the centre of the skillet for Tests 10 – 12.

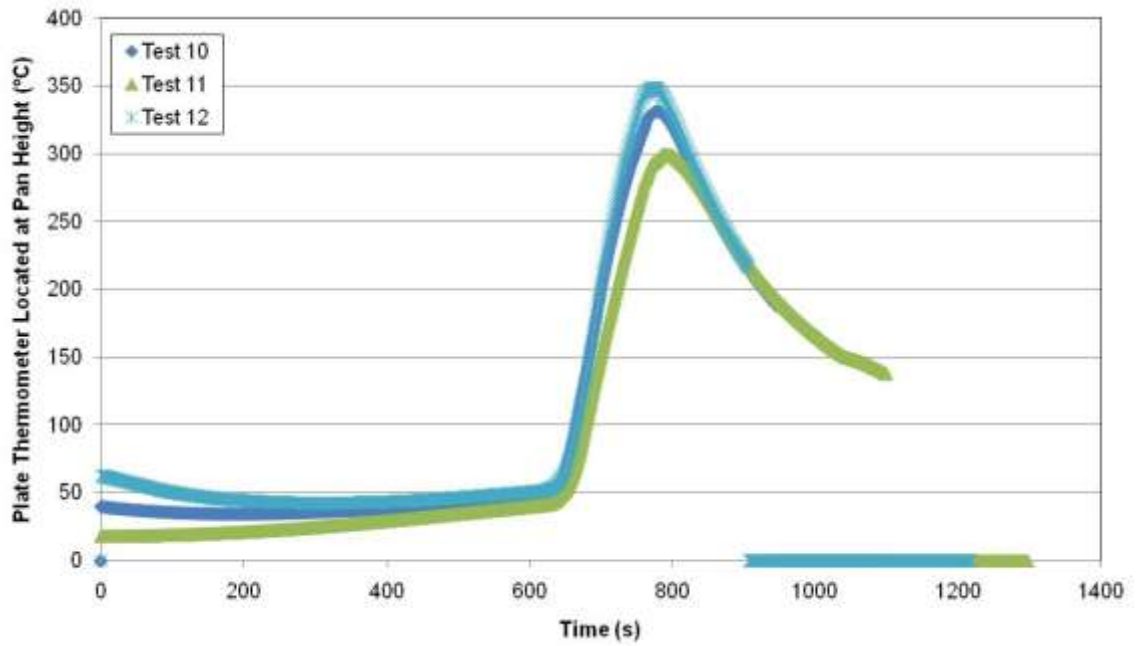

(a)

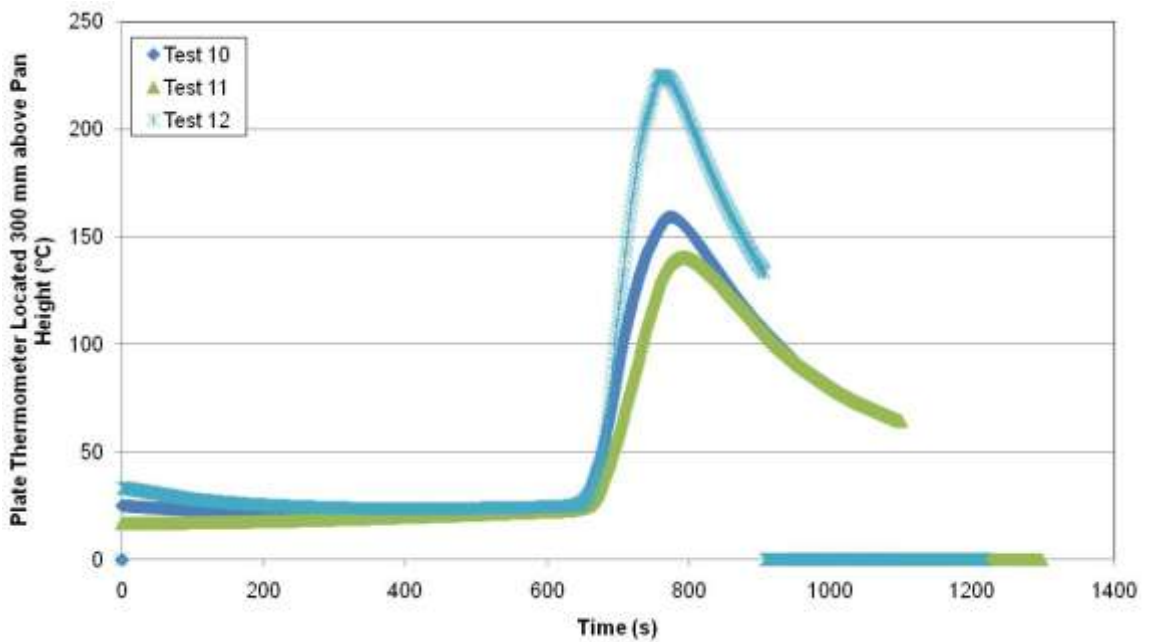

(b)

Figure 21: Plate thermometer temperature measurements for (a) at the height of the lip of the skillet, and (b) 300 mm above the lip of the skillet for Tests 10 – 12.

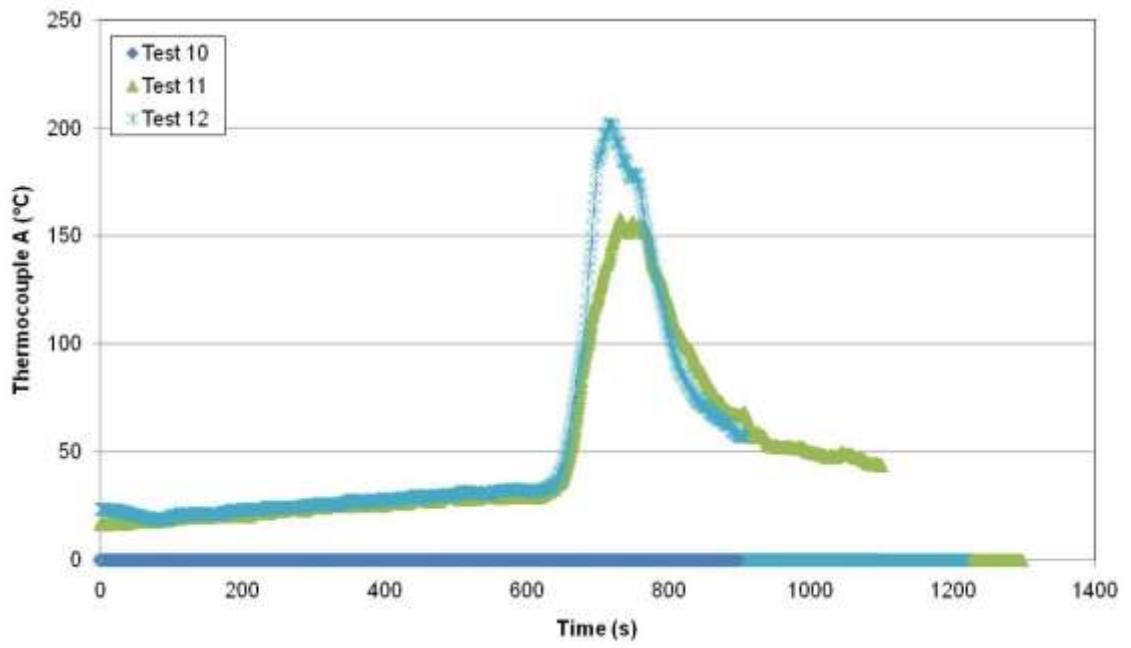

(a)

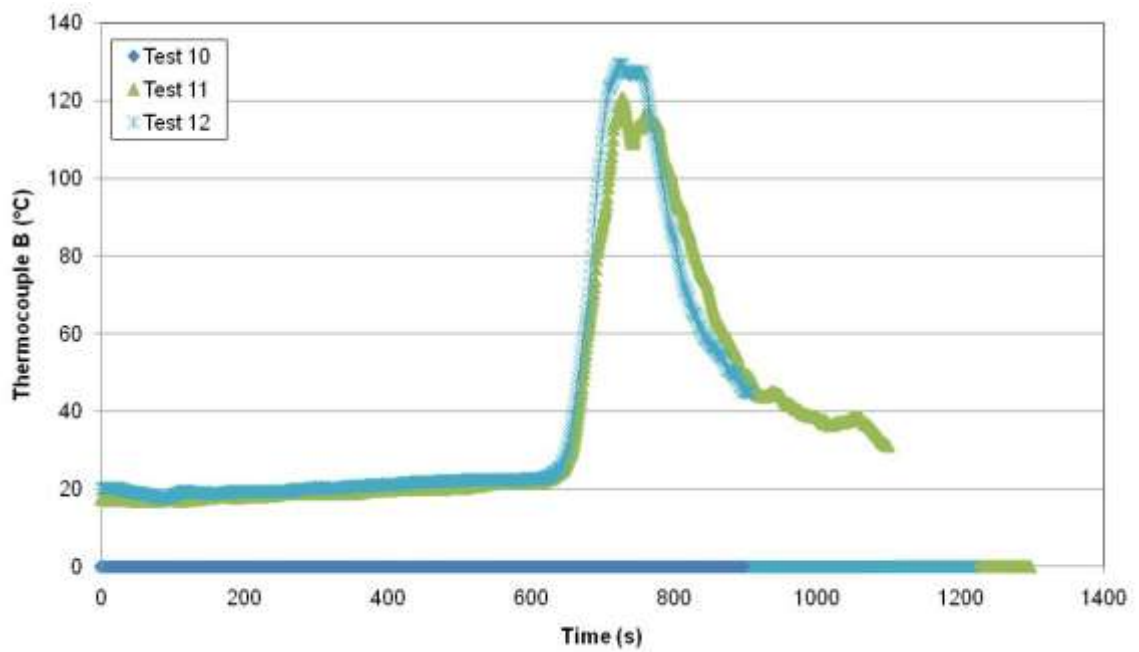

(b)

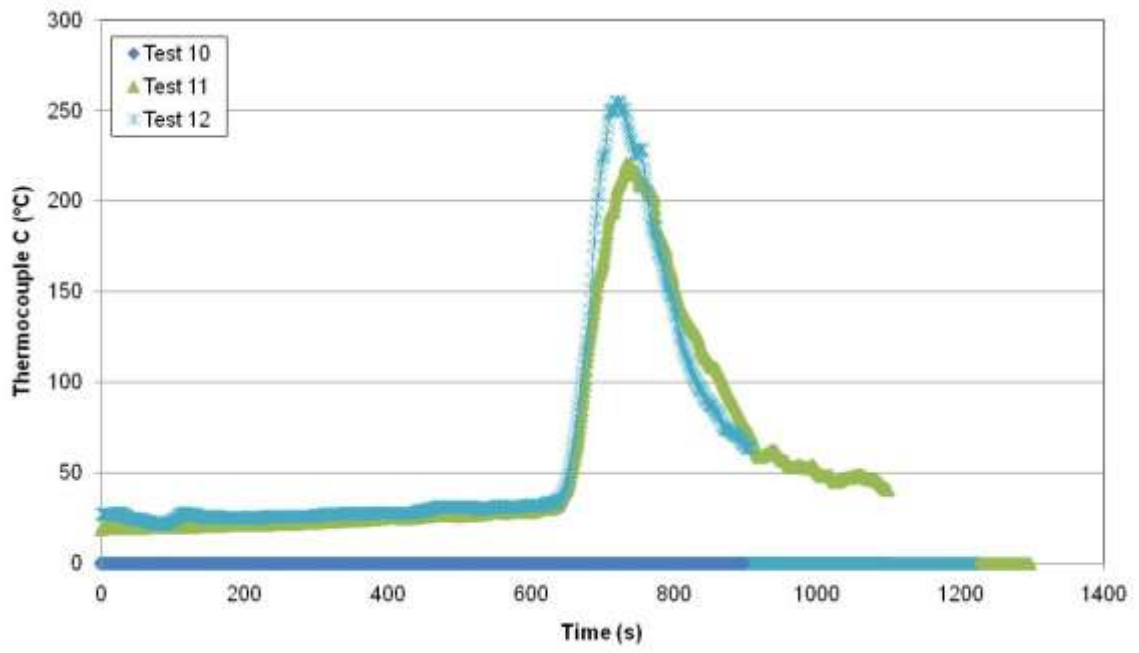

(c)

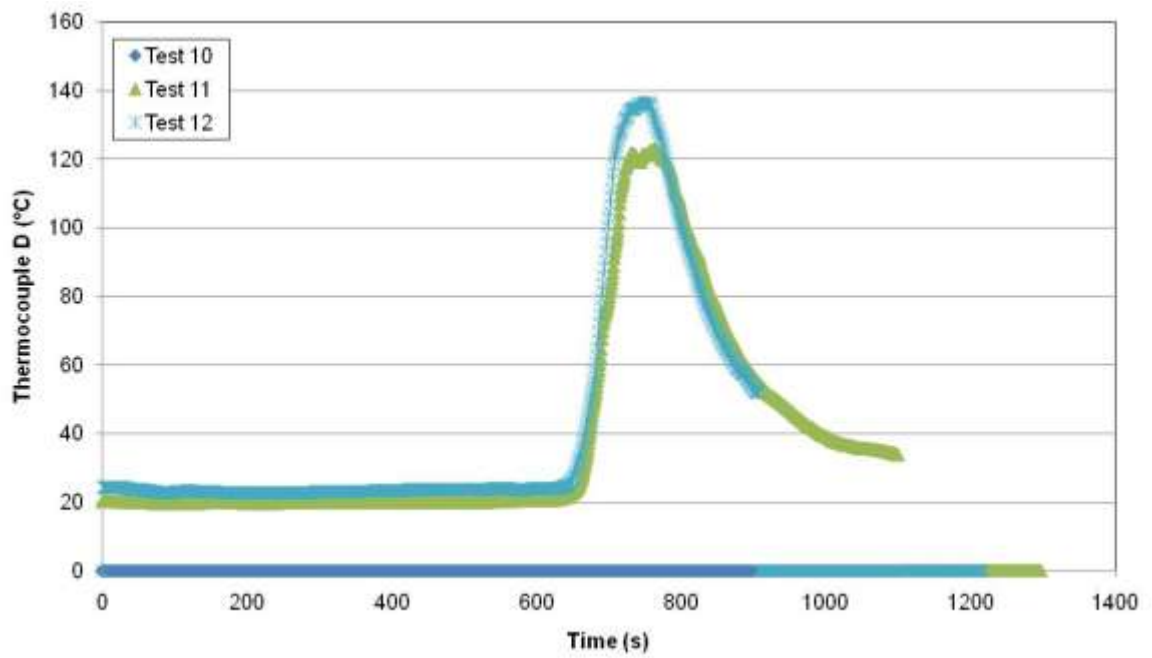

(d)

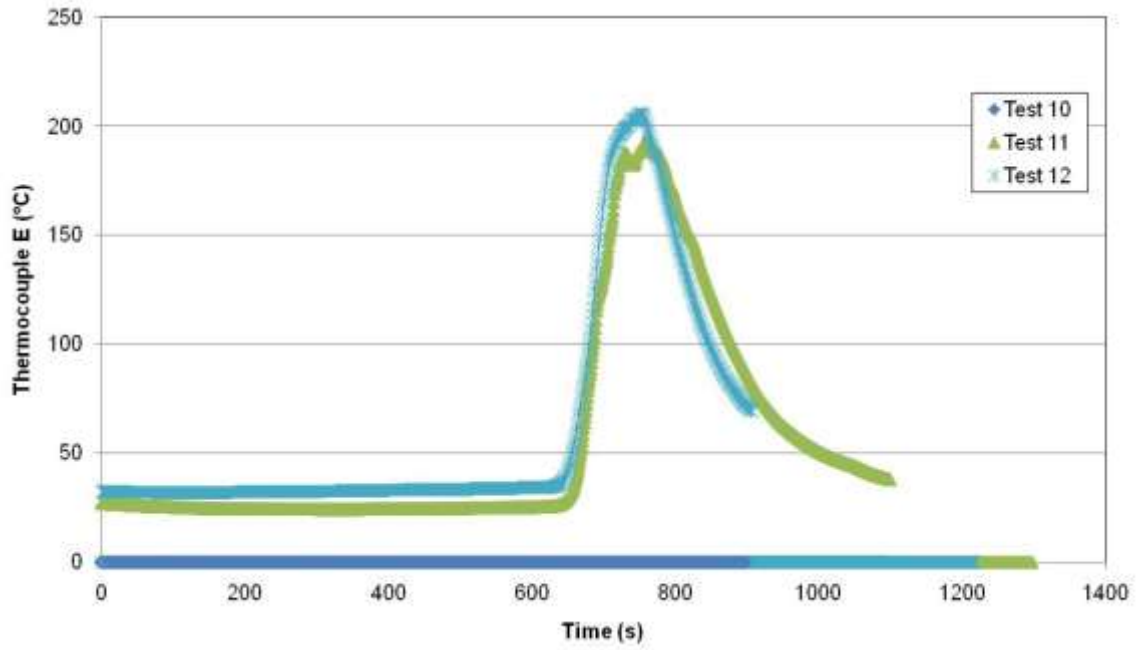

(e)

Figure 22: Thermocouple measurements of (a) thermocouple A, (b) thermocouple B, (c) thermocouple C, (d) thermocouple D, and (e) thermocouple E for Tests 11 and 12.

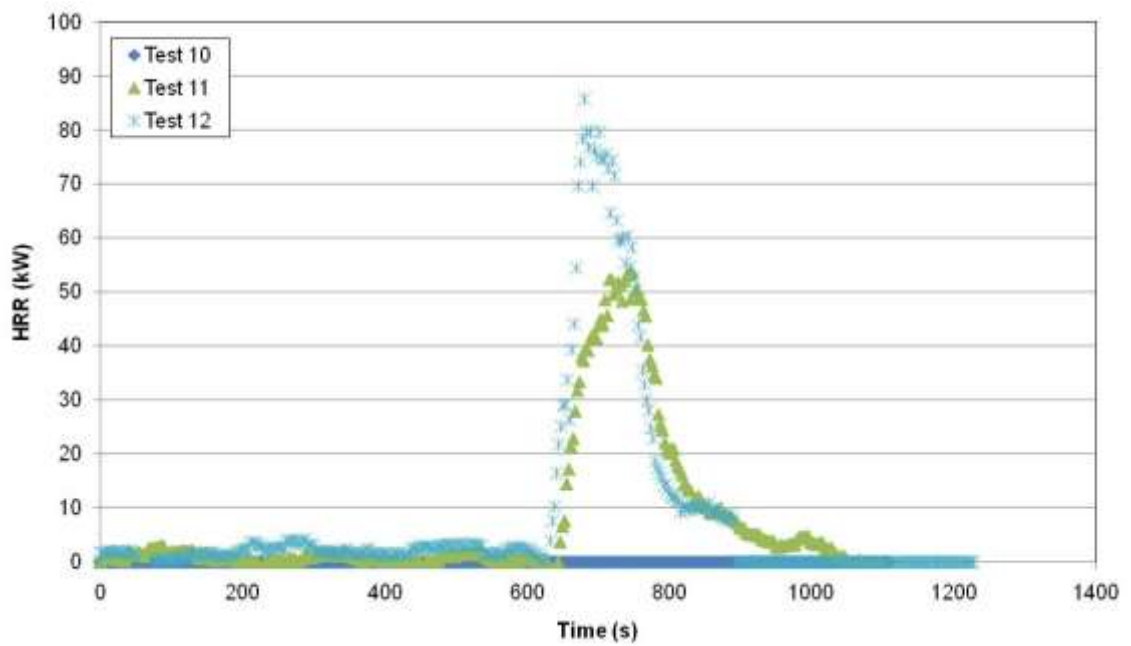
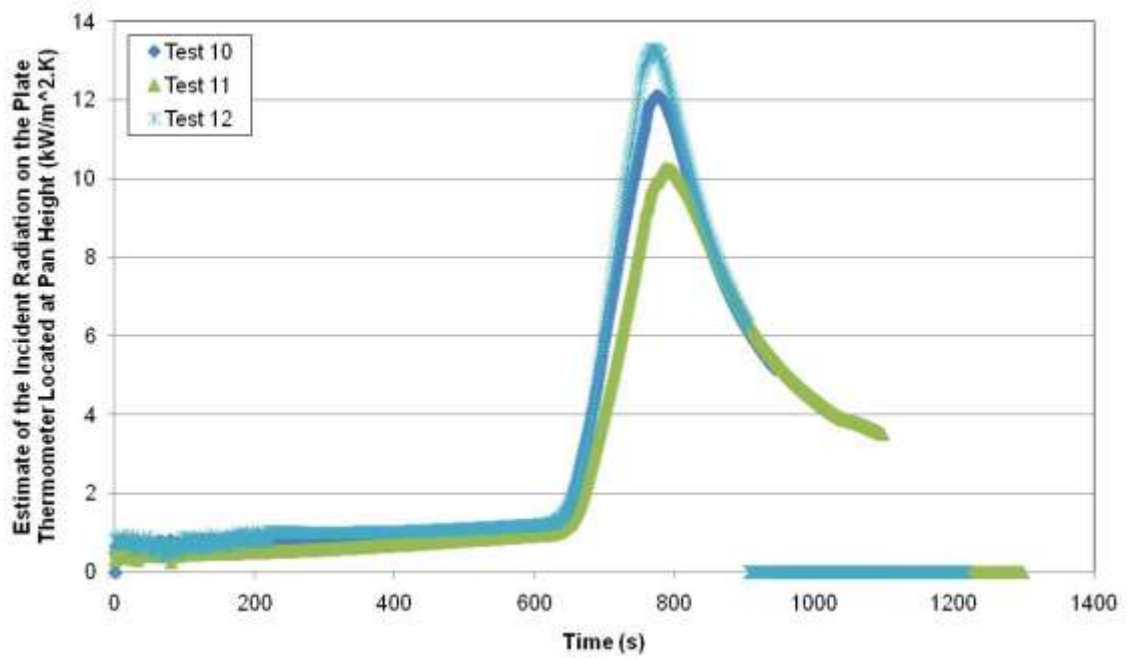
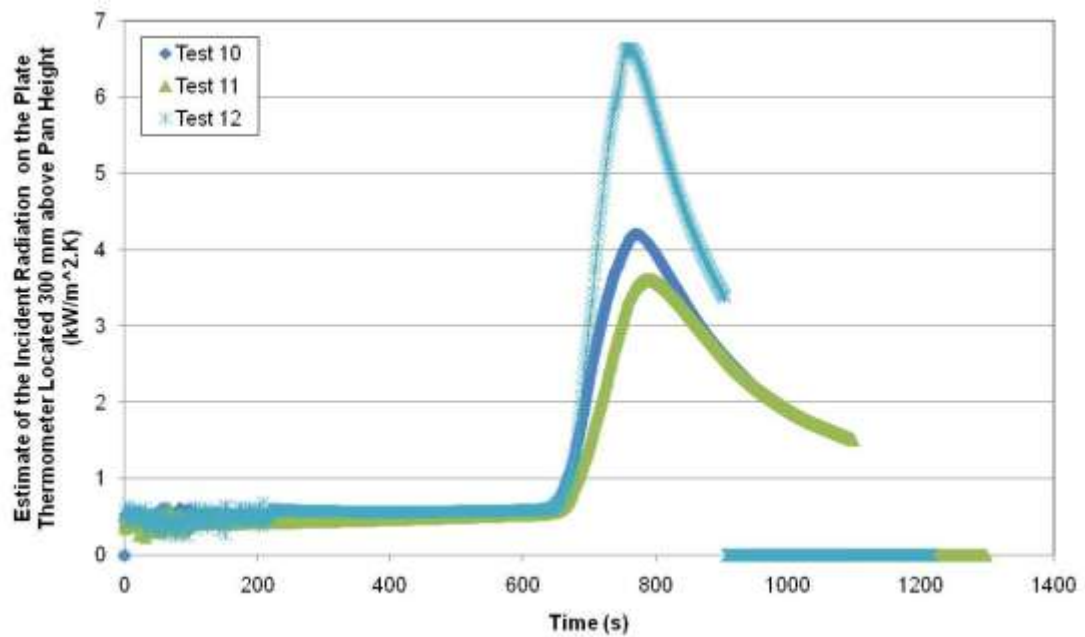

Figure 23: Heat release rates estimated from oxygen calorimetry for Tests 11 and 12.

4.4.1 Analysis



(a)



(b)

Figure 24: Estimates of the incident radiation on the plate thermometer (a) at the height of the lip of the skillet, and (b) 300 mm above the lip of the skillet.

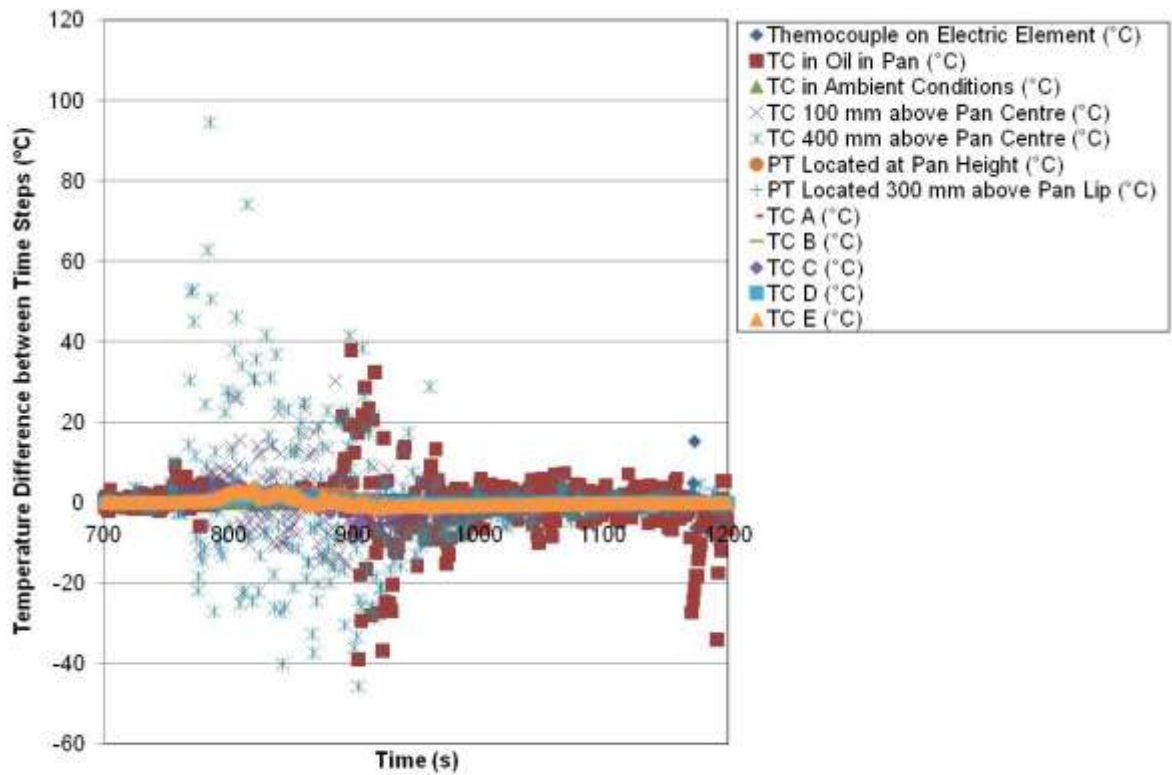

Figure 25: Examples of the differences of each of the variable temperatures to between sequential time steps for Test 11.

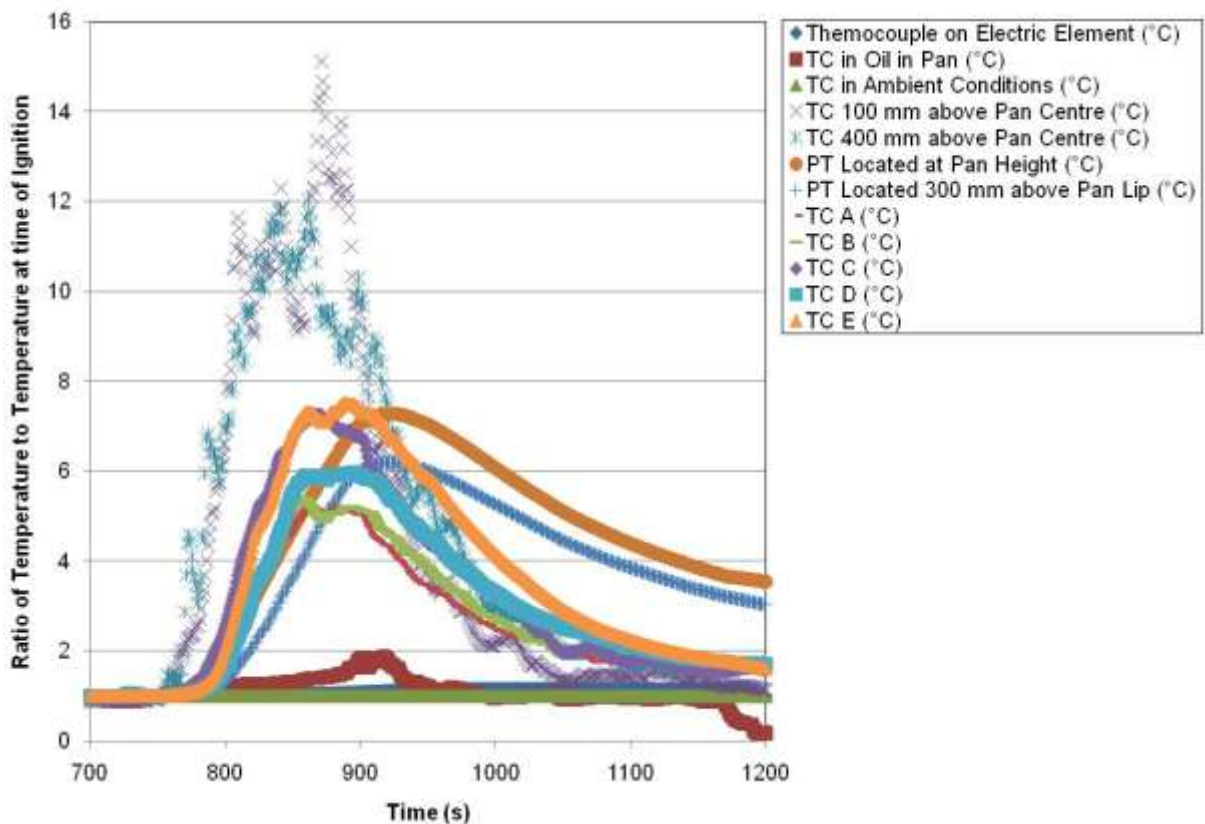
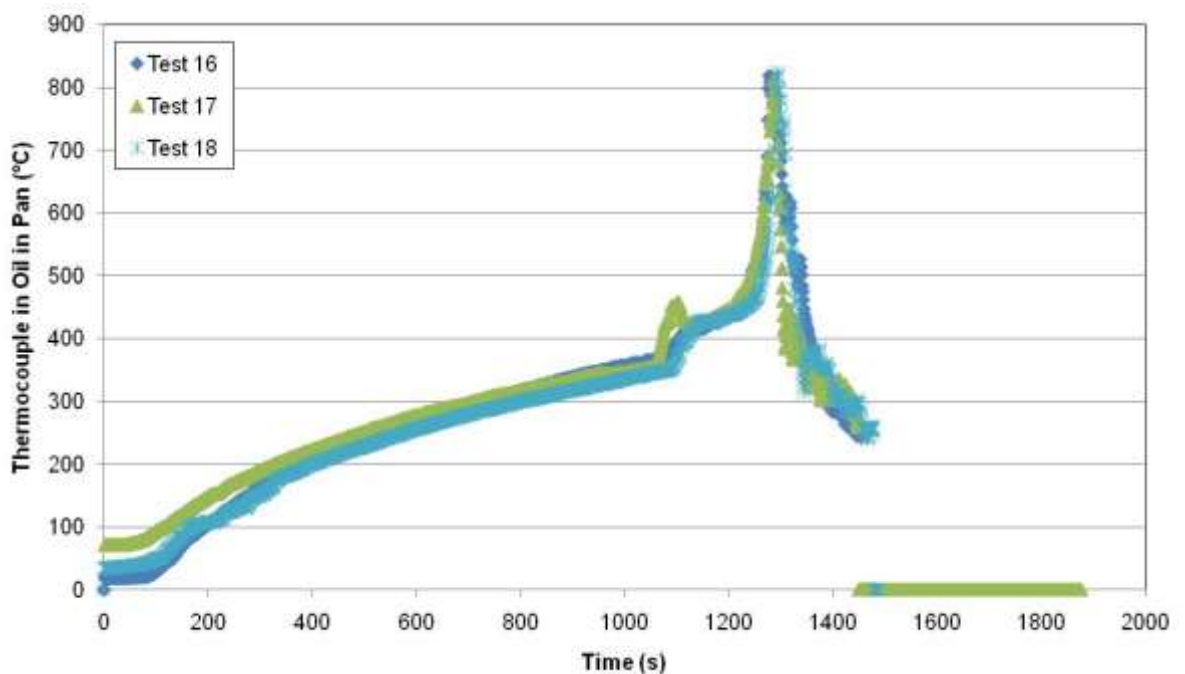

Figure 26: Examples of the ratios of each of the variable temperatures to the temperatures at the time of ignition for Test 11.

4.5 Skillet with 400 ml Canola Oil, Fan (Tests 16 – 18)

This test was a free-standing electric stove-top under the furniture calorimeter hood with the fan turned on (also allowing data to be collected for the heat release rate). The skillet, with 400 ml of canola oil, was present on the powered electric element. This test formed a comparison with the results where 200 ml canola oil was used (e.g. Section 4.3). Tests 16 to 18 are examples of this scenario. The thermocouple measurements in the oil and above the centre of the pan are shown in Figure 27. Plate thermometer temperature measurements are shown in Figure 28. Thermocouple measurements from the locations on the surface of the stove-top are shown in Figure 29. Heat release rates based on oxygen calorimetry are shown in Figure 30. Estimates of the incident radiation on the plate thermometers are shown in Figure 31. An example of the temperature differences between sequential time steps for each of the variables recorded is shown in Figure 32 for Test 17 (where the time shown is based on the original test data, as included in Appendices C and D). An example of the ratios of temperatures to the temperature at the time of ignition for each of the variables recorded is shown in Figure 33 for Test 17 (where the time shown is based on the original test data, as included in Appendices C and D).



(a)

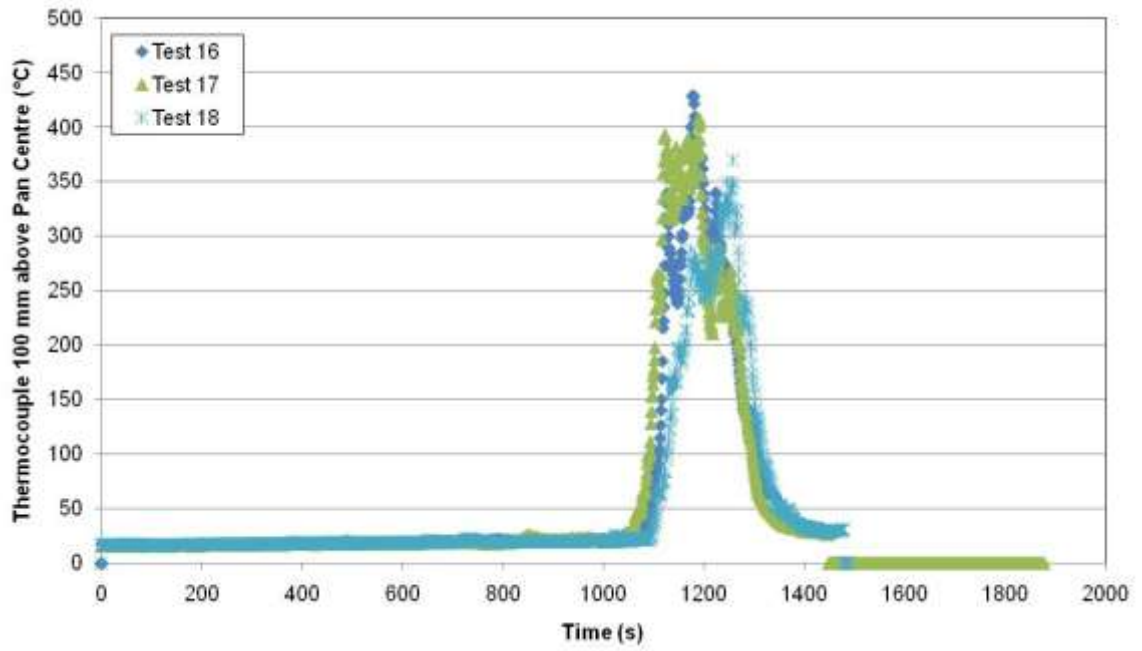

(b)

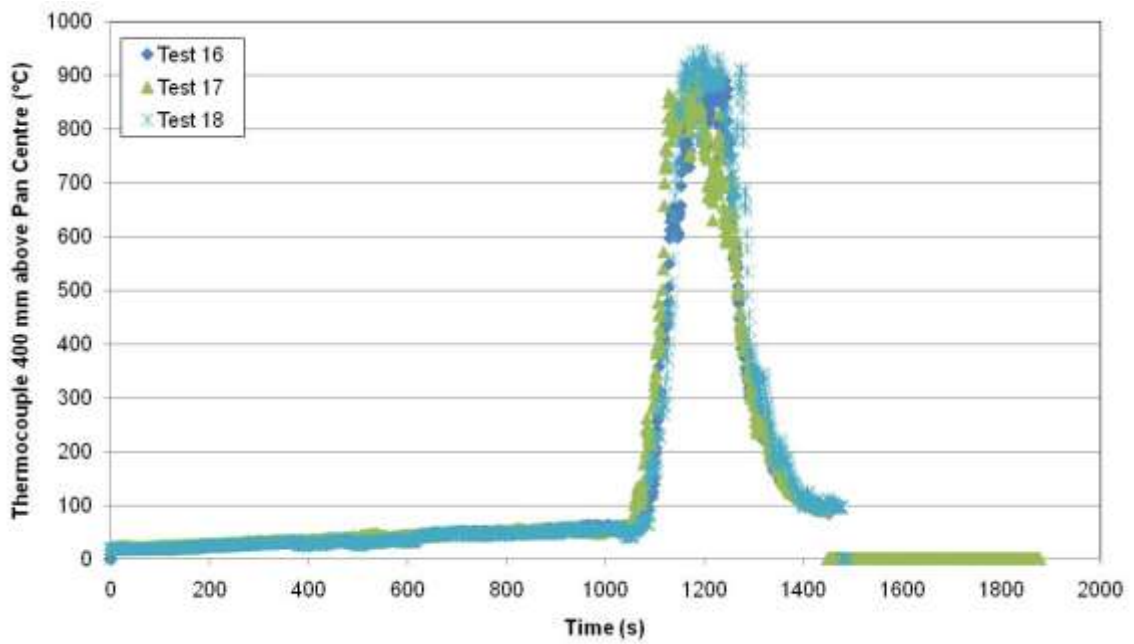

(c)

Figure 27: Thermocouple measurements for the thermocouple located (a) in the oil in the skillet, (b) 100 mm above the centre of the skillet, and (c) 400 mm above the centre of the skillet for Tests 16 – 18.

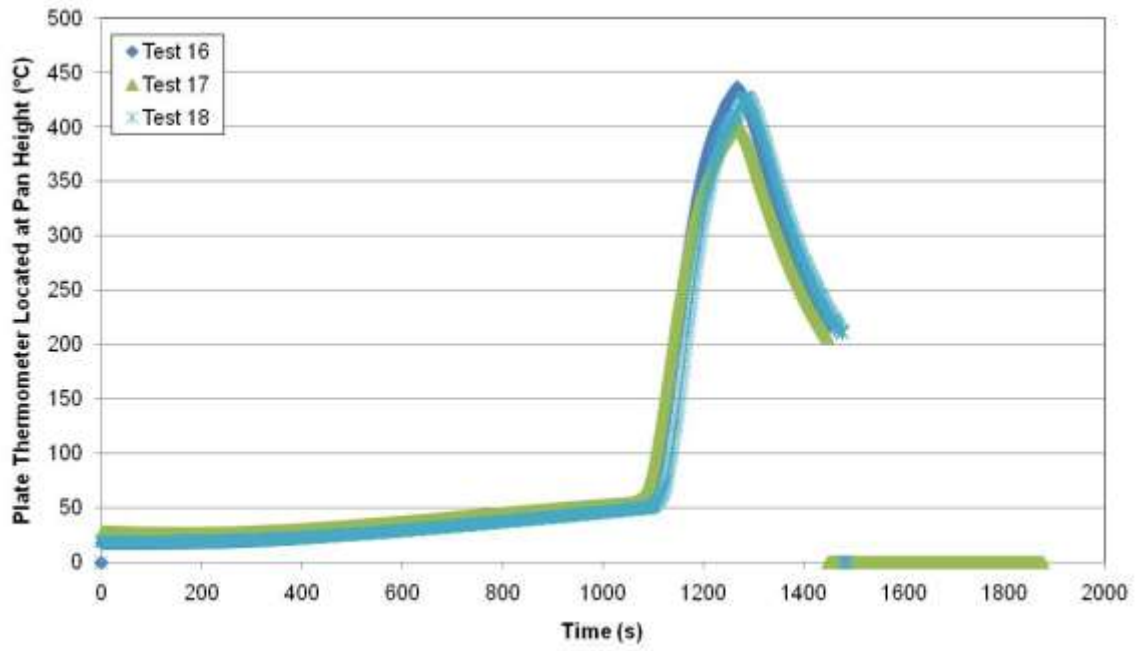

(a)

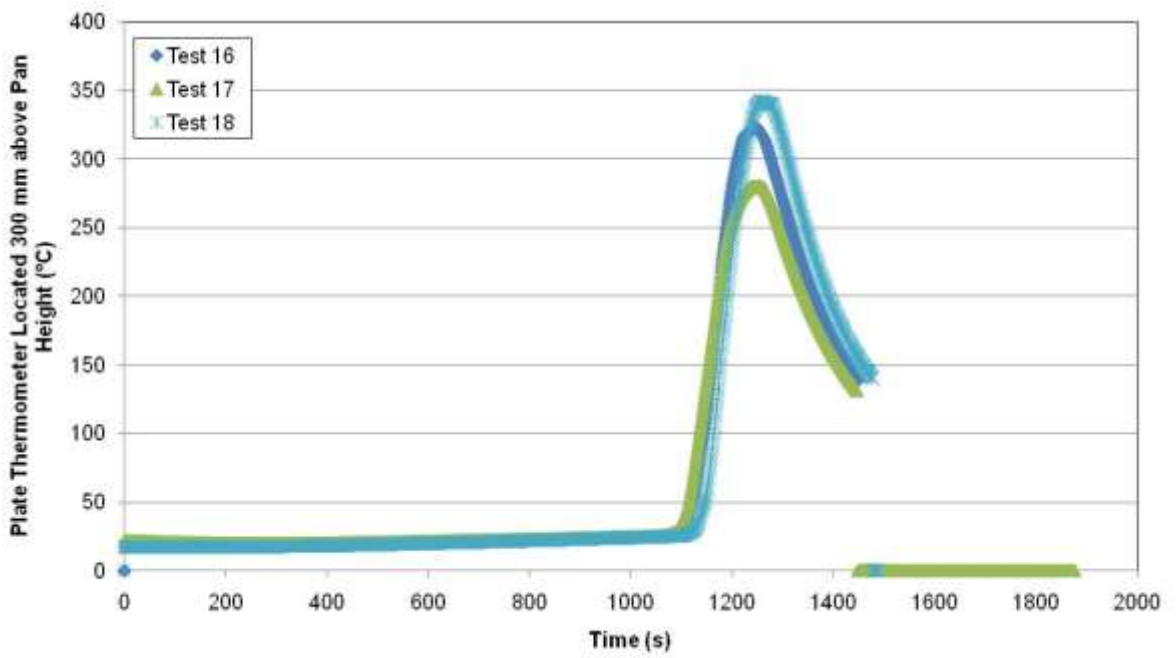

(b)

Figure 28: Plate thermometer temperature measurements for (a) at the height of the lip of the skillet, and (b) 300 mm above the lip of the skillet for Tests 16 – 18.

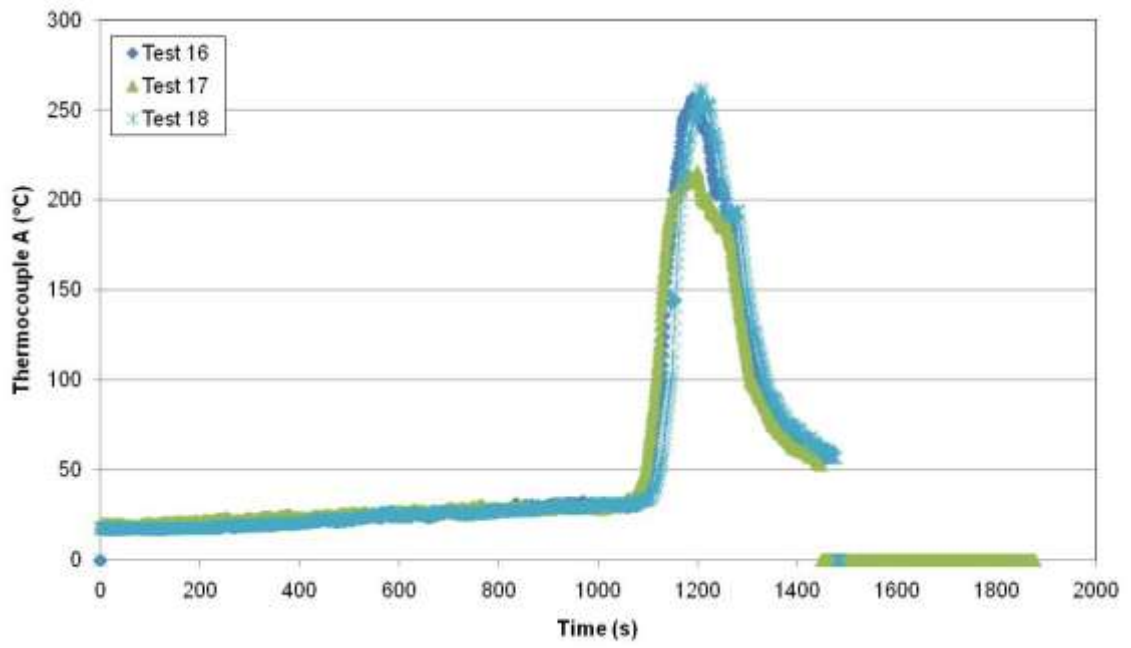

(a)

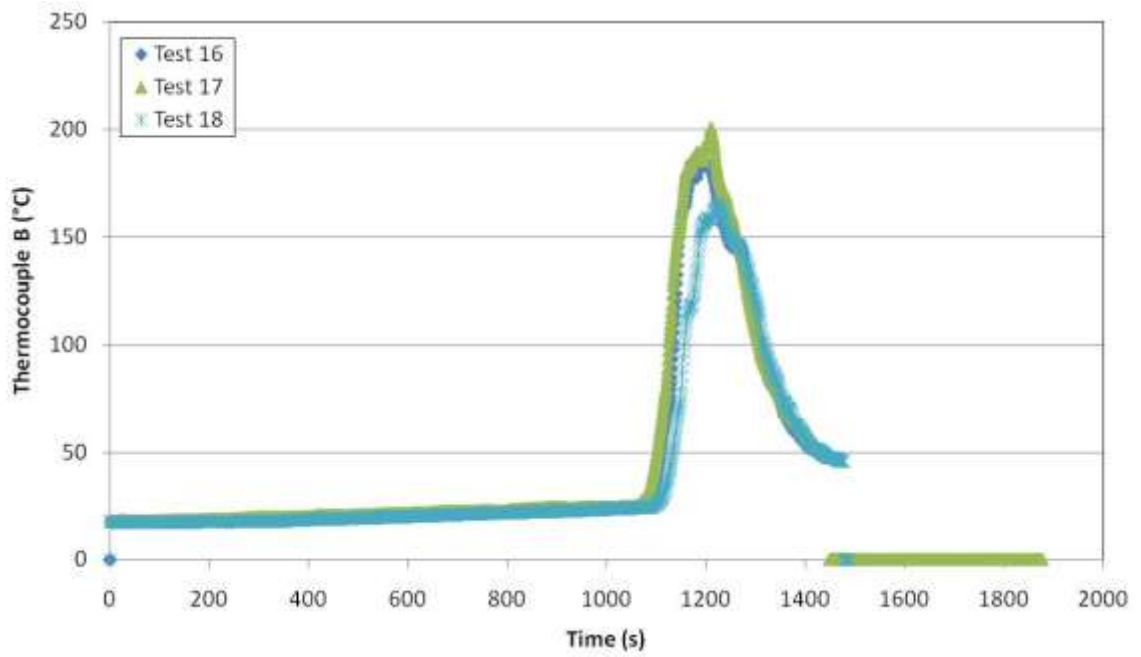

(b)

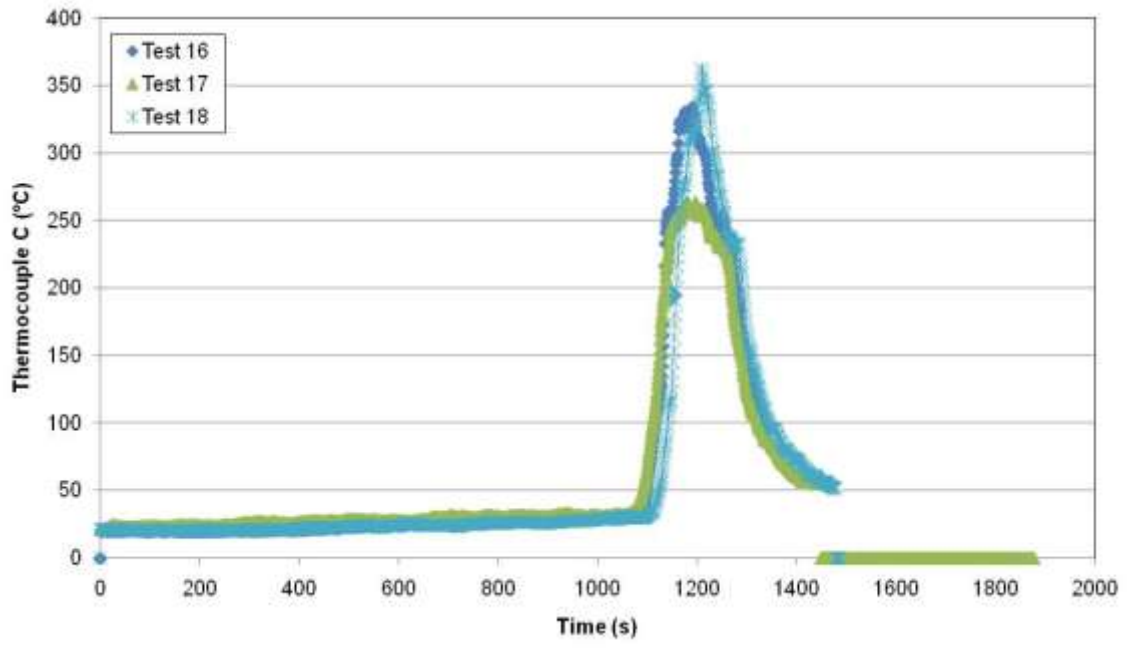

(c)

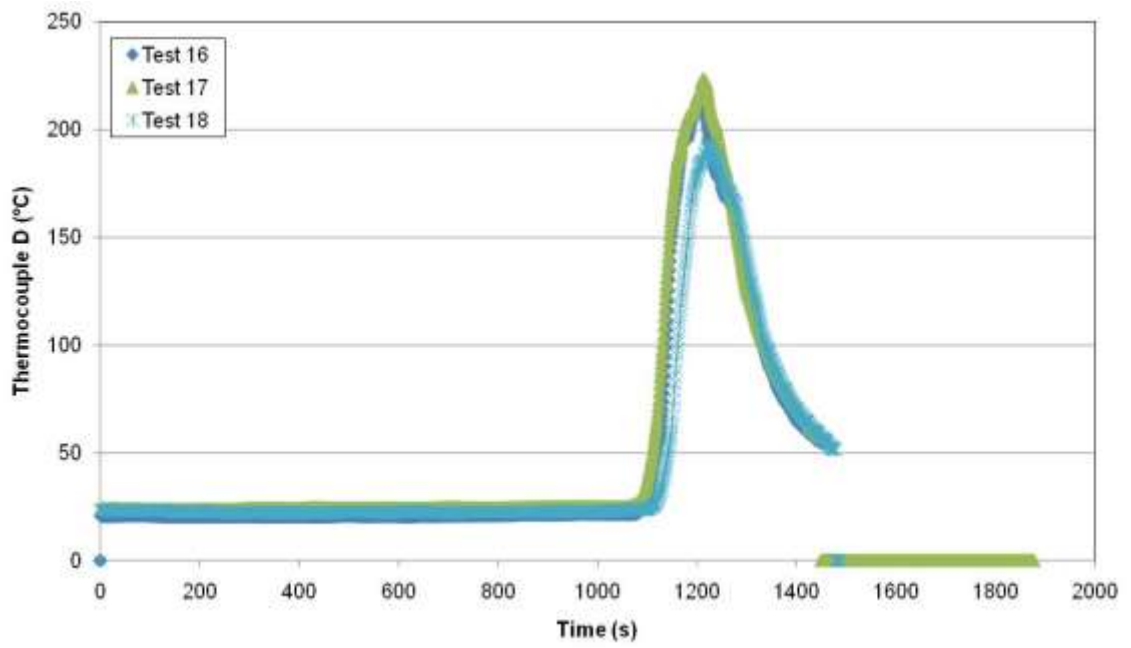

(d)

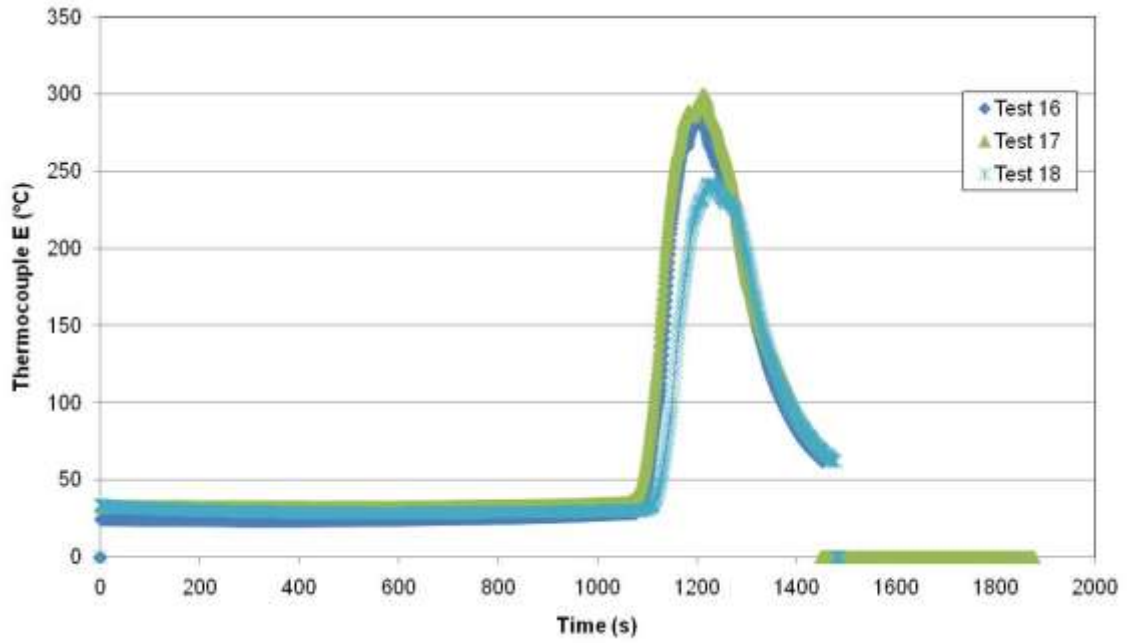

(e)

Figure 29: Thermocouple measurements of (a) thermocouple A, (b) thermocouple B, (c) thermocouple C, (d) thermocouple D, and (e) thermocouple E for Tests 16 – 18.

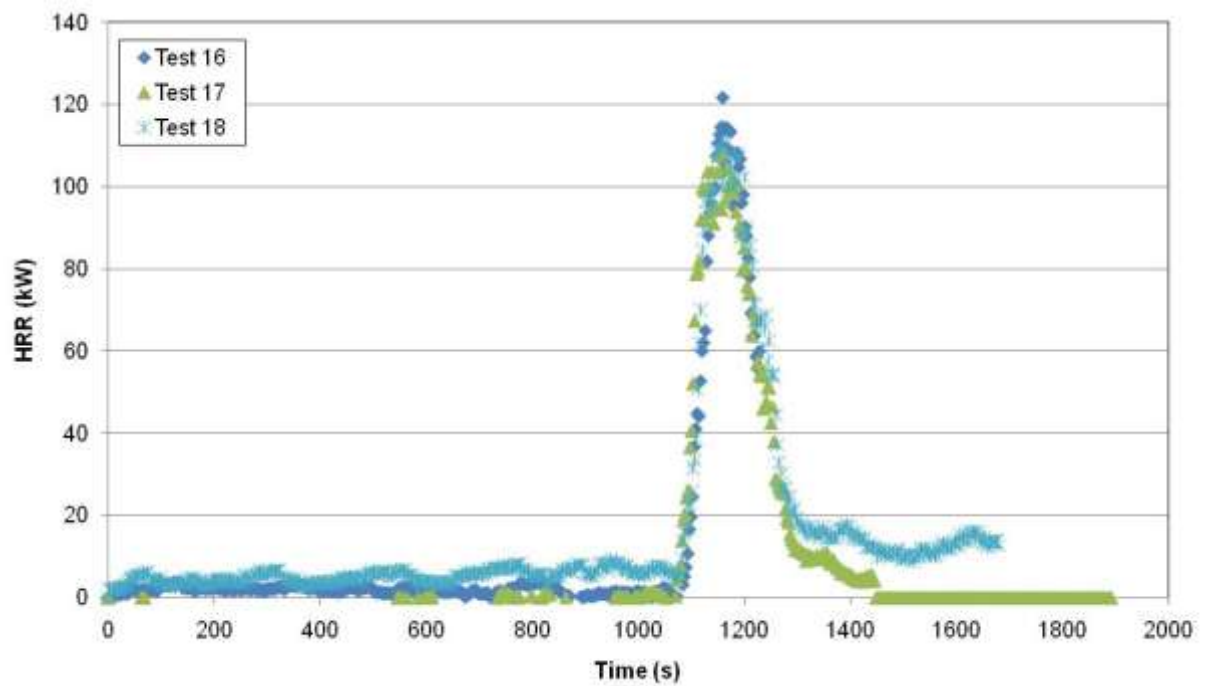
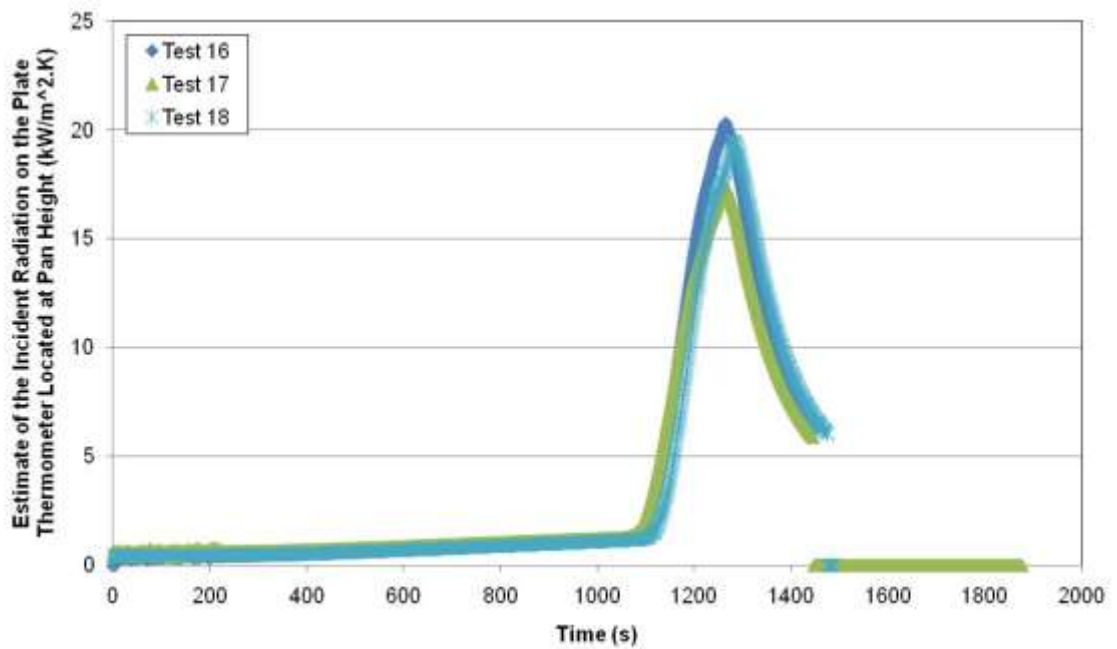
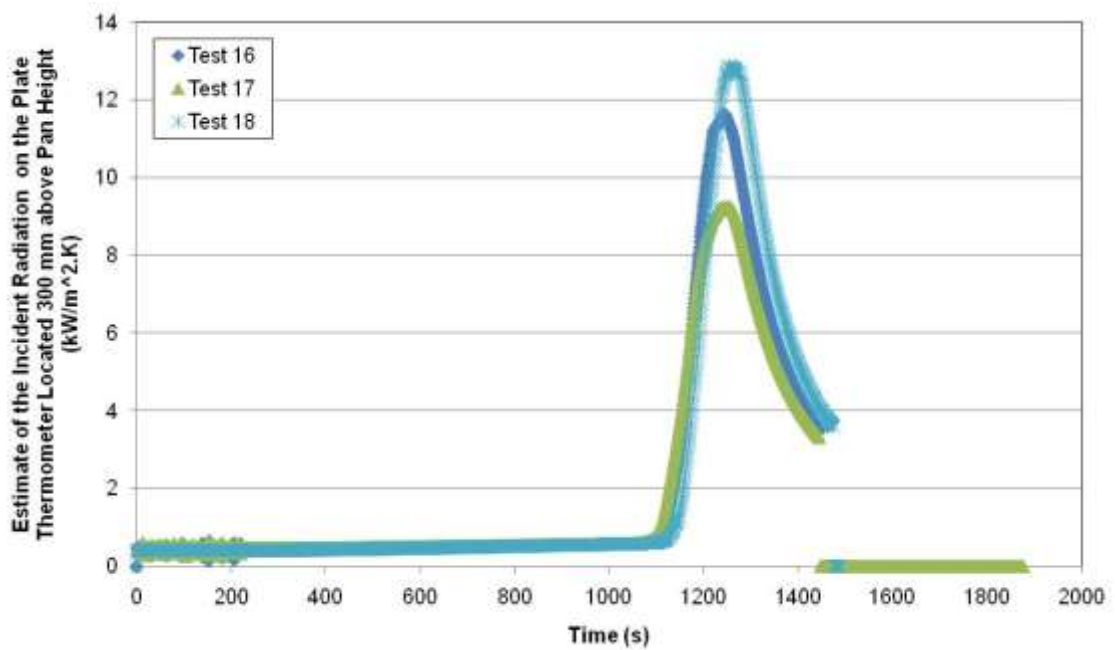

Figure 30: Heat release rates estimated from oxygen calorimetry for Tests 16 – 18.

4.5.1 Analysis



(a)



(b)

Figure 31: Estimates of the incident radiation on the plate thermometer (a) at the height of the lip of the skillet, and (b) 300 mm above the lip of the skillet for Tests 16 – 18.

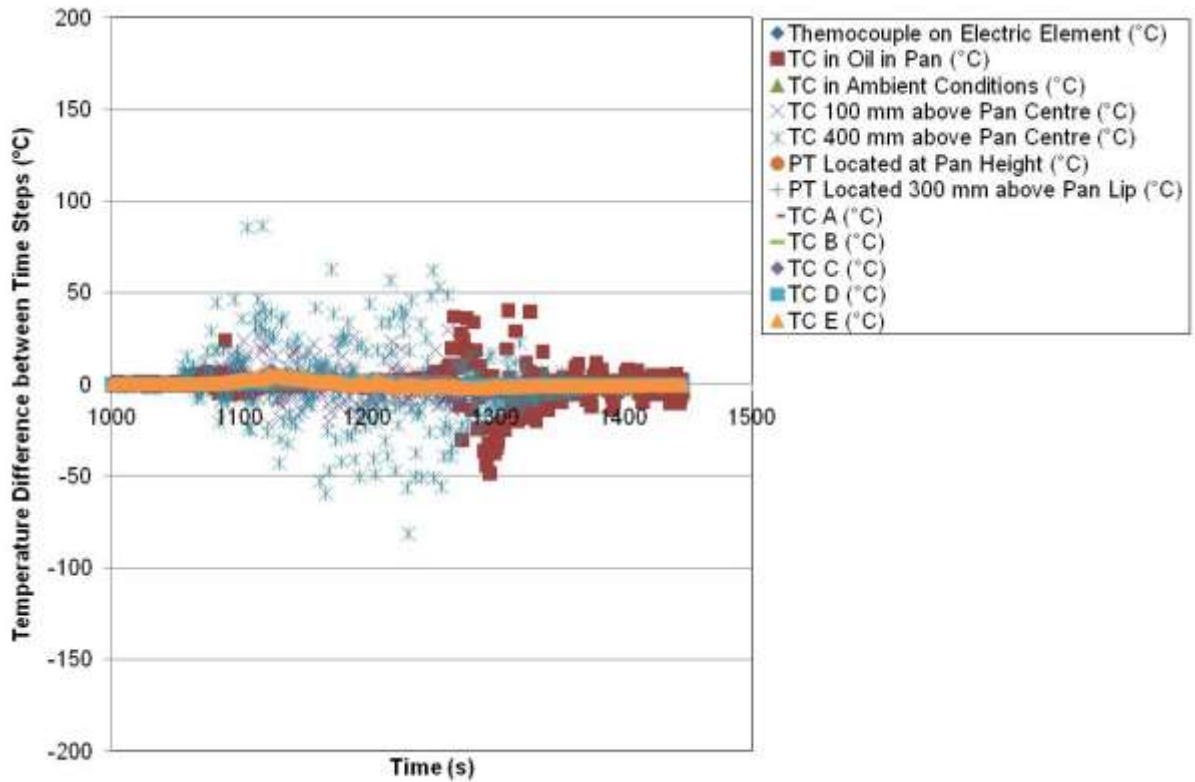

Figure 32: Examples of differences of each of the variable temperatures to between sequential time steps for Test 17.

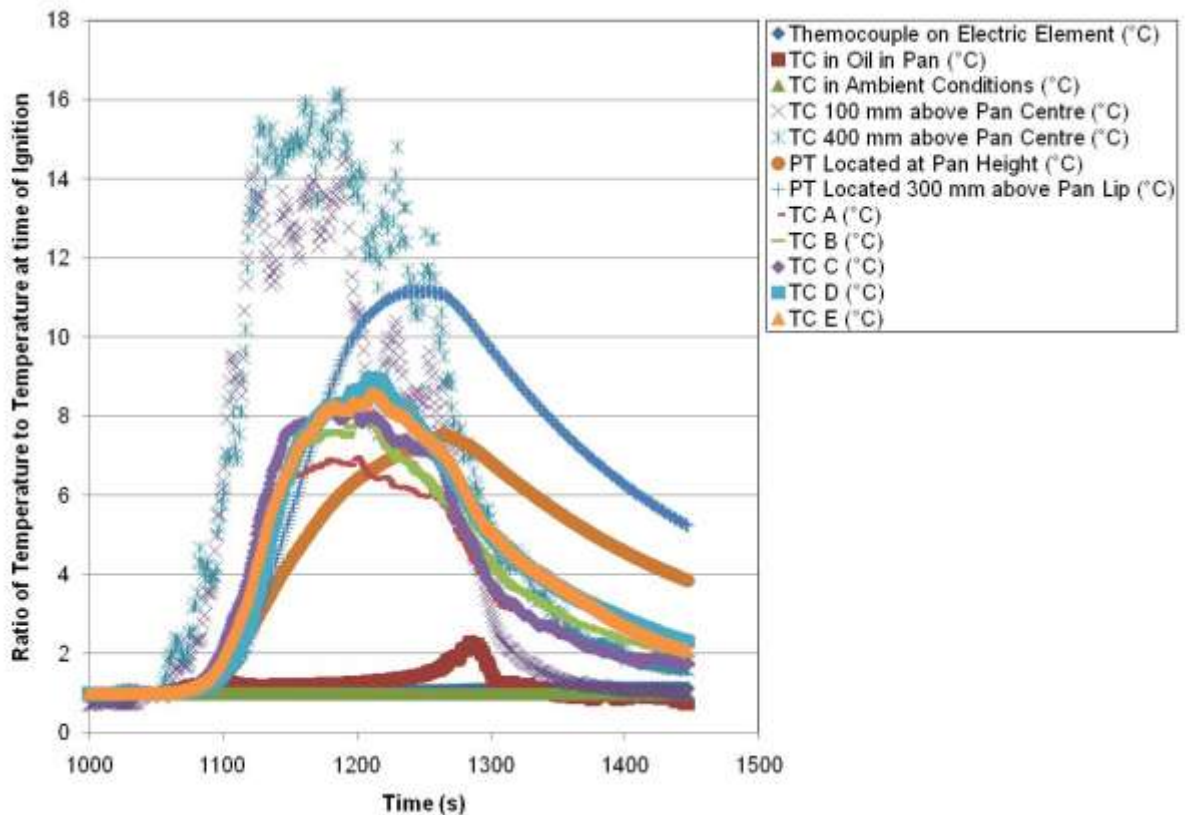
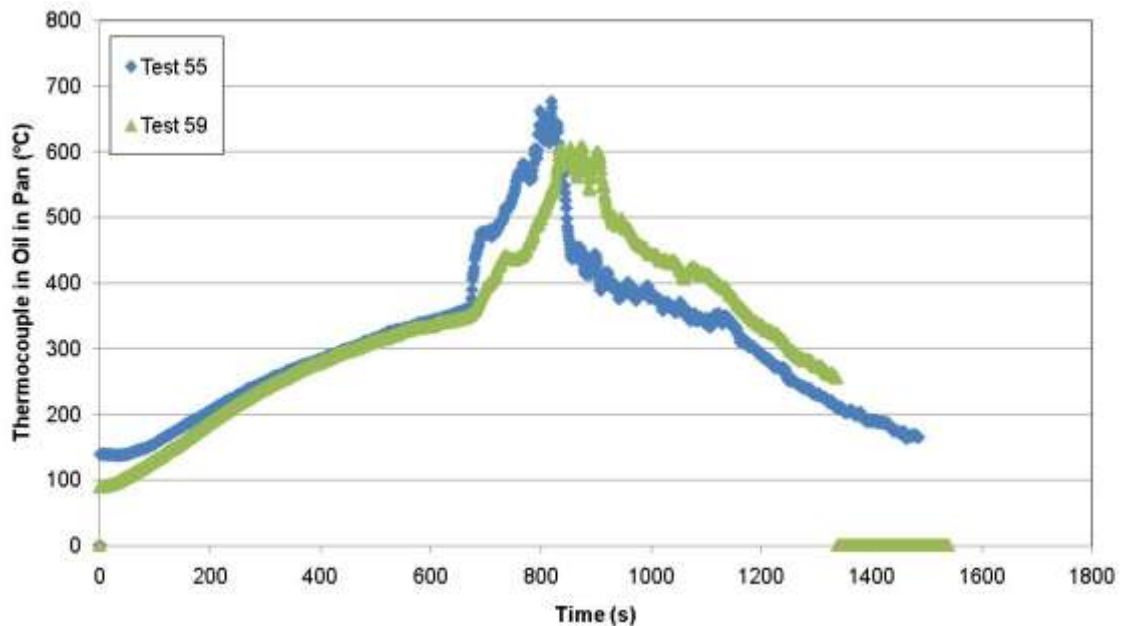

Figure 33: Examples of ratios of each of the variable temperatures to the temperatures at the time of ignition for Test 17.

4.6 Skillet with 200 ml Canola Oil, Fan, Corridor (Tests 55 & 59)

This test was an electric stove-top against a wall in the partial corridor under the furniture calorimeter hood with the fan turned on (also allowing data to be collected for the heat release rate). The skillet, with 200 ml of canola oil, was present on the powered electric element. This test formed a comparison to the results for the setup with a free-standing stove-top and flaming 200 ml canola oil with the extraction fan running (e.g. Section 4.3). Tests 55 and 59 are examples of this scenario. The thermocouple measurements in the oil and above the centre of the pan are shown in Figure 34. Plate thermometer temperature measurements are shown in Figure 35. Thermocouple measurements for locations on the surface of the stove-top are shown in Figure 36. Thermocouple measurements for locations on the ceiling of the partial corridor are shown in Figure 37. Heat release rates based on oxygen calorimetry are shown in Figure 38. Estimates of the incident radiation on the plate thermometers are shown in Figure 39. An example of the temperature differences between sequential time steps for each of the variables recorded is shown in Figure 40 for Test 55 (where the time shown is based on the original test data, as included in Appendices C and D). An example of the ratios of temperatures to the temperature at the time of ignition for each of the variables recorded is shown in Figure 41 for Test 55 (where the time shown is based on the original test data, as included in Appendices C and D).



(a)

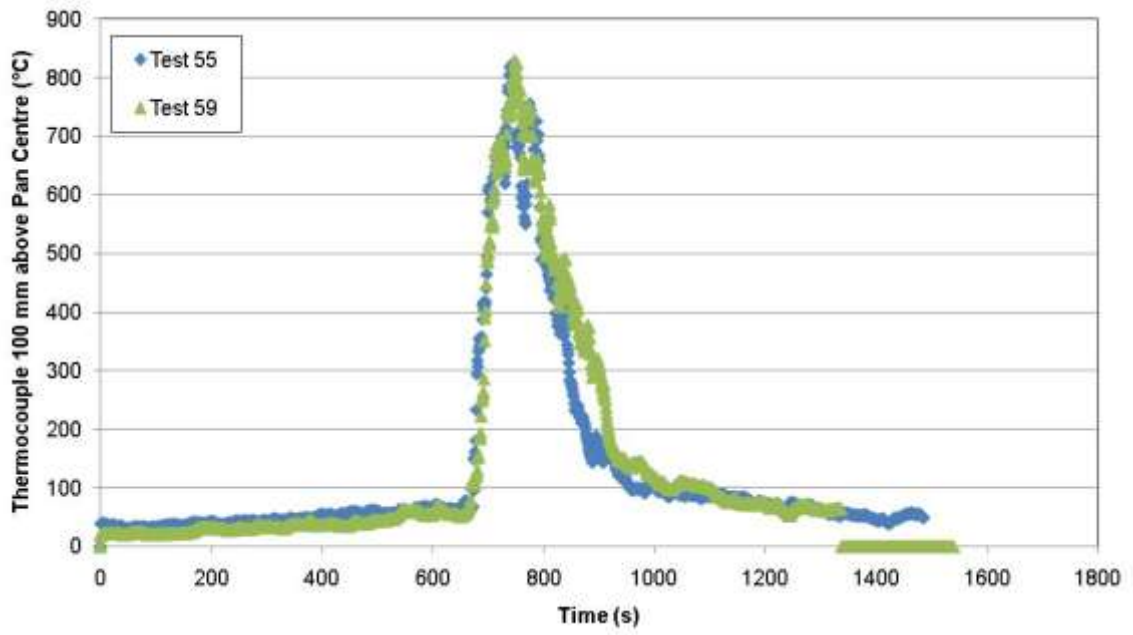

(b)

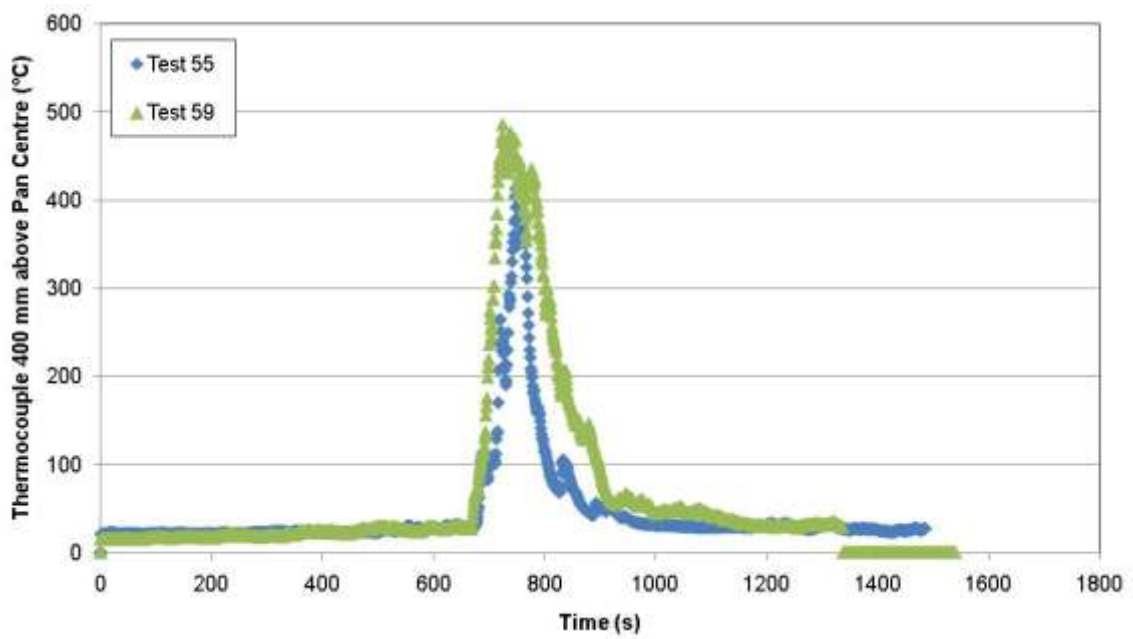

(c)

Figure 34: Thermocouple measurements for the thermocouple located (a) in the oil in the skillet, (b) 100 mm above the centre of the skillet, and (c) 400 mm above the centre of the skillet for Tests 55 and 59.

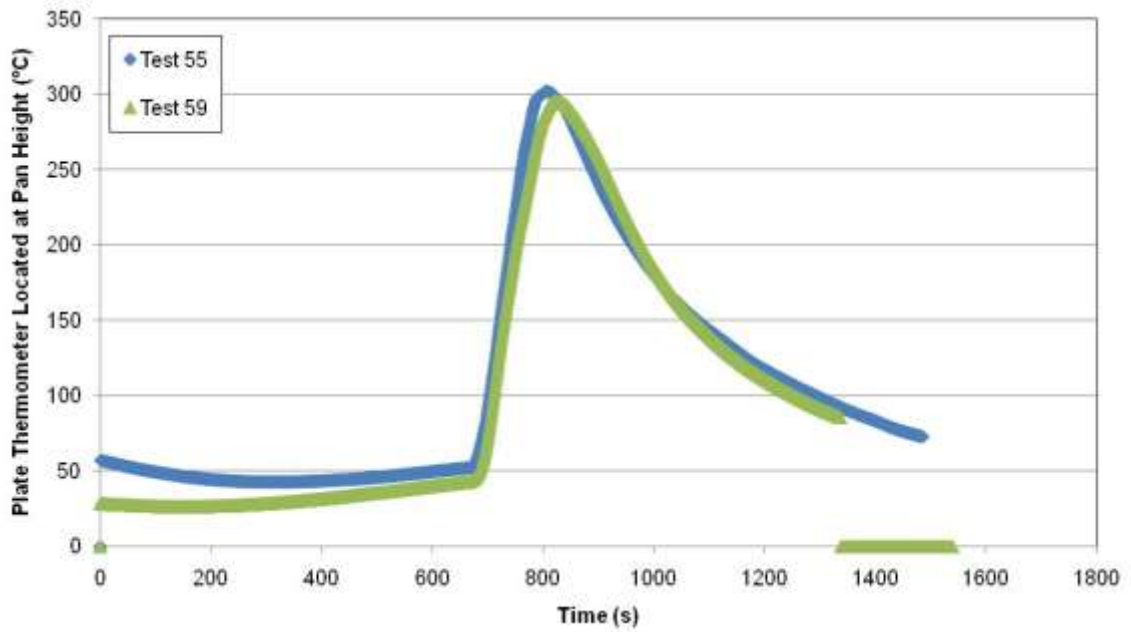

(a)

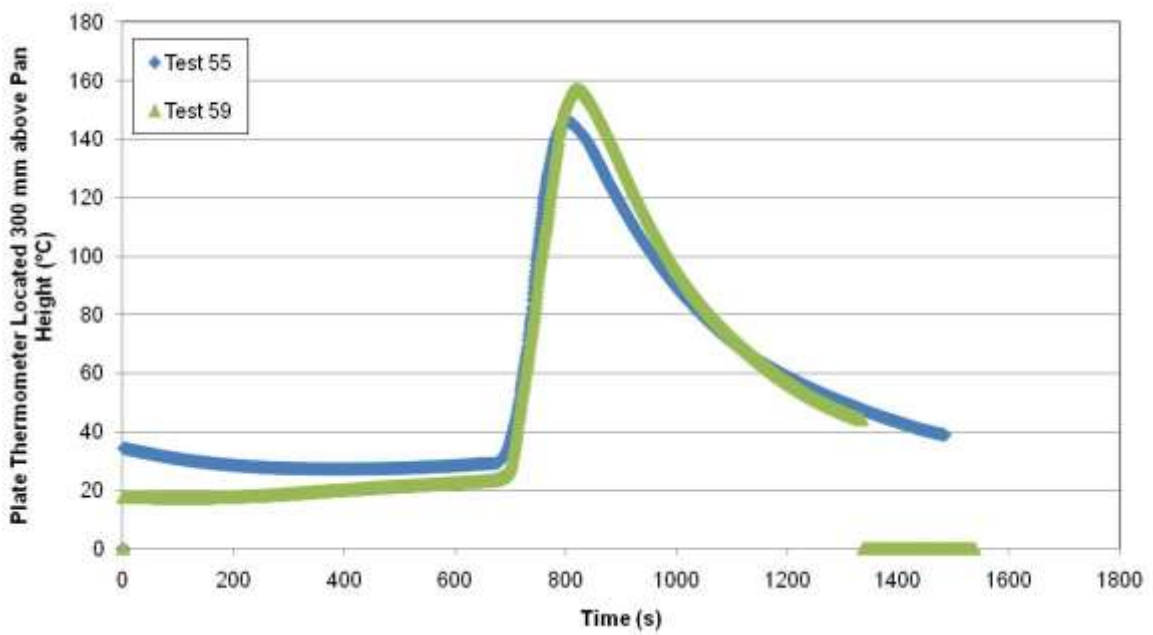

(b)

Figure 35: Plate thermometer temperature measurements for (a) at the height of the lip of the skillet, and (b) 300 mm above the lip of the skillet for Tests 55 and 59.

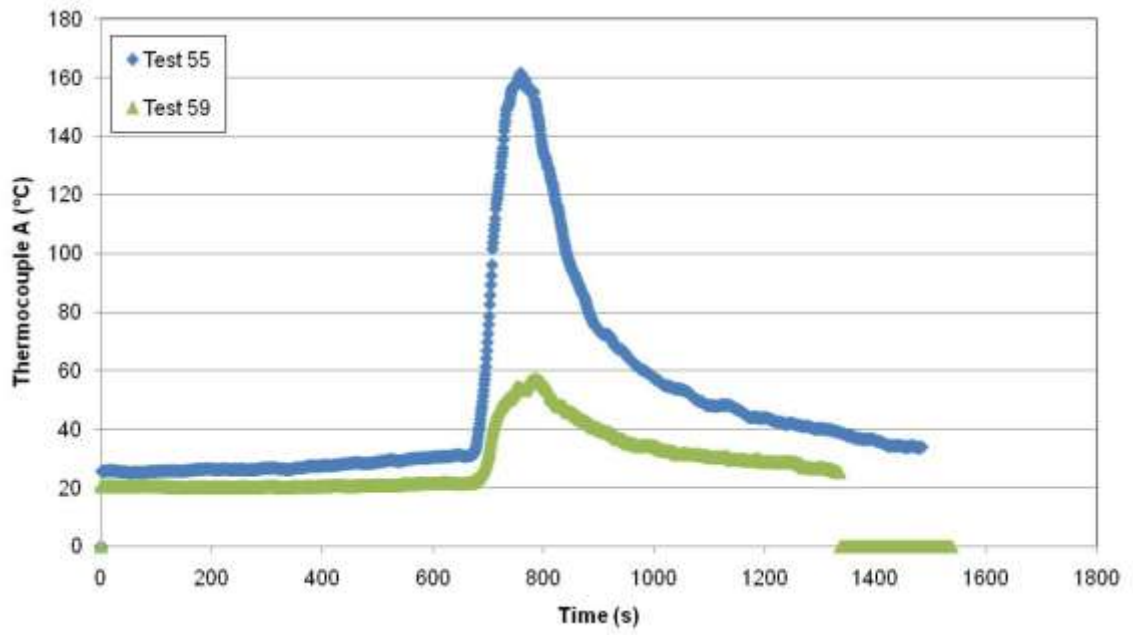

(a)

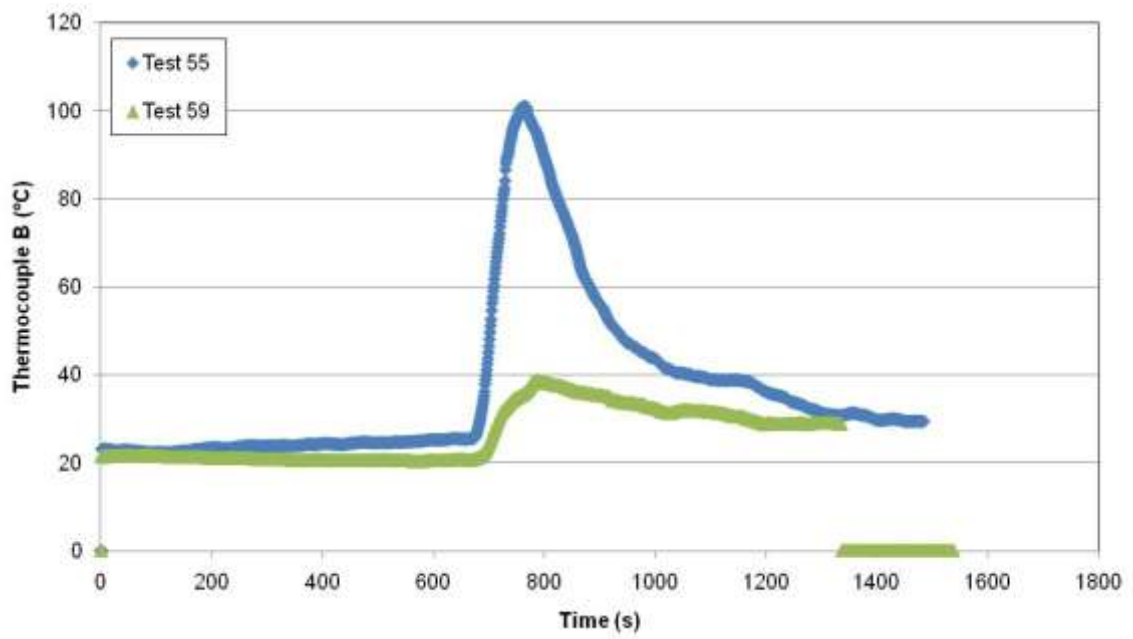

(b)

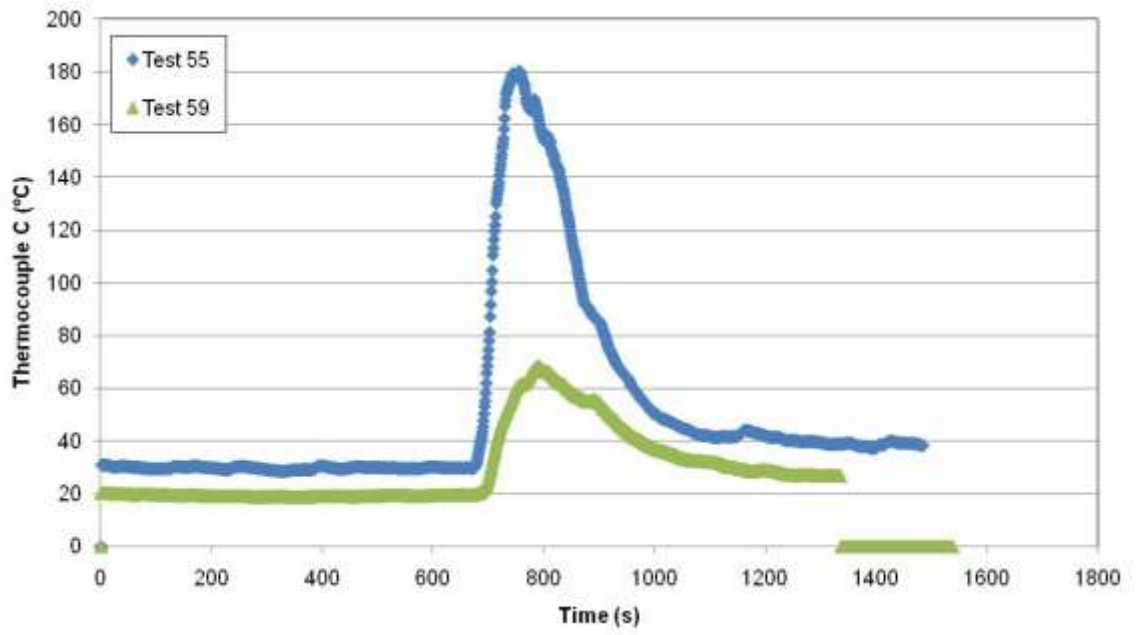

(c)

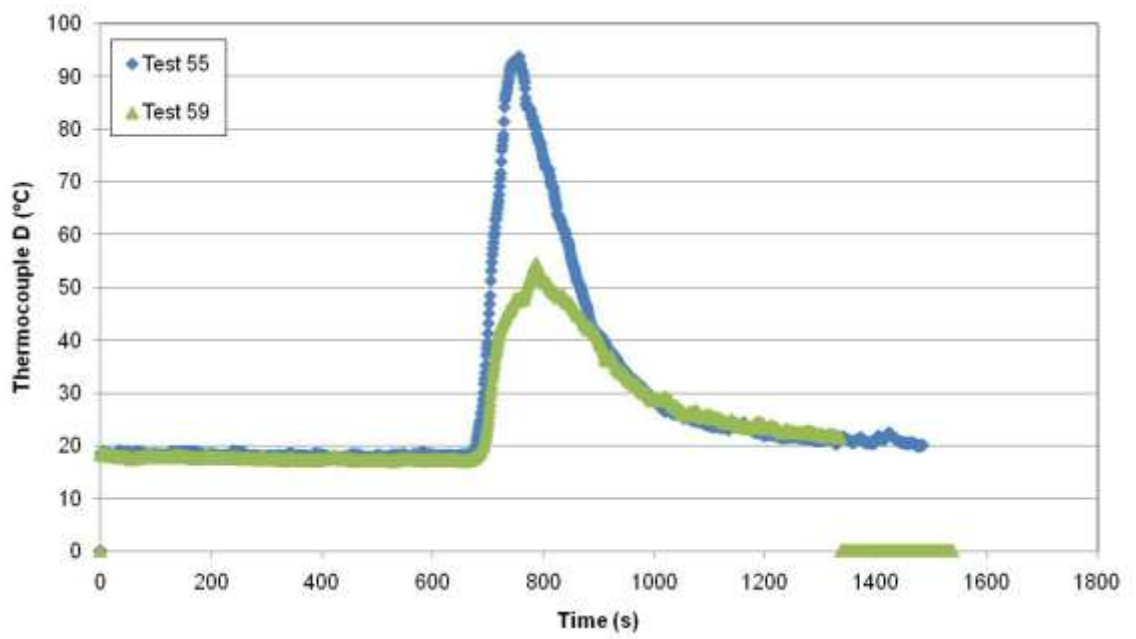

(d)

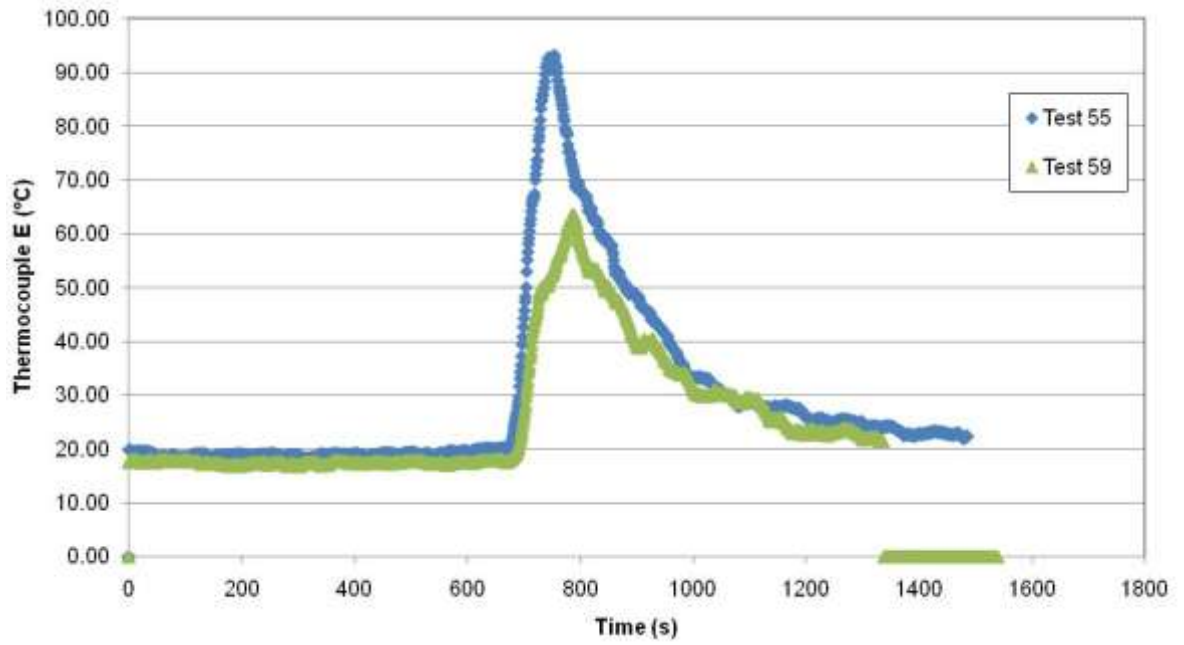

(e)

Figure 36: Thermocouple measurements of (a) thermocouple A, (b) thermocouple B, (c) thermocouple C, (d) thermocouple D, and (e) thermocouple E for Tests 55 and 59.

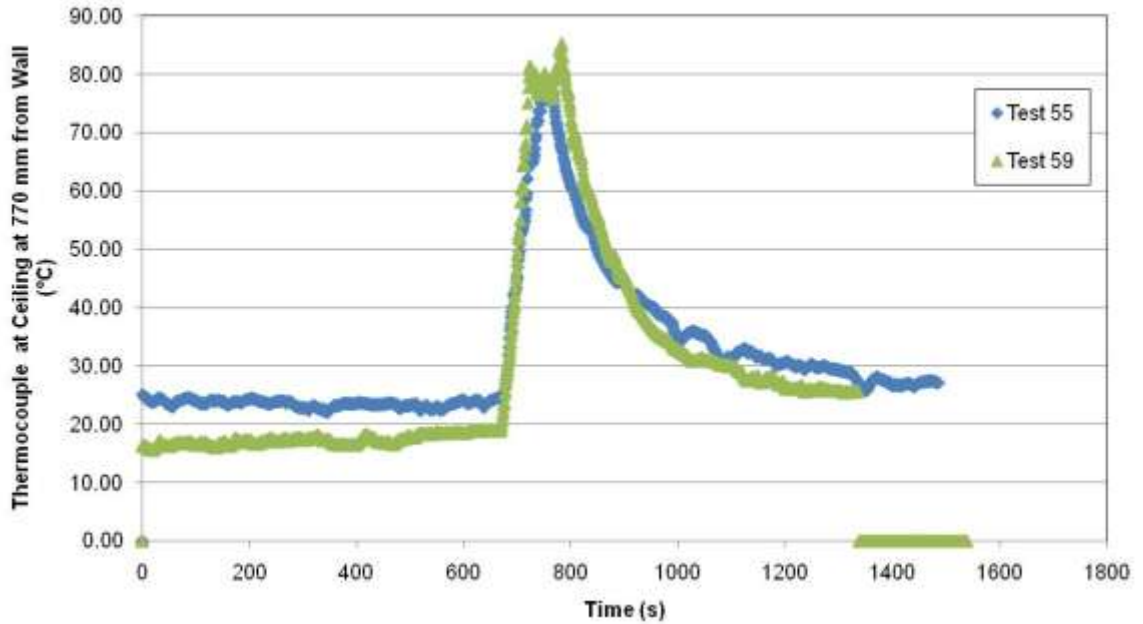

(a)

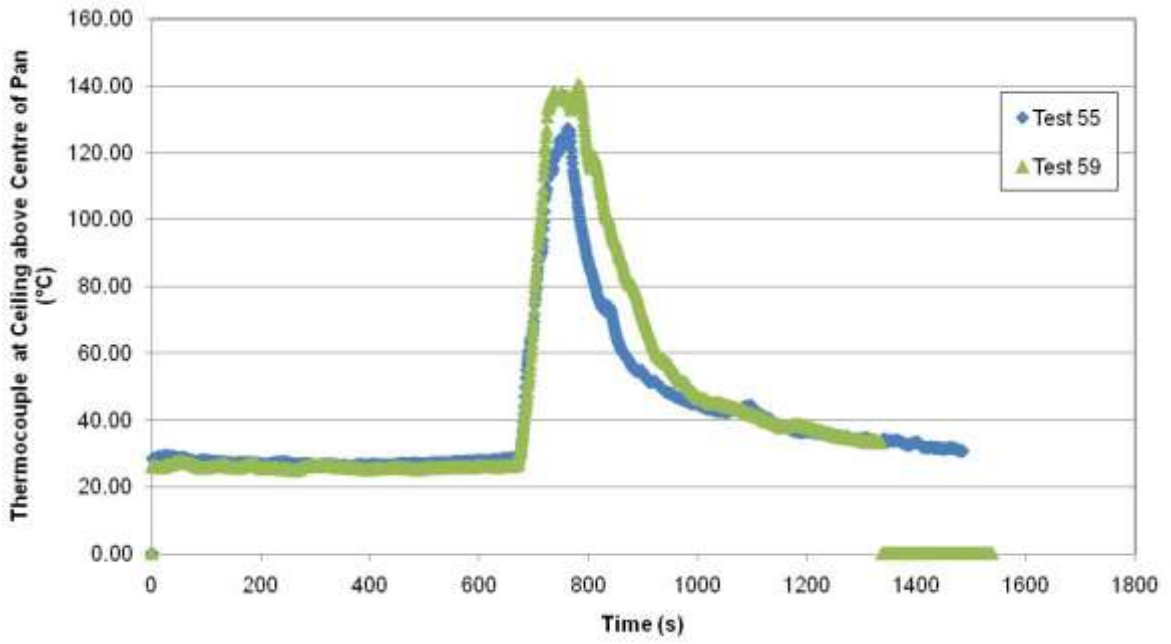

(b)

Figure 37: Thermocouple measurements at the ceiling (a) 770 mm from the wall and centred in the corridor, and (b) directly above the centre of the skillet for Tests 55 and 59.

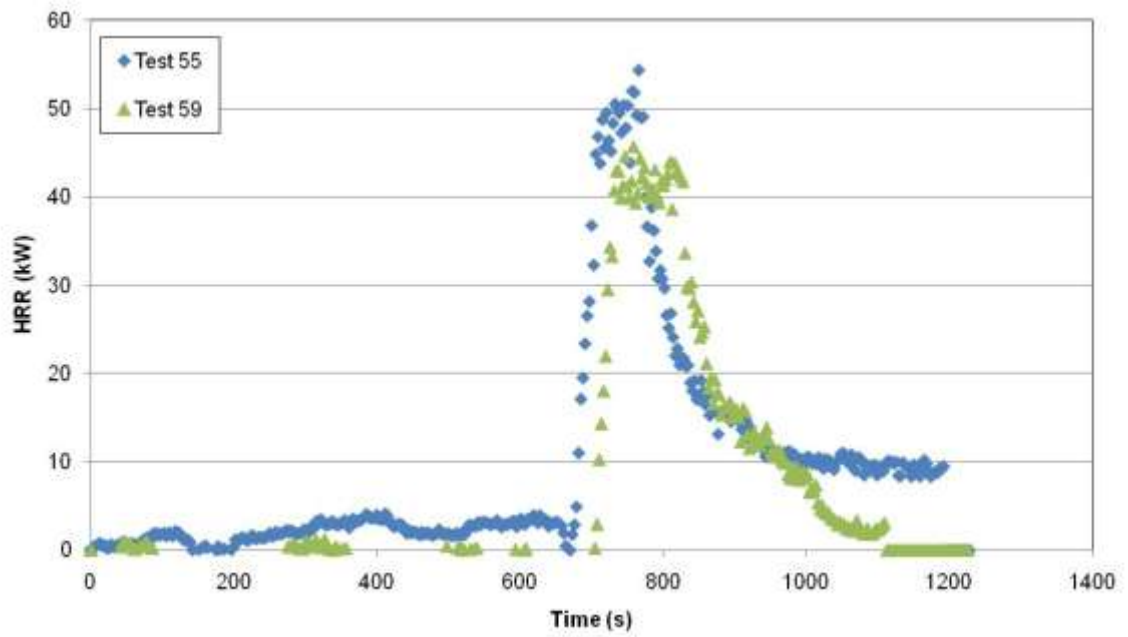
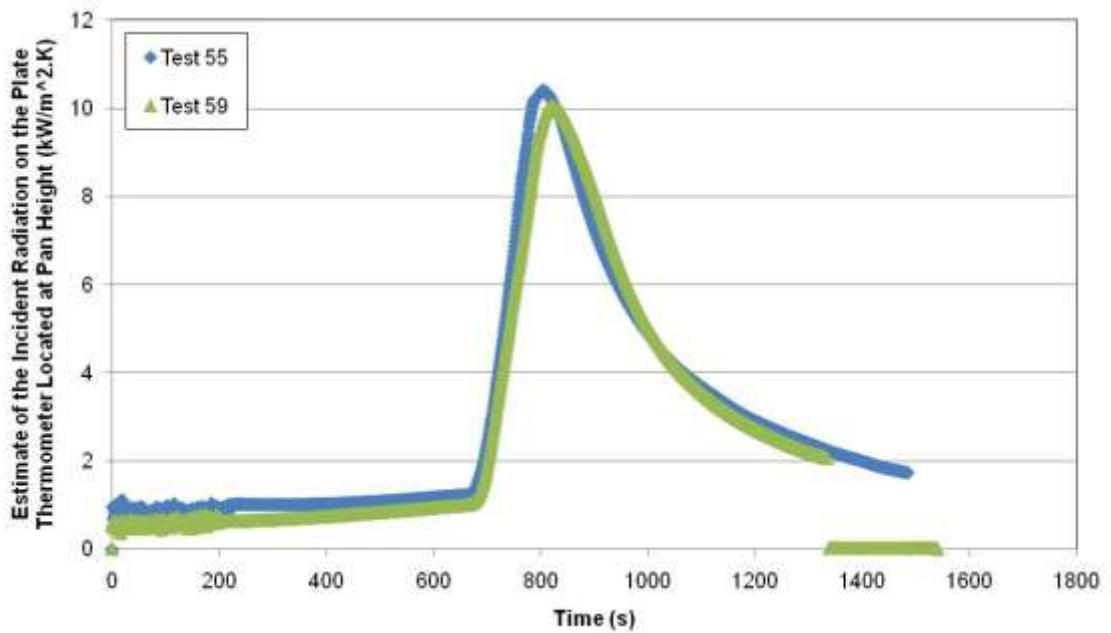
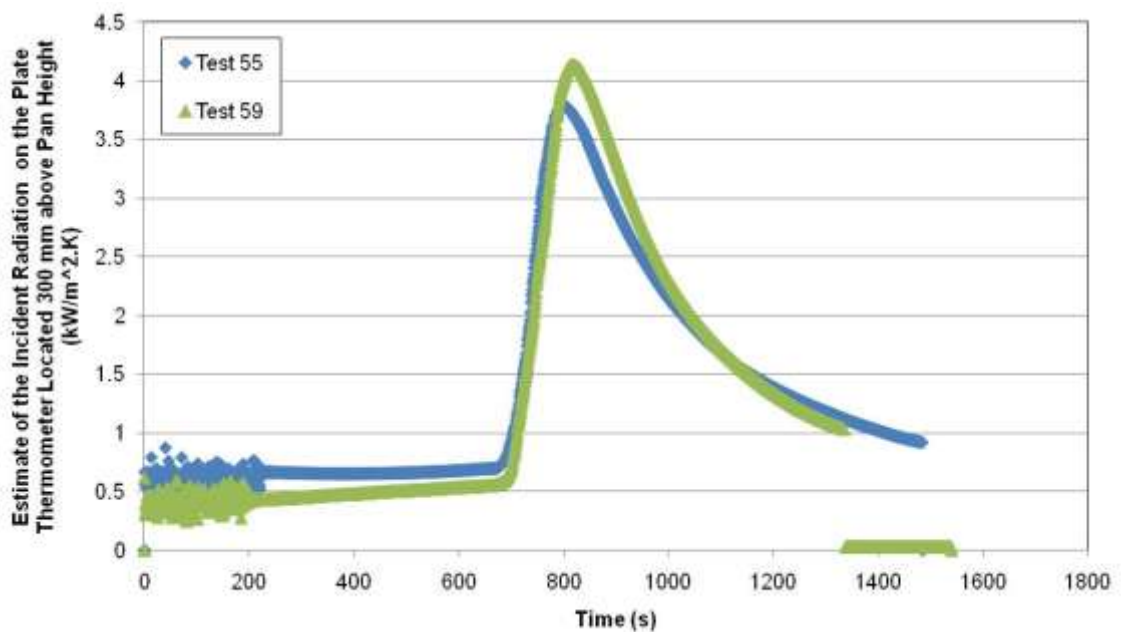

Figure 38: Heat release rates estimated from oxygen calorimetry for Tests 55 and 59.

4.6.1 Analysis



(a)



(b)

Figure 39: Estimates of the incident radiation on the plate thermometer (a) at the height of the lip of the skillet, and (b) 300 mm above the lip of the skillet for Tests 55 and 59.

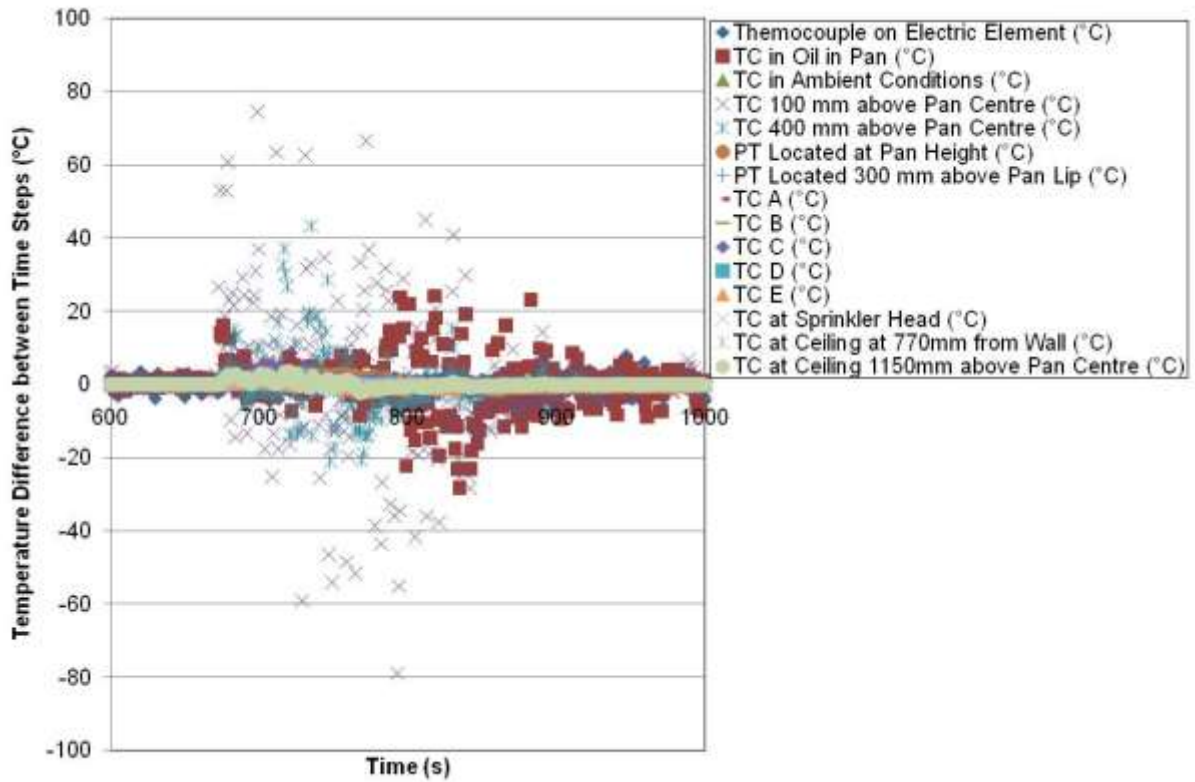

Figure 40: Examples of differences of each of the variable temperatures to between sequential time steps for Test 55.

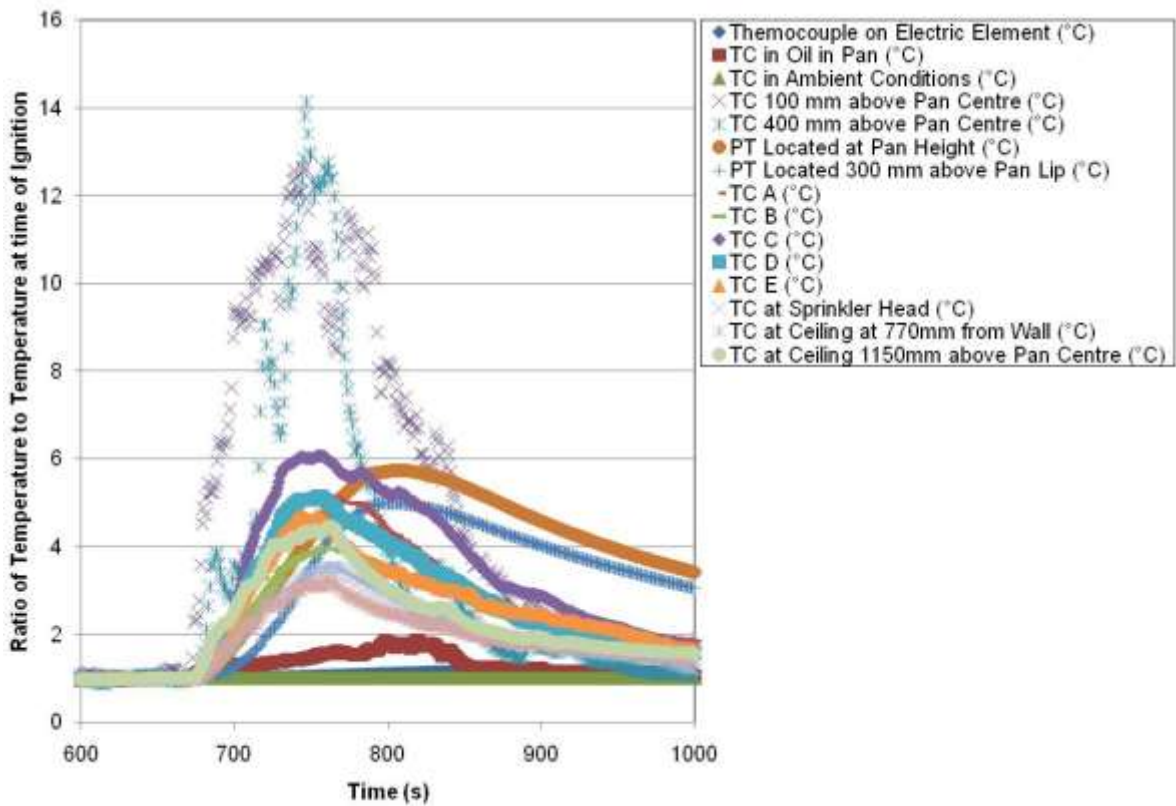

Figure 41: Examples of ratios of each of the variable temperatures to the temperatures at the time of ignition for Test 55.

4.7 Skillet with 200 ml Canola Oil & Bacon, Fan (Test 22)

This test was a free-standing electric stove-top under the furniture calorimeter hood with the fan turned on. The skillet, containing 200 ml of canola oil and two rashers of bacon (43 g), was present on the powered electric element. This test provided a comparison to the tests where cooking oil only was present within the cooking vessel. The measured temperatures are shown in Figure 42. Estimates of the incident radiation on the plate thermometers is shown in Figure 45. Differences between time step measurements of each of the temperatures are shown in Figure 46. Ratios of each of the variable temperatures to the temperatures at the time of ignition are shown in Figure 47.

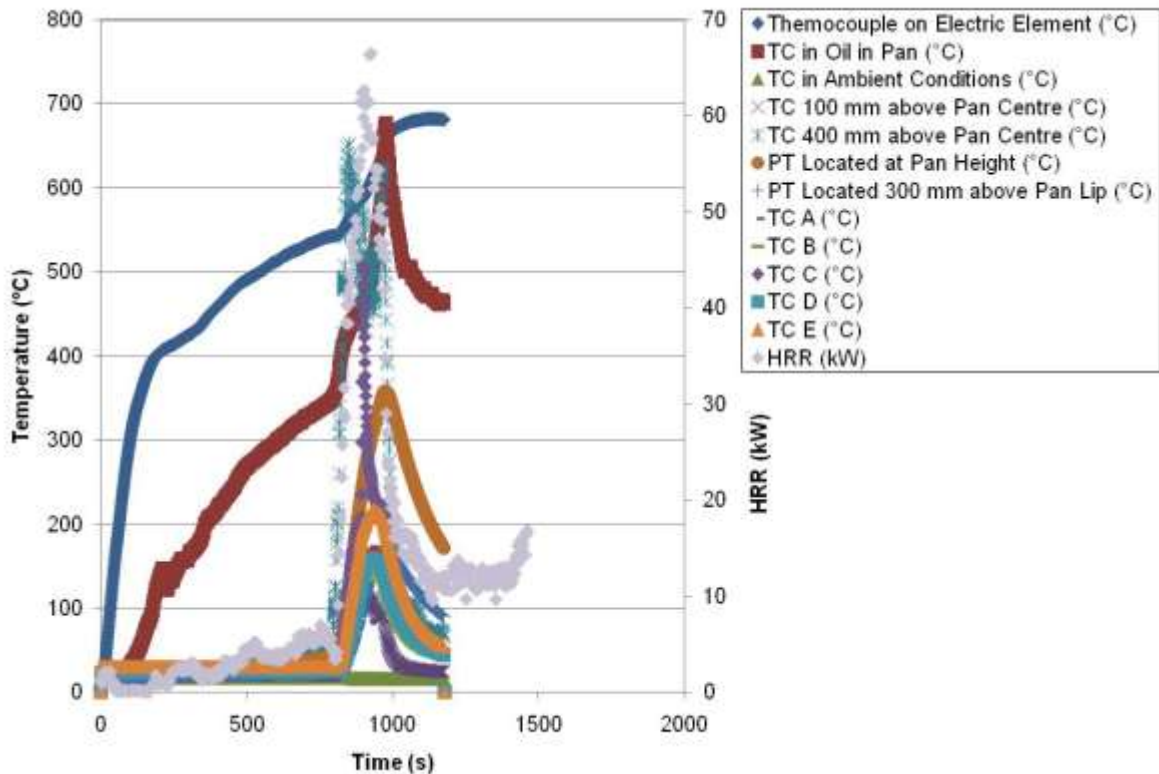

Figure 42: Measured temperatures of the thermocouples and plate thermometers for a dry skillet containing 200 ml canola oil and 2 rashers of bacon on an electric stove-top with the furniture calorimeter fan running (Test 22).

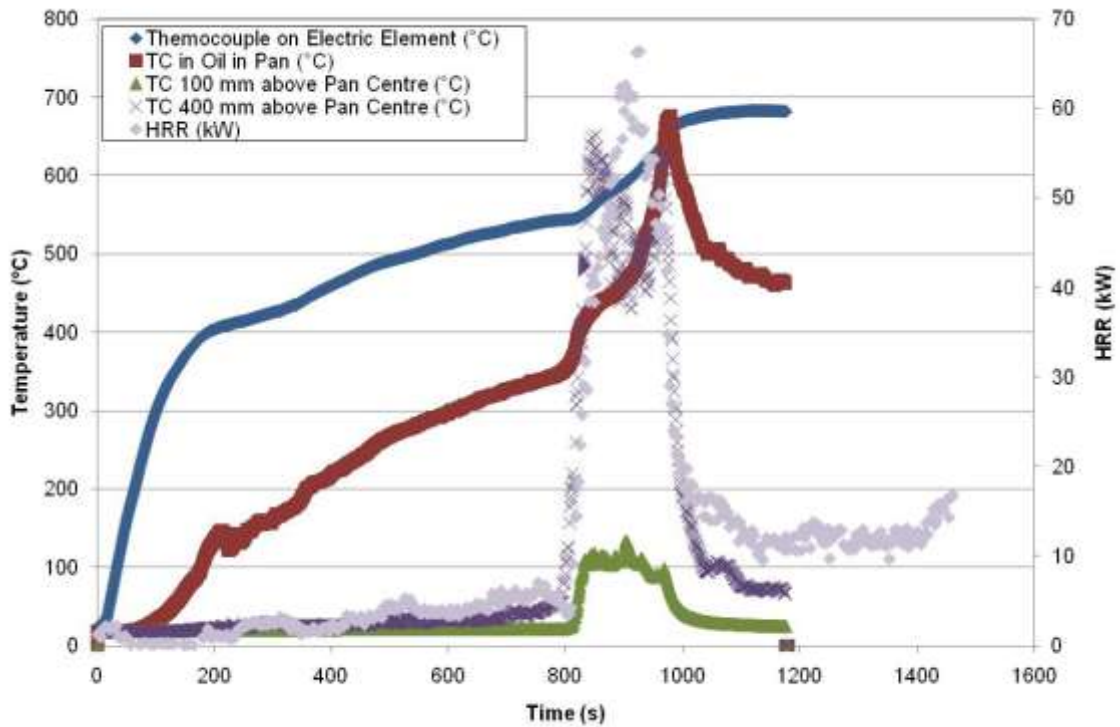

Figure 43: Measured temperatures of the thermocouples along the vertical line from the centre of the heating element for a dry skillet containing 200 ml canola oil and 2 rashers of bacon on an electric stove-top with the furniture calorimeter fan running (Test 22).

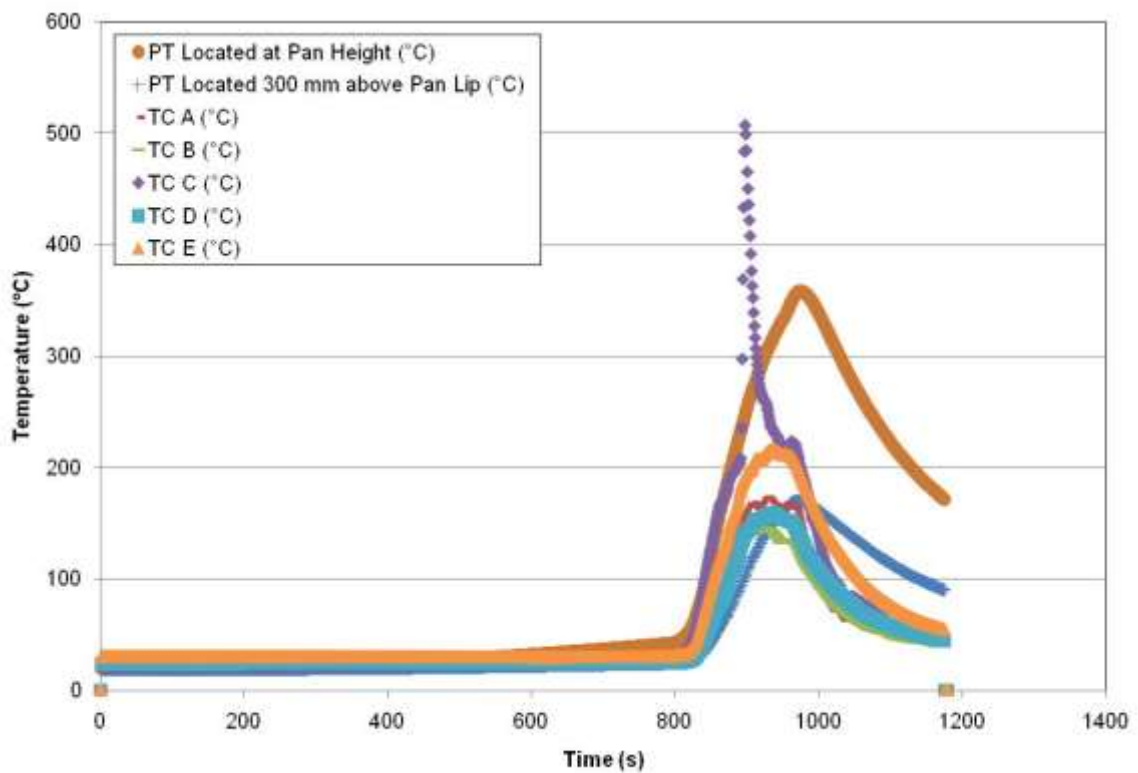

Figure 44: Measured temperatures of the thermocouples on the surface of the stove-top (A-E) and the plate thermometers for a dry skillet containing 200 ml canola oil and 2 rashers of bacon on an electric stove-top with the furniture calorimeter fan running (Test 22).

4.7.1 Analysis

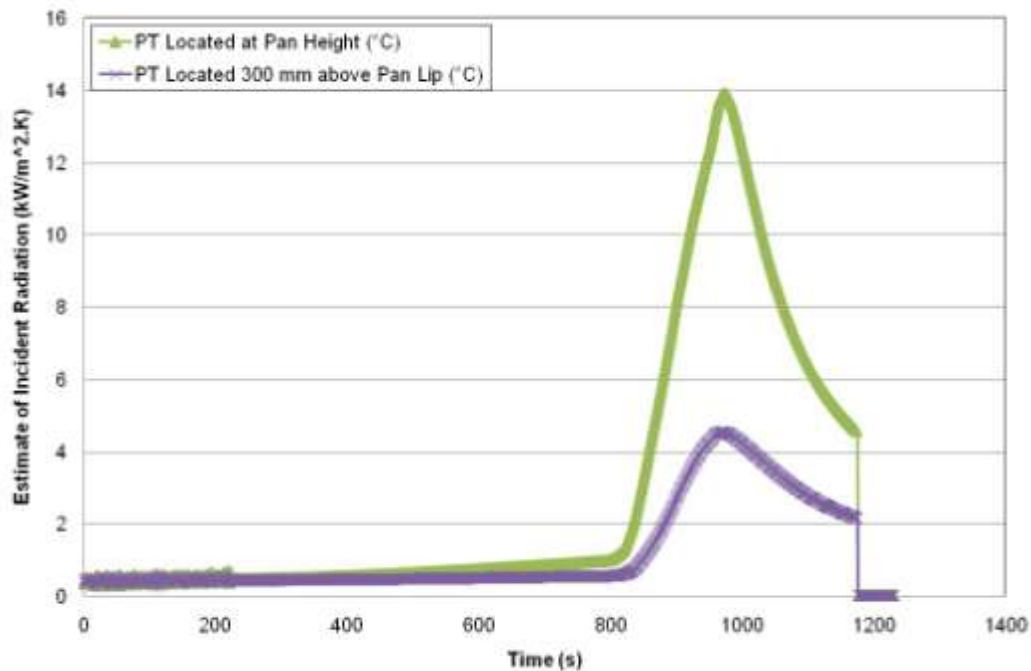

Figure 45: Estimates of the incident radiation for the plate thermometers located 50 mm and 350 mm above the surface of the stove-top for a dry skillet containing 200 ml canola oil and 2 rashers of bacon on an electric stove-top with the furniture calorimeter fan running (Test 22).

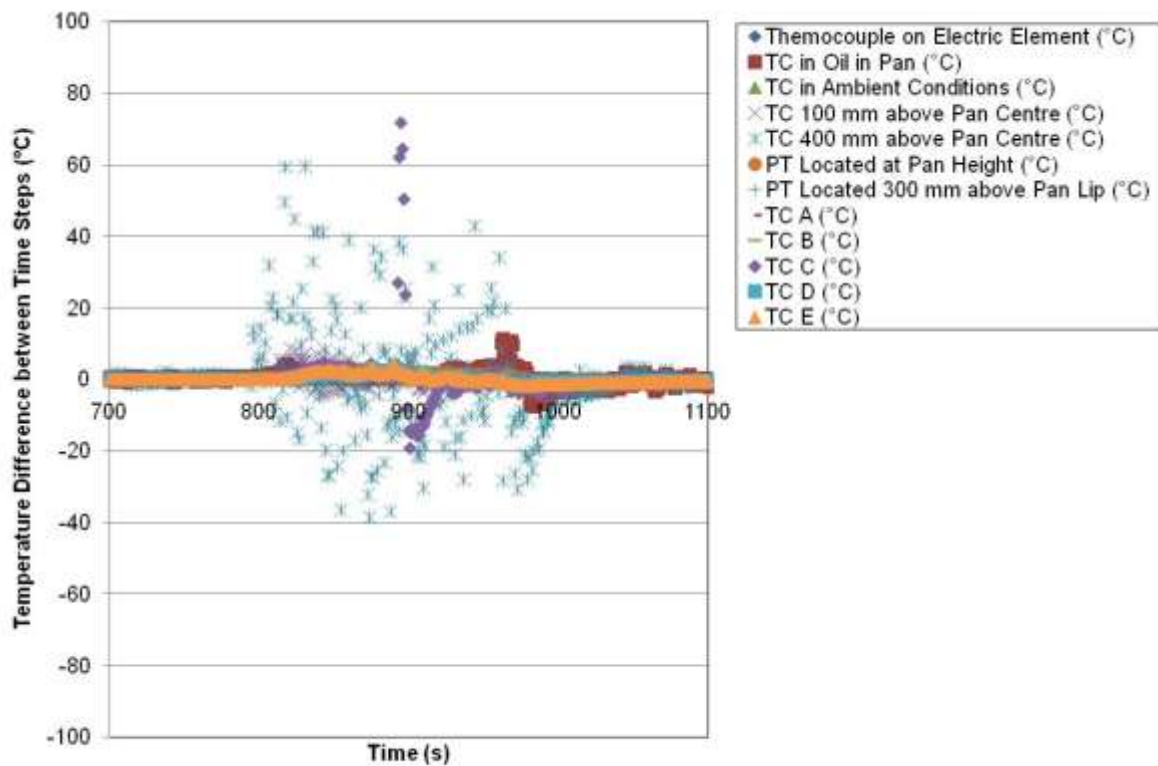

Figure 46: Differences of each of the variable temperatures to between sequential time steps for a dry skillet containing 200 ml canola oil and 2 rashers of bacon on an electric stove-top with the furniture calorimeter fan running (Test 22).

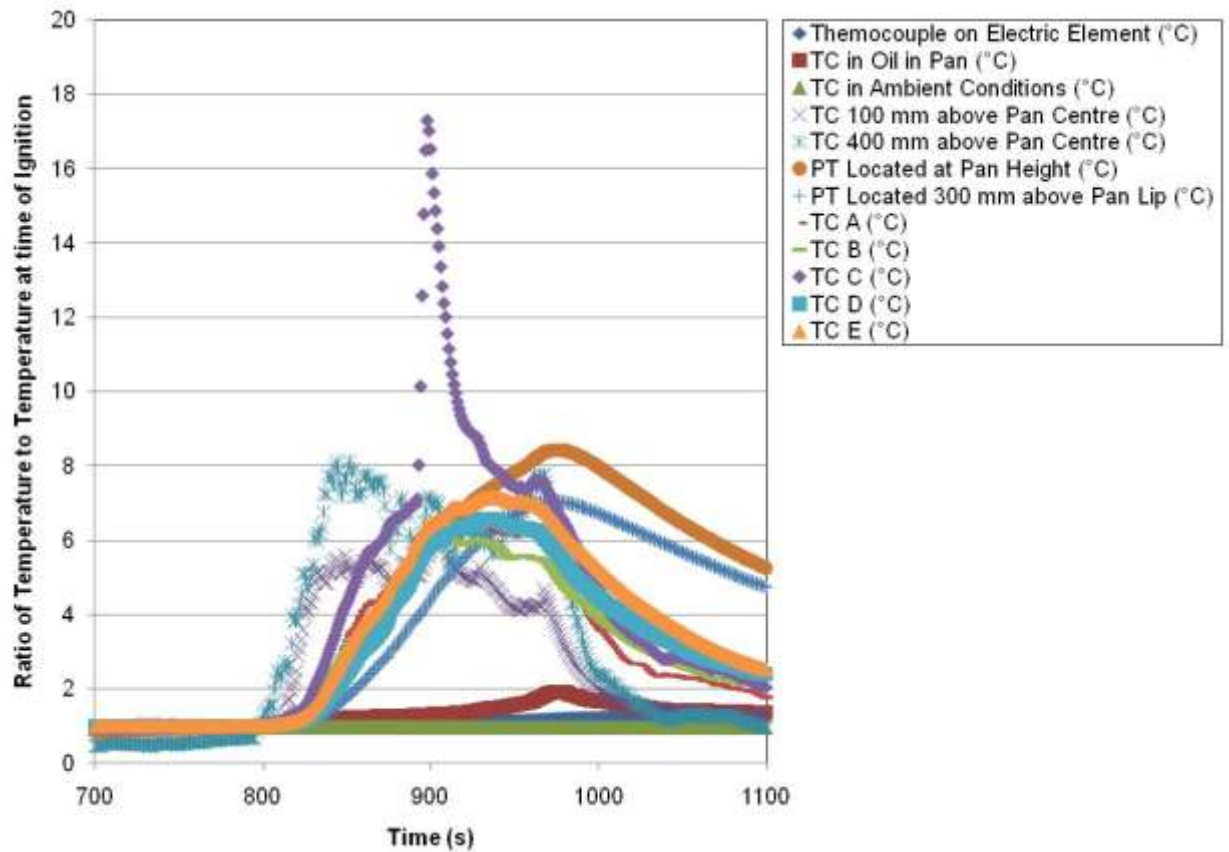

Figure 47: Ratios of each of the variable temperatures to the temperatures at the time of ignition for a dry skillet containing 200 ml canola oil and 2 rashers of bacon on an electric stove-top with the furniture calorimeter fan running (Test 22).

4.8 Skillet with 200 ml Canola Oil & 20 ml Water, Fan (Test 43)

This test was a free-standing electric stove-top under the furniture calorimeter hood with the fan turned on. The skillet, containing 200 ml of canola oil and 20 ml water, was present on the powered electric element at the beginning of the test. The small amount of water present in the oil was to simulate the cooking vessel being rinsed but not dried before use or food with a small amount of water contained within it. Test 43 was an example of this situation and provided a comparison to the tests where cooking oil only was present within the cooking vessel and where types of food (i.e. bread, bacon and potatoes) were included in the cooking oil. The measured temperatures are shown in Figure 48. Estimates of the incident radiation on the plate thermometers is shown in Figure 51. Differences between time step measurements of each of the temperatures are shown in Figure 52. Ratios of each of the variable temperatures to the temperatures at the time of ignition are shown in Figure 53.

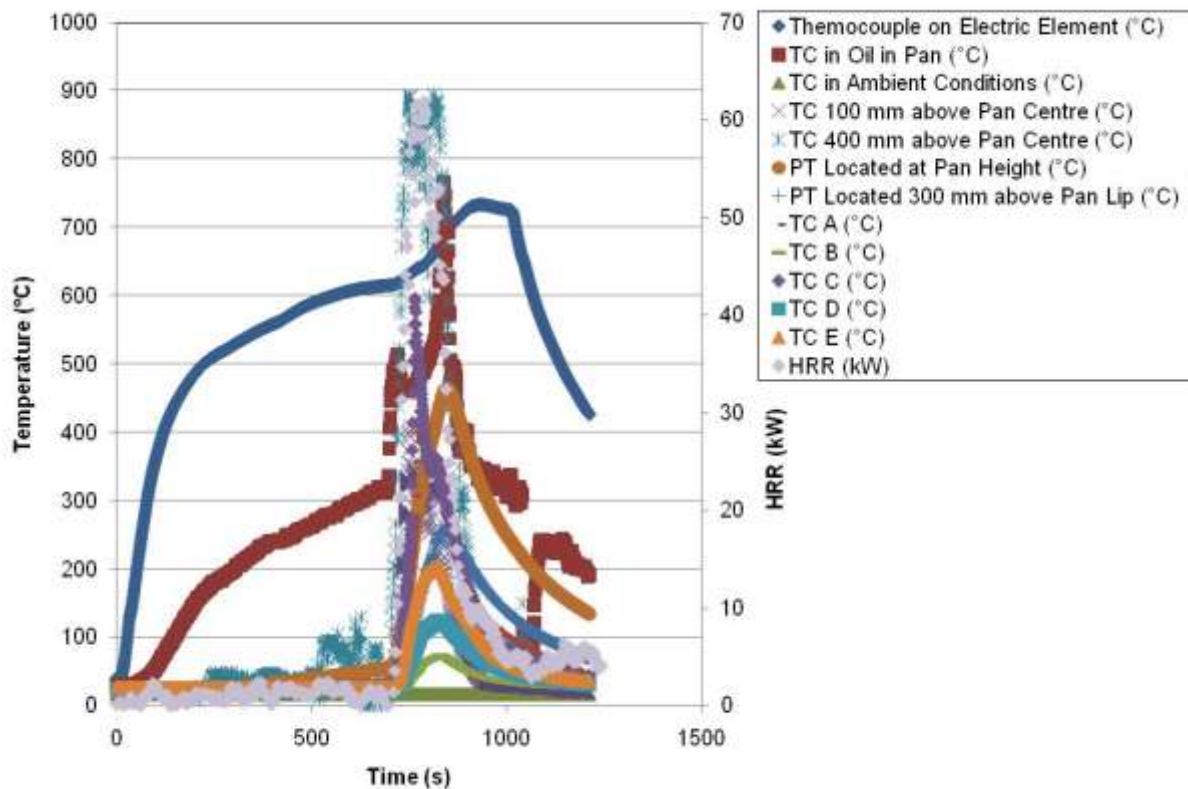

Figure 48: Measured temperatures of the thermocouples and plate thermometers for a skillet containing 200 ml canola oil and 20 ml water on an electric stove-top with the furniture calorimeter fan running (Test 43).

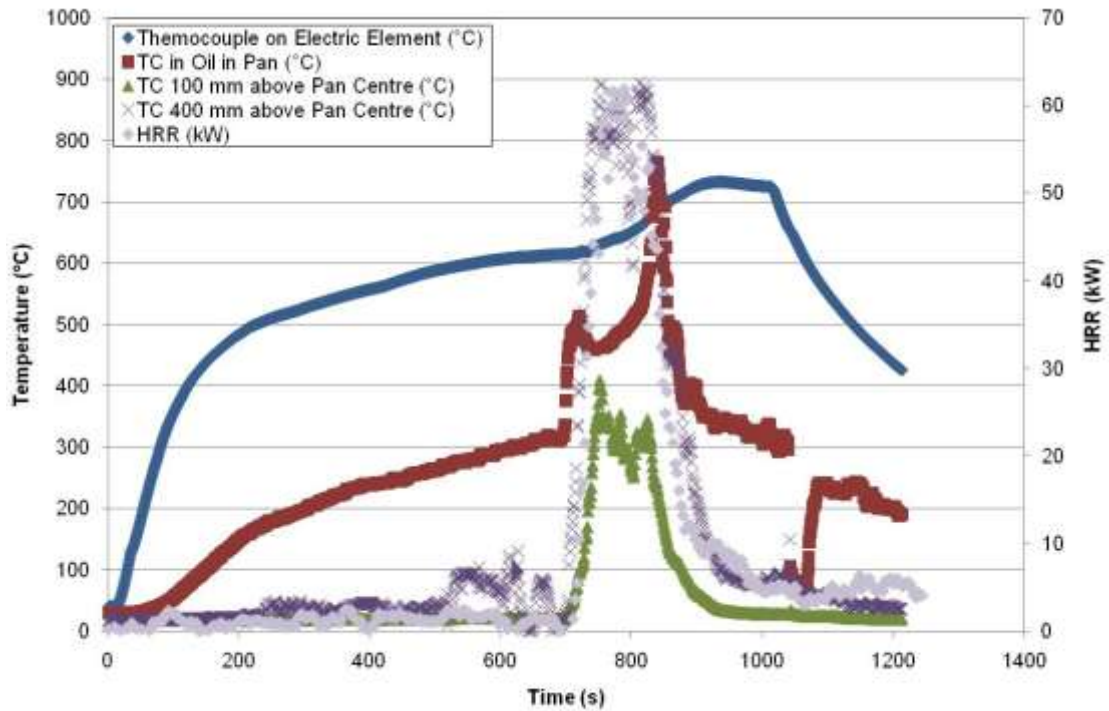

Figure 49: Measured temperatures of the thermocouples in a vertical line above the centre of the heating element for a skillet containing 200 ml canola oil and 20 ml water on an electric stove-top with the furniture calorimeter fan running (Test 43).

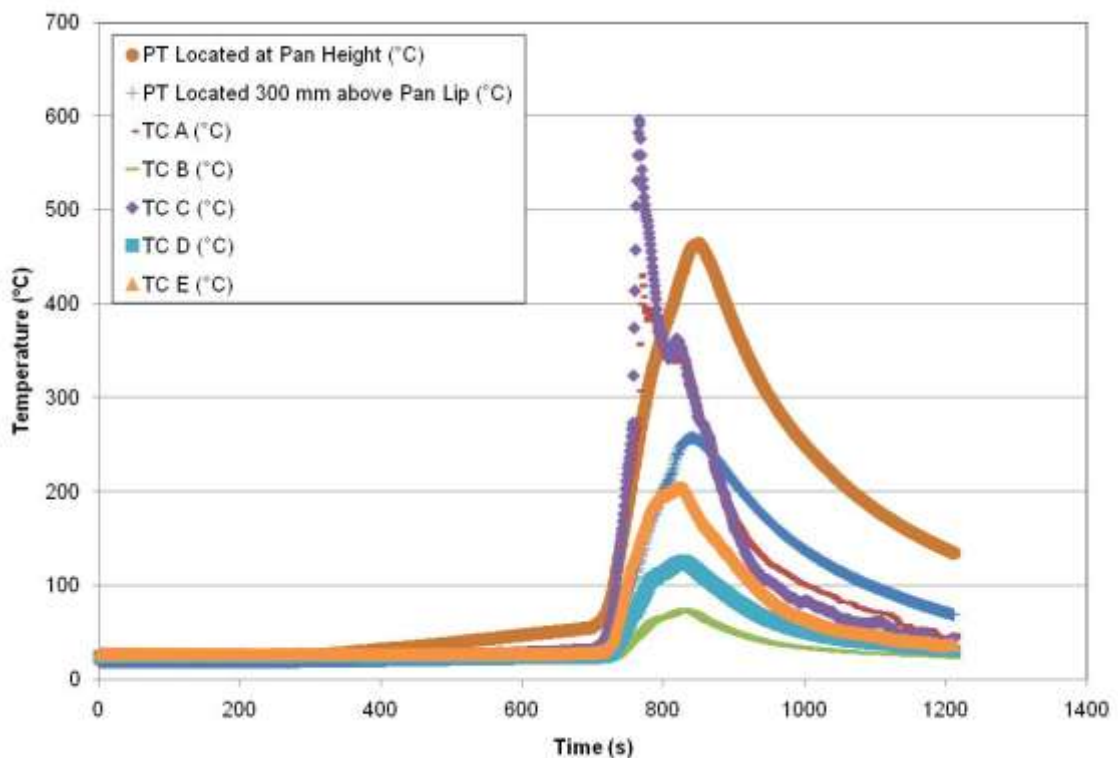

Figure 50: Measured temperatures of the thermocouples on the surface of the stove-top (A-E) and plate thermometers for a skillet containing 200 ml canola oil and 20 ml water on an electric stove-top with the furniture calorimeter fan running (Test 43).

4.8.1 Analysis

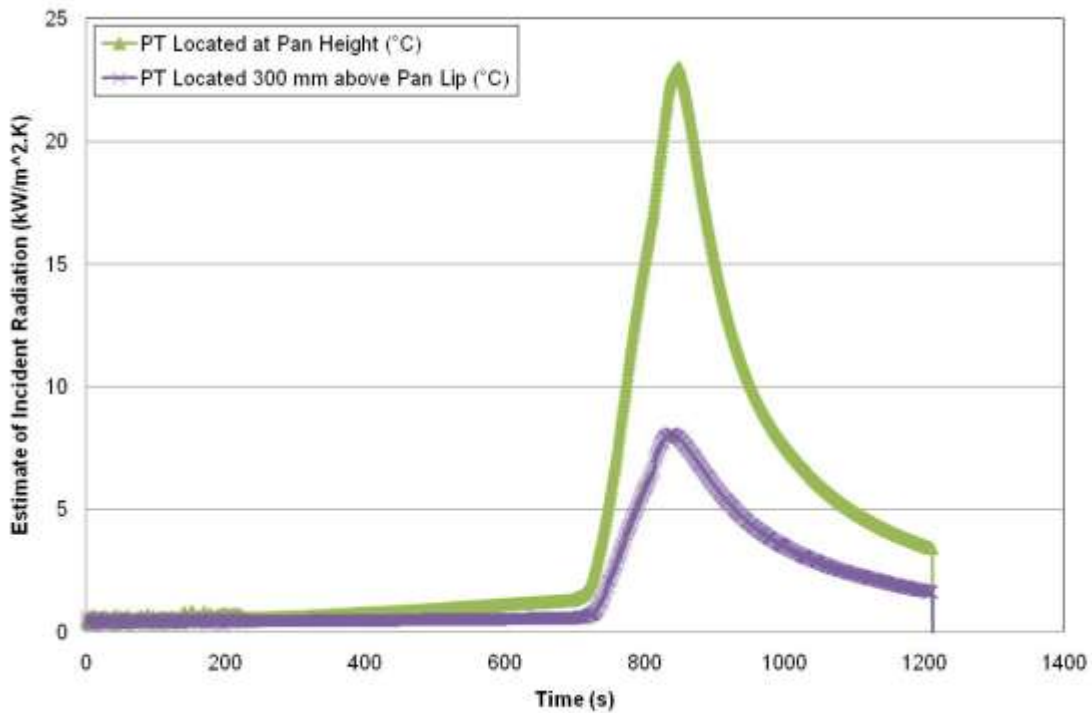

Figure 51: Estimates of the incident radiation for the plate thermometers located 50 mm and 350 mm above the surface of the stove-top for a skillet containing 200 ml canola oil and 20 ml water on an electric stove-top with the furniture calorimeter fan running (Test 43).

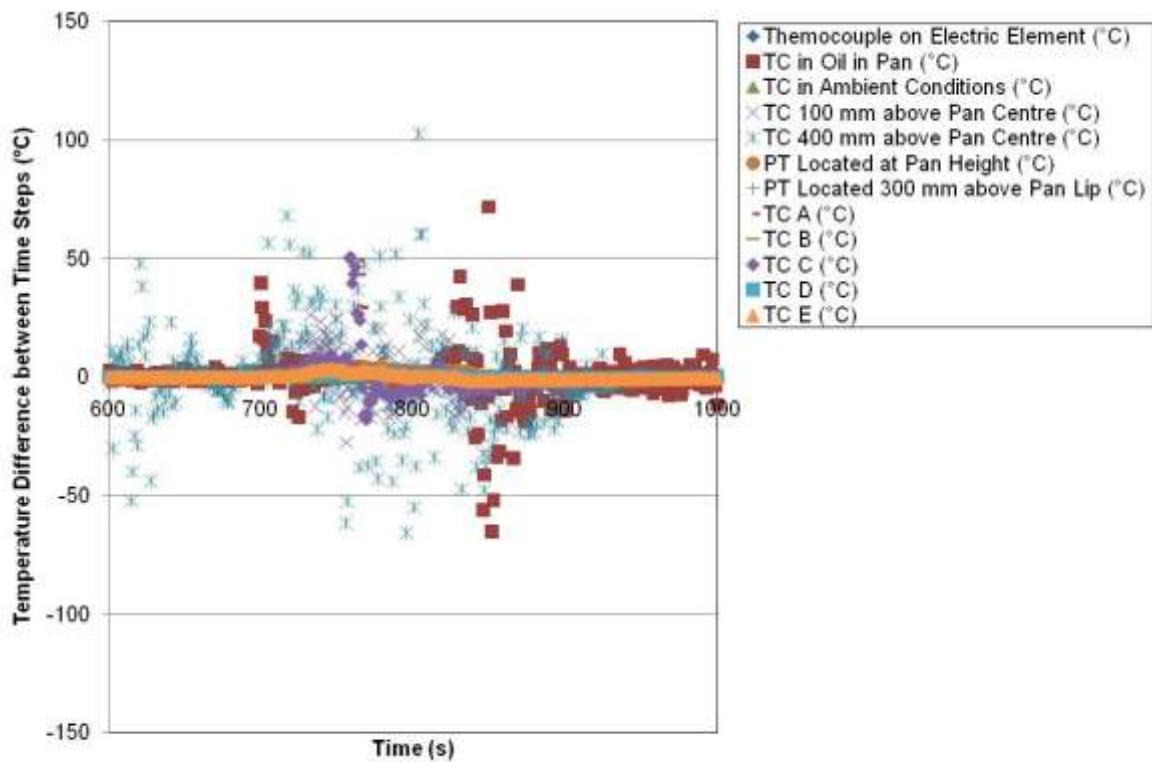

Figure 52: Differences of each of the variable temperatures to between sequential time steps for a skillet containing 200 ml canola oil and 20 ml water on an electric stove-top with the furniture calorimeter fan running (Test 43).

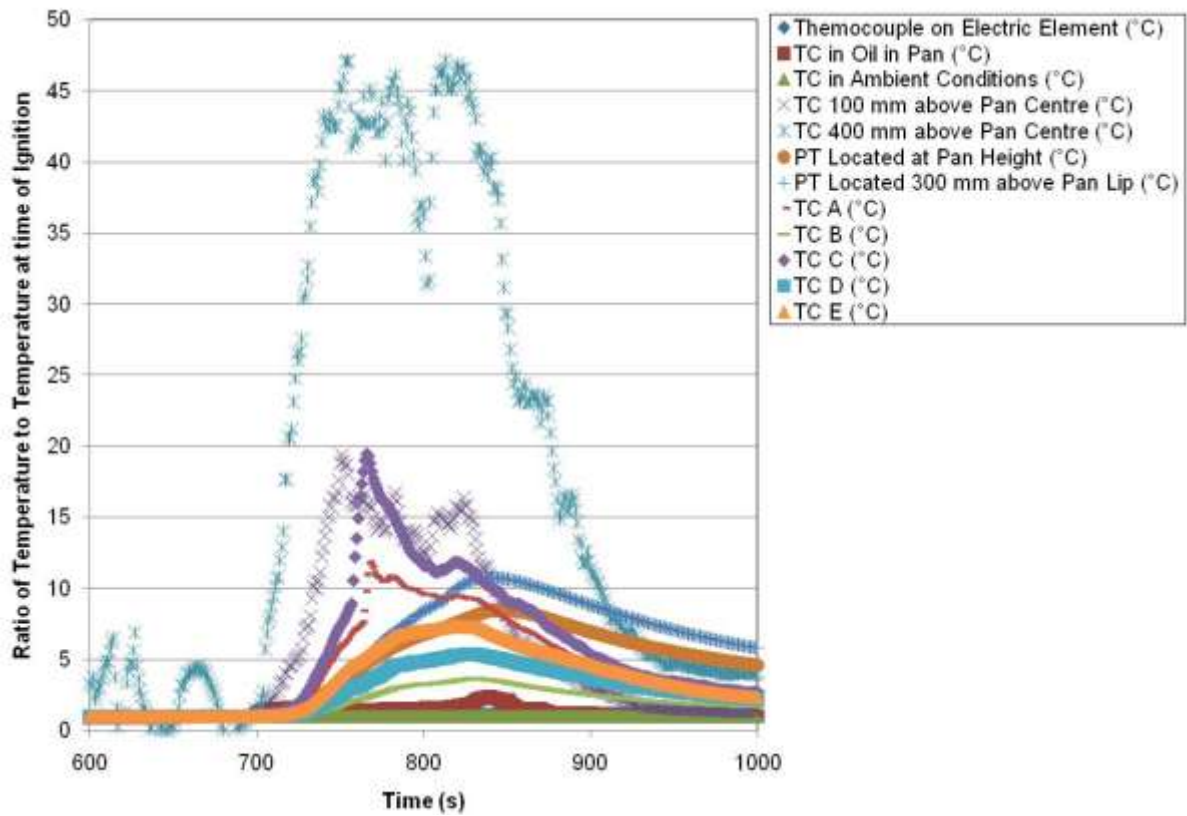
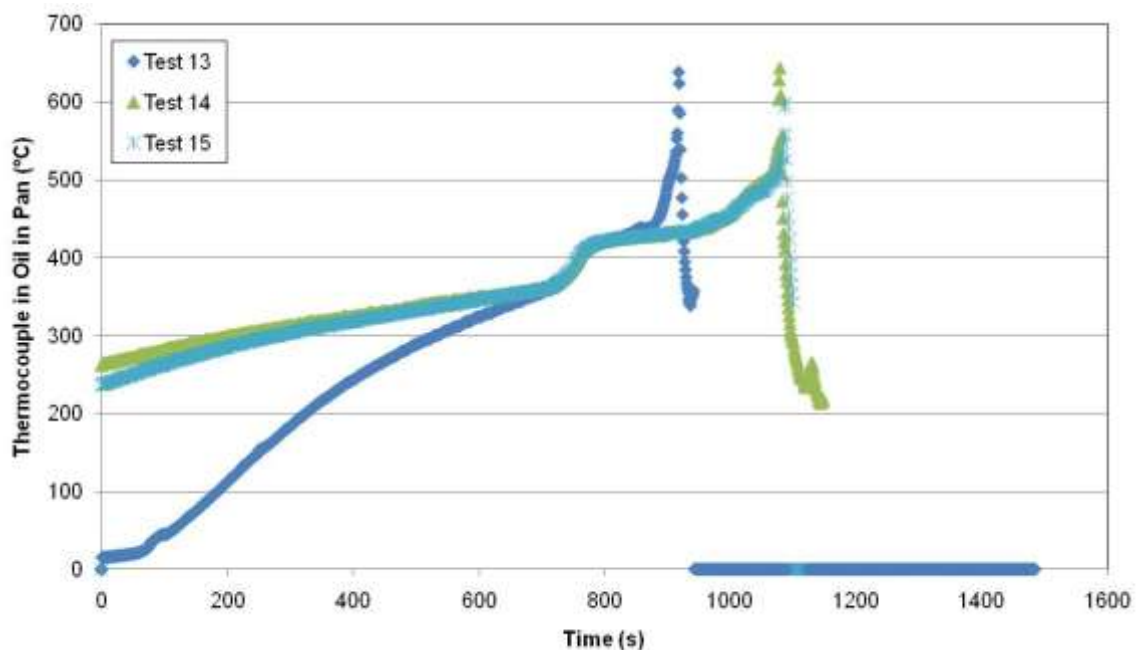

Figure 53: Ratios of each of the variable temperatures to the temperatures at the time of ignition for a skillet containing 200 ml canola oil and 20 ml water on an electric stove-top with the furniture calorimeter fan running (Test 43).

4.9 Small Pan with 200 ml Canola Oil, Fan (Tests 13 – 15)

This test was a free-standing electric stove-top under the furniture calorimeter hood with the fan turned on (also allowing data to be collected for the heat release rate). The small pan, with 200 ml of canola oil, was present on the powered electric element. This test formed a comparison to the results for the setup with a free-standing stove-top and flaming 200 ml canola oil with the extraction fan running (e.g. Section 4.3). Tests 13 to 15 are examples of this scenario.

The thermocouple measurements in the oil and above the centre of the pan are shown in Figure 54. Plate thermometer temperature measurements are shown in Figure 55. Thermocouple measurements for locations on the surface of the stove-top are shown in Figure 56. Heat release rates based on oxygen calorimetry are shown in Figure 57. Estimates of the incident radiation on the plate thermometers are shown in Figure 58. An example of the temperature differences between sequential time steps for each of the variables recorded is shown in Figure 59 for Test 14 (where the time shown is based on the original test data, as included in Appendices C and D). An example of the ratios of temperatures to the temperature at the time of ignition for each of the variables recorded is shown in Figure 60 for Test 14 (where the time shown is based on the original test data, as included in Appendices C and D). Note that during Test 13 the base of the pan was observed to warp to form a convex surface against the element and subsequently moved during the test.



(a)

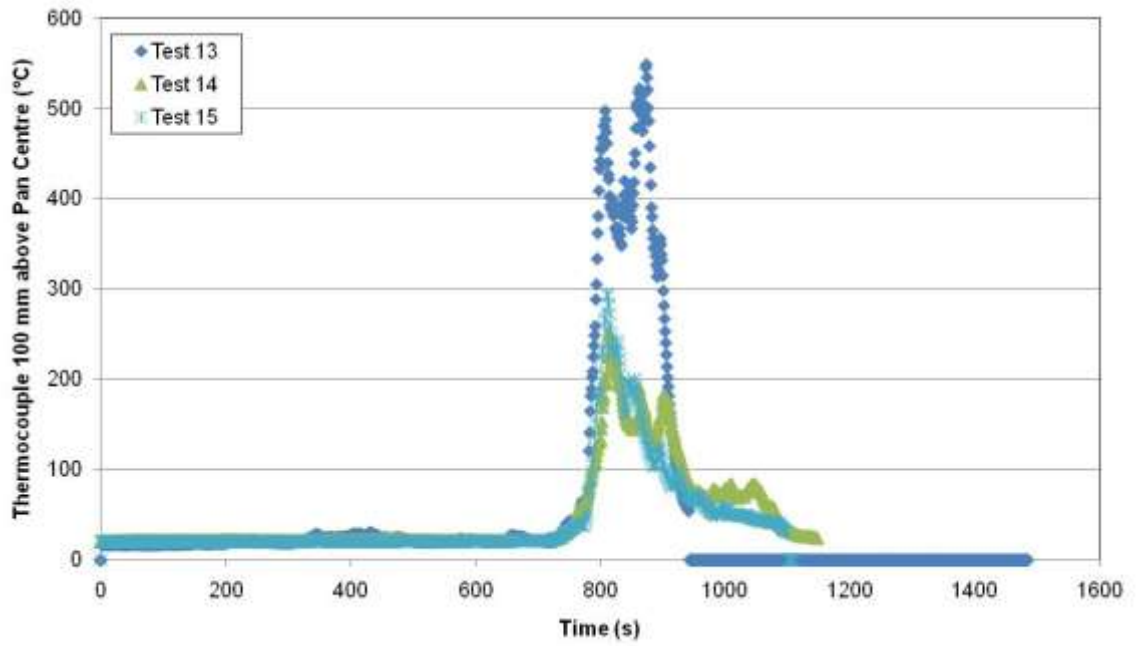

(b)

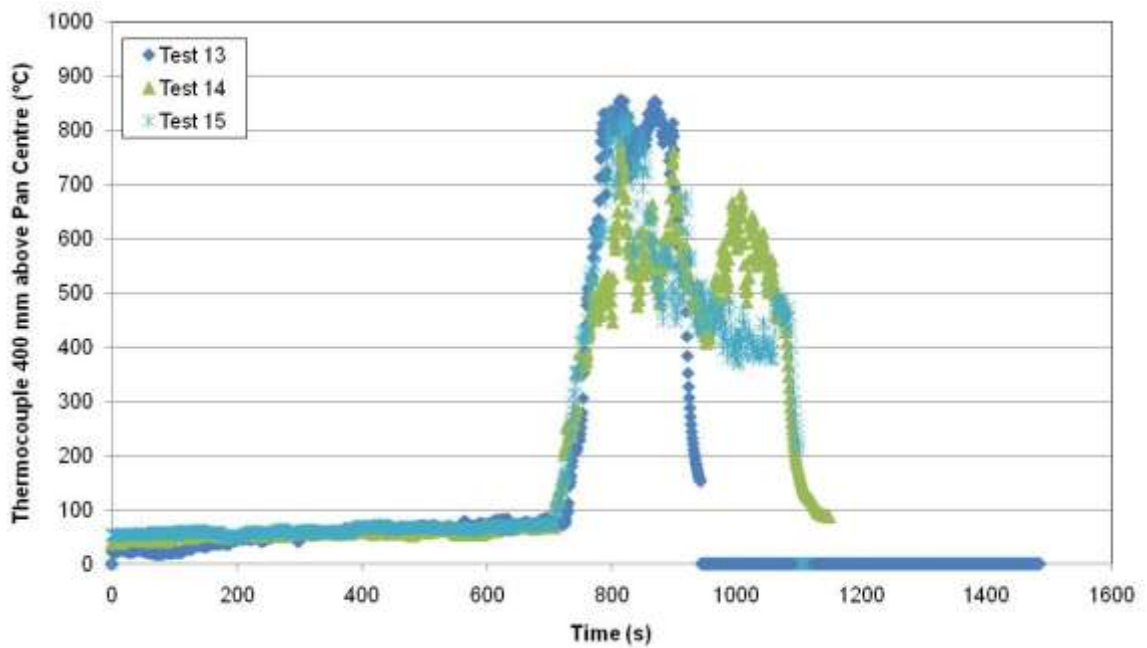

(c)

Figure 54: Thermocouple measurements for the thermocouple located (a) in the oil in the small pan, (b) 100 mm above the centre of the skillet, and (c) 400 mm above the centre of the small pan for Tests 13 – 15.

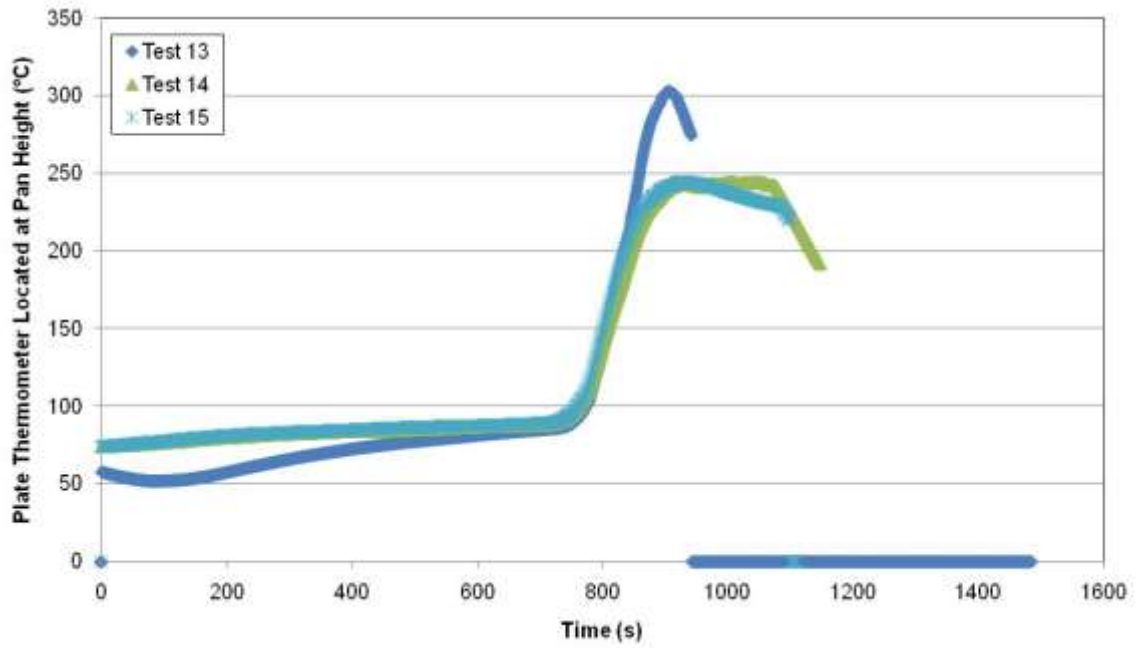

(a)

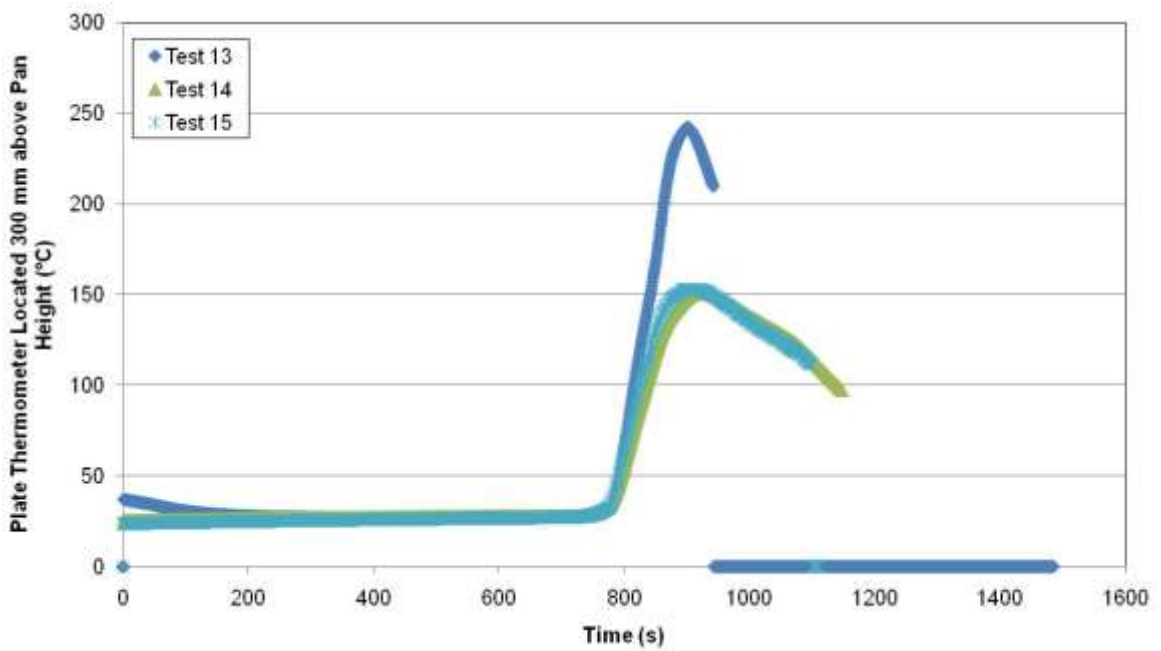

(b)

Figure 55: Plate thermometer temperature measurements for (a) 50 mm above the surface of the stove-top, and (b) 350 mm above the surface of the stove-top for Tests 13 – 15.

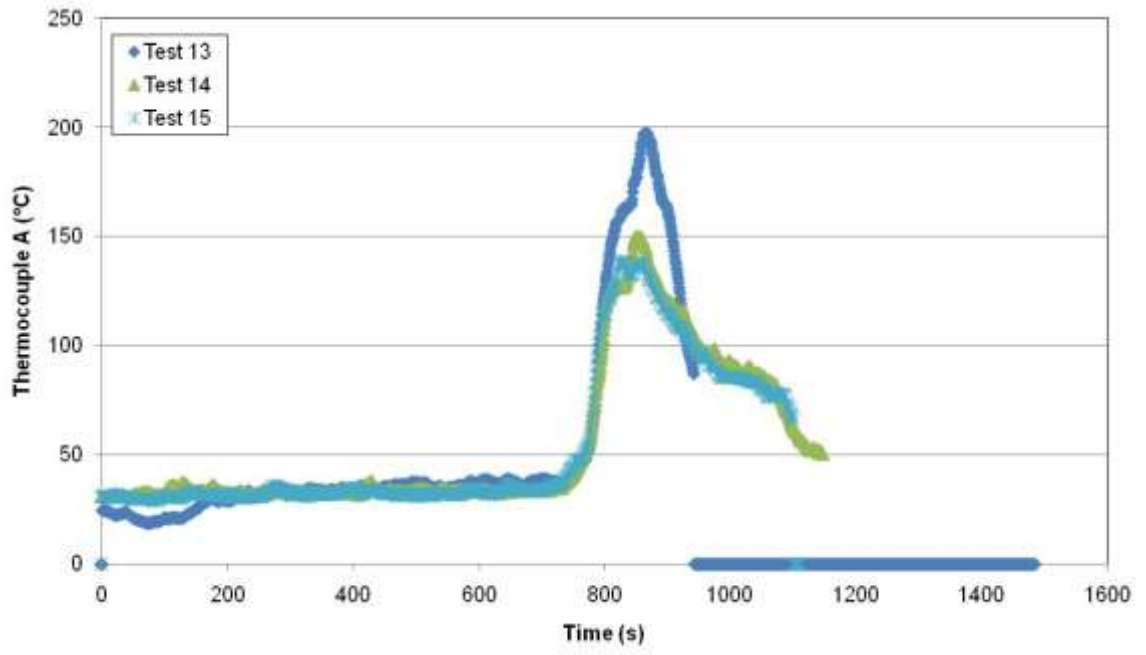

(a)

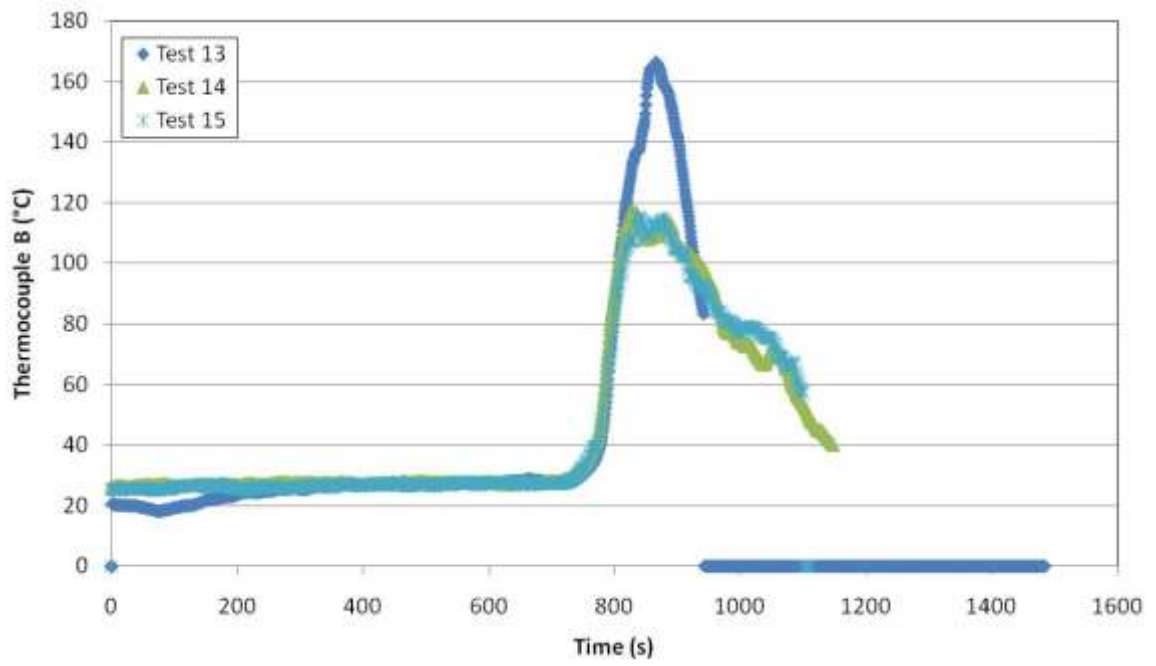

(b)

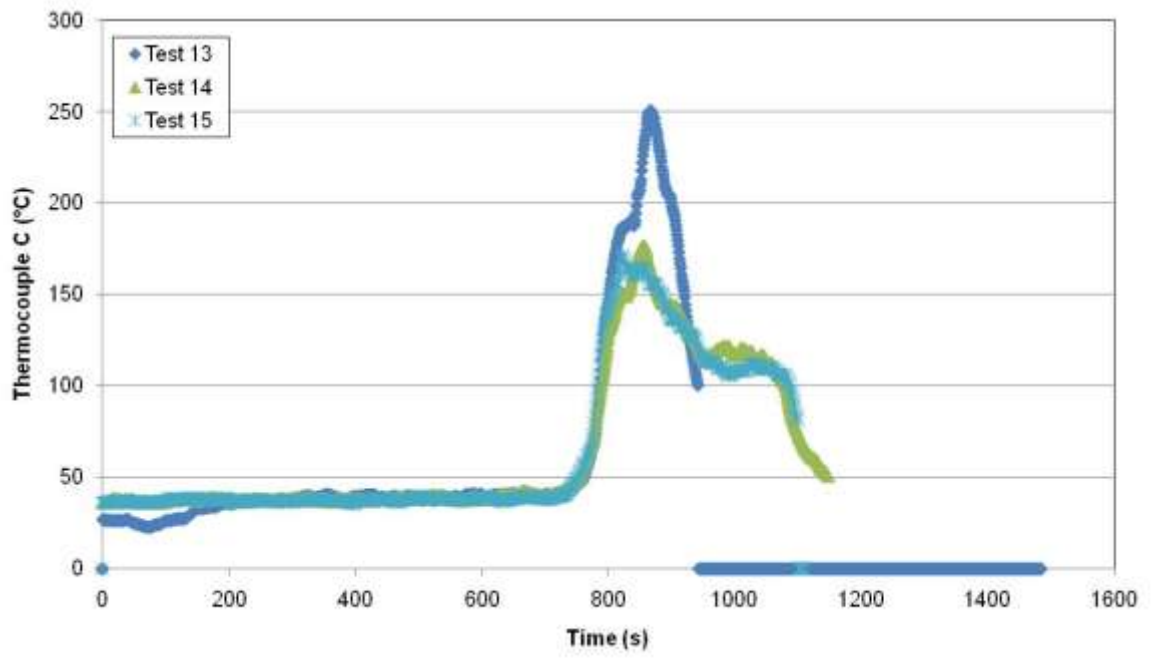

(c)

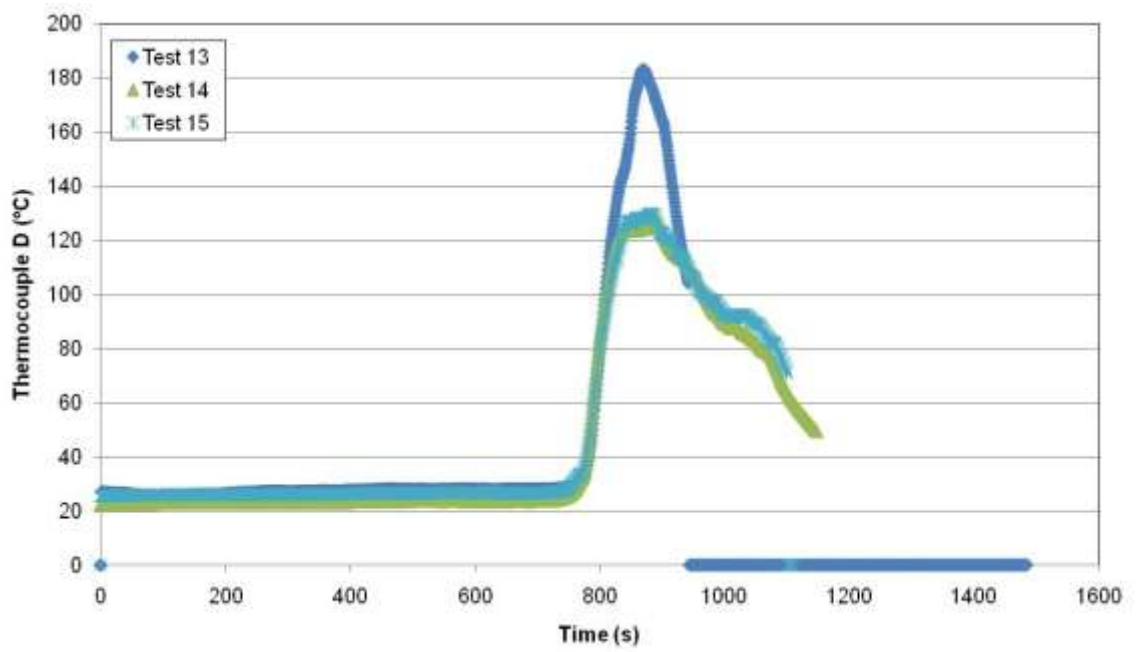

(d)

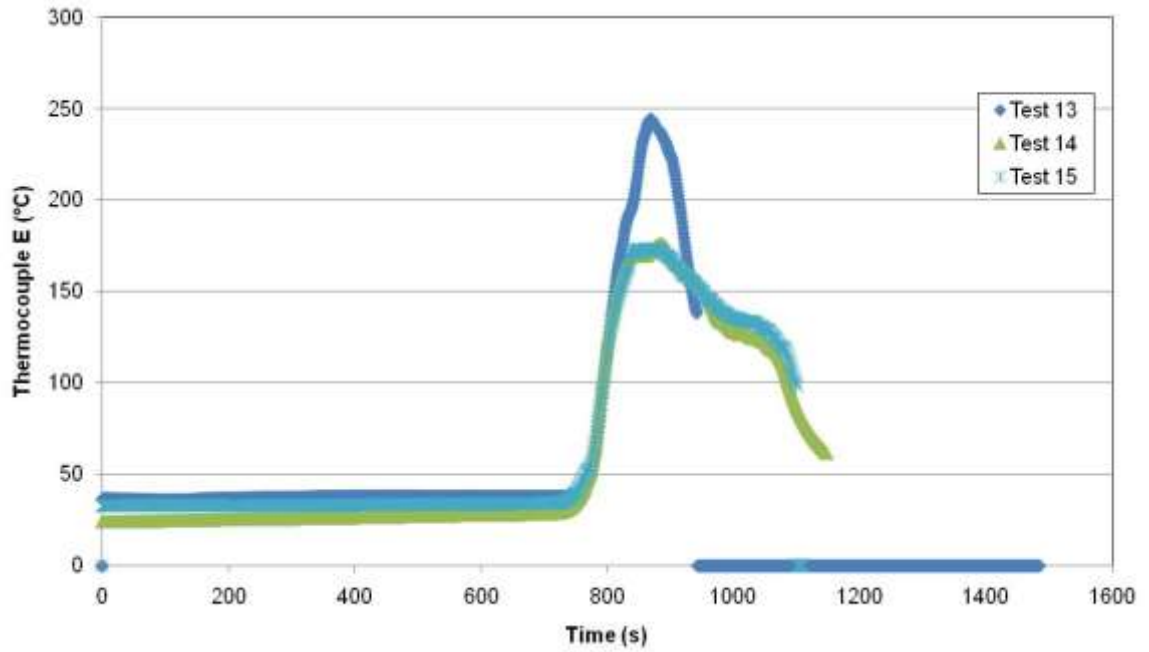

(e)

Figure 56: Thermocouple measurements of (a) thermocouple A, (b) thermocouple B, (c) thermocouple C, (d) thermocouple D, and (e) thermocouple E for Tests 13 – 15.

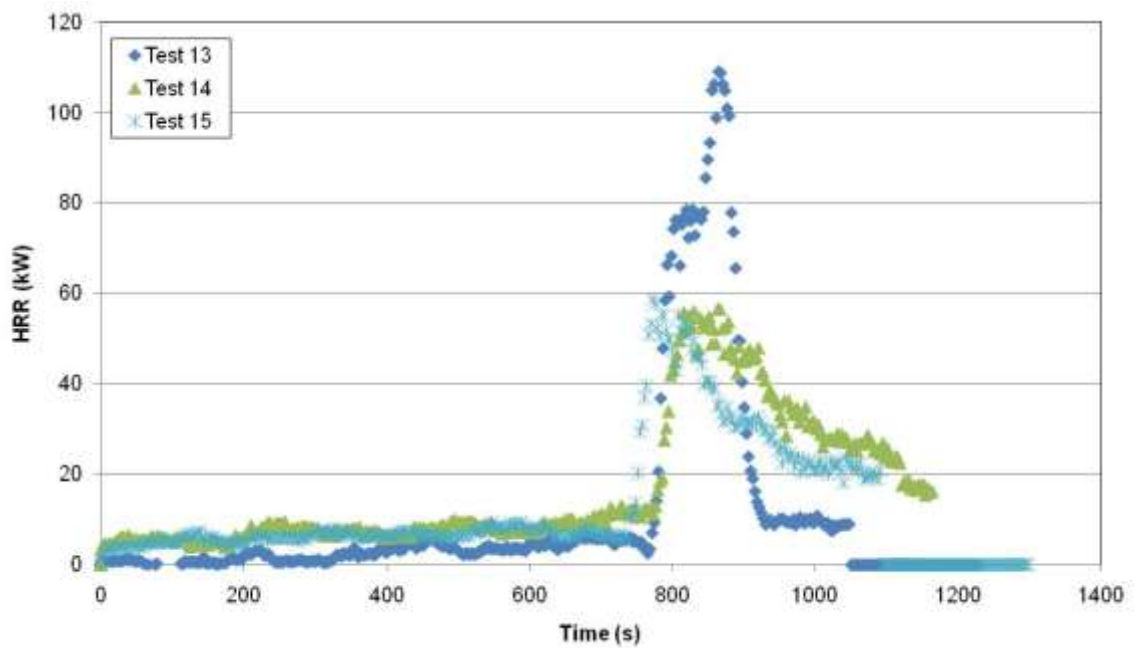
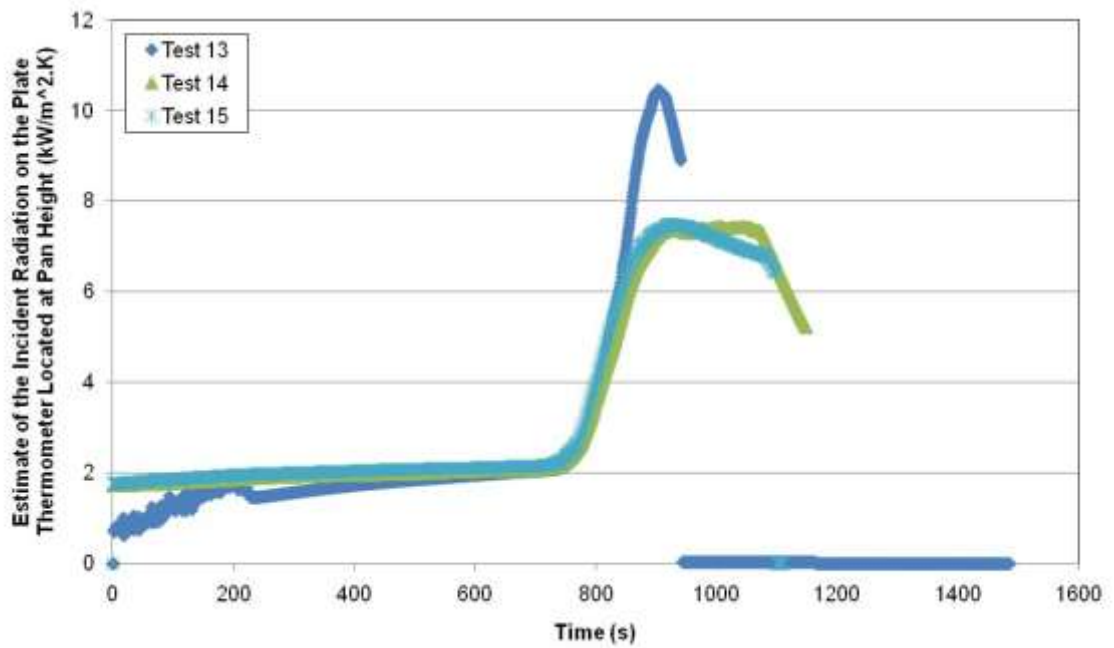
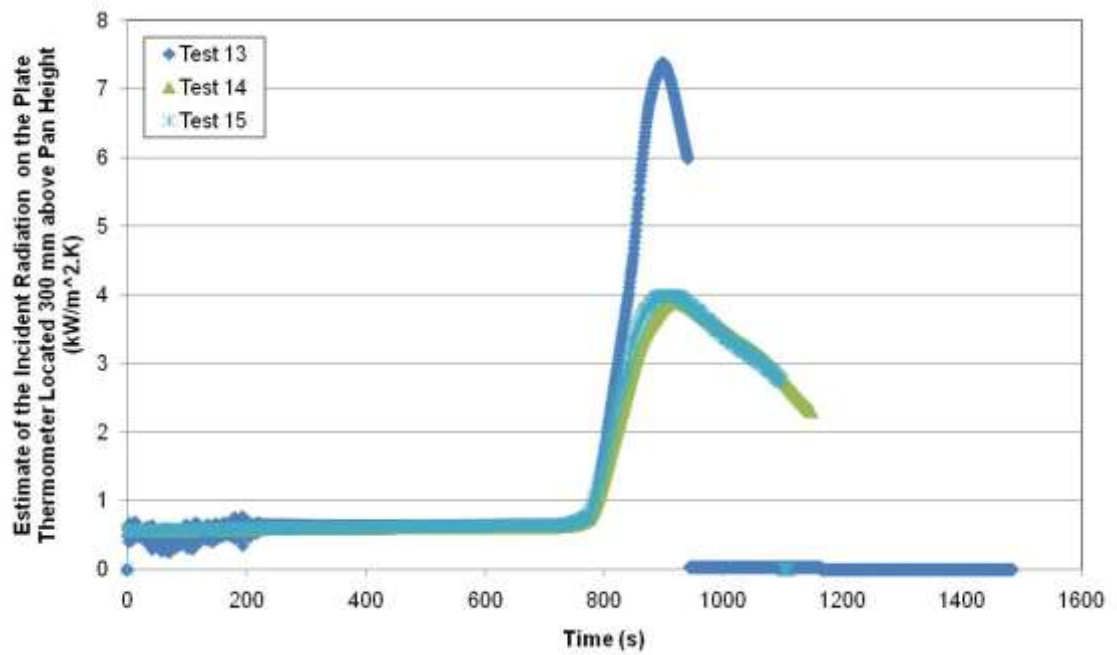

Figure 57: Heat release rates estimated from oxygen calorimetry for Tests 13 – 15.

4.9.1 Analysis



(a)



(b)

Figure 58: Estimates of the incident radiation on the plate thermometer (a) 50 mm and (b) 350 mm above the surface of the stove-top for Tests 13 – 15.

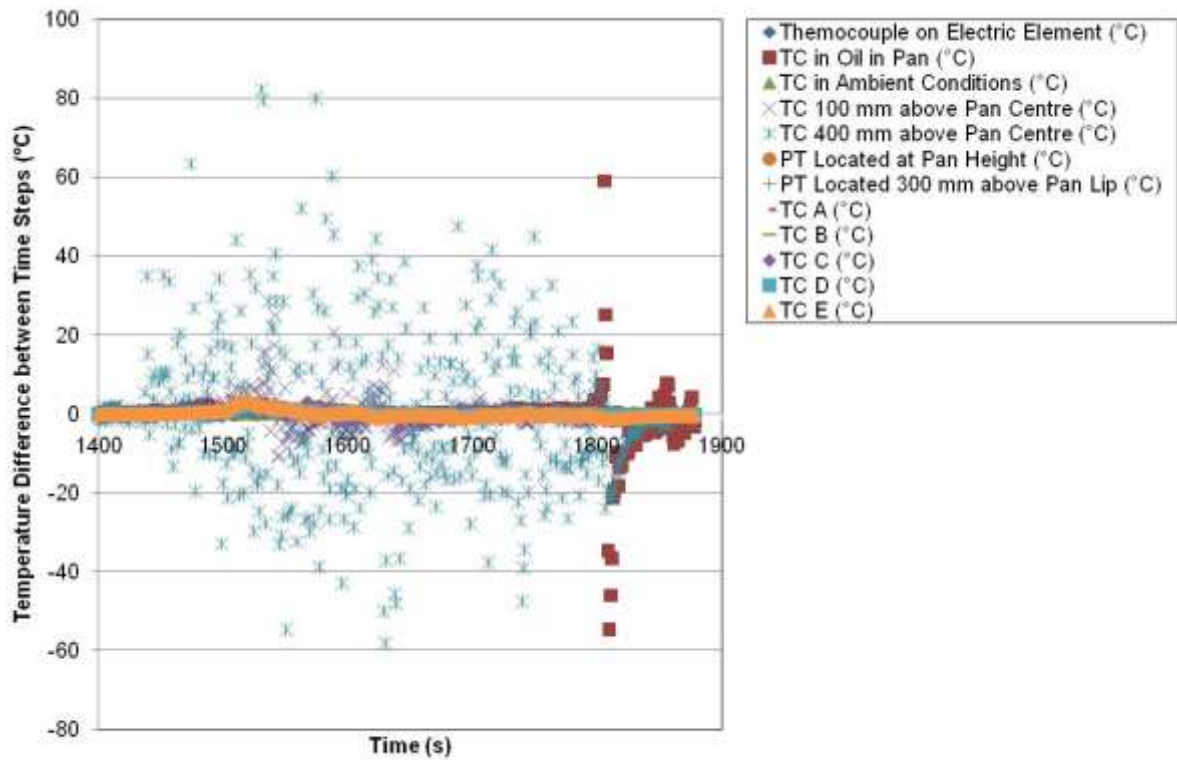

Figure 59: An example of the differences of each of the variable temperatures to between sequential time steps for Test 14.

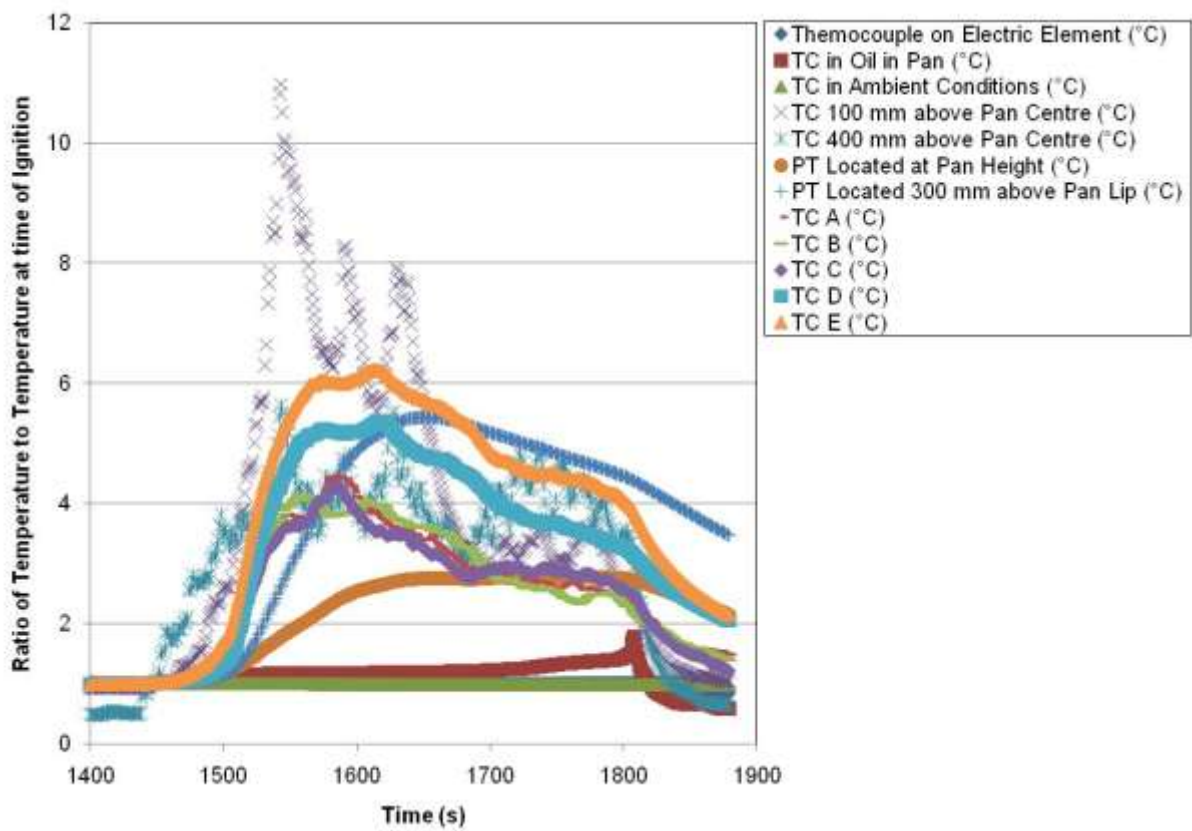
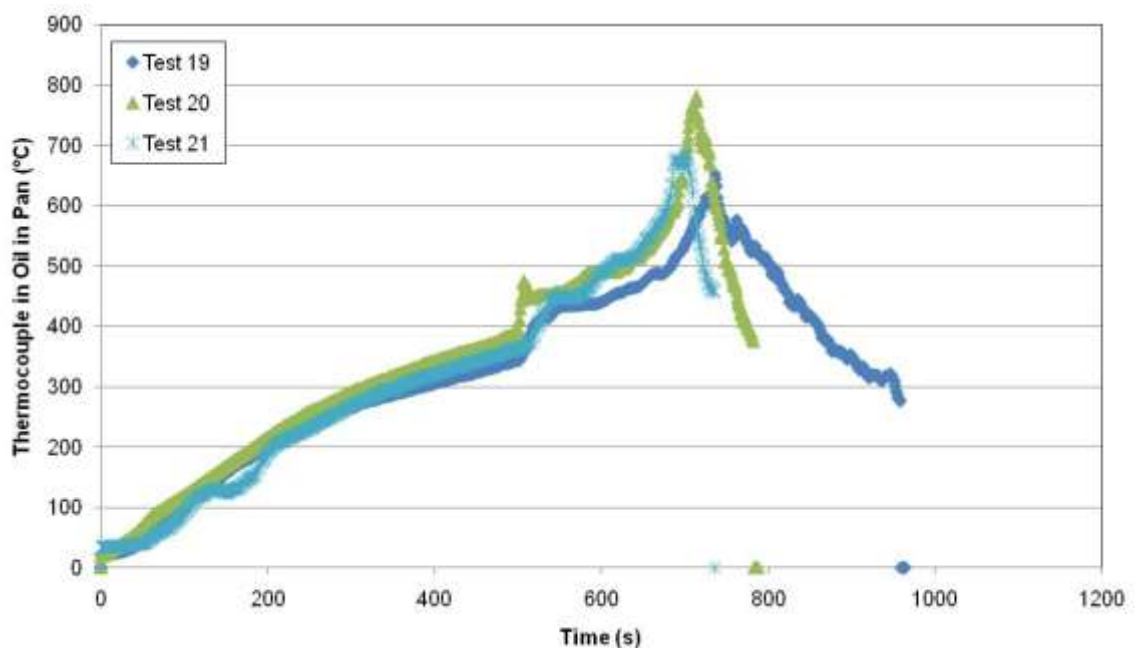

Figure 60: An example of the ratios of each of the variable temperatures to the temperatures at the time of ignition for Test 14.

4.10 Stock Pot with 200 ml Canola Oil, Fan (Tests 19 – 21)

This test was a free-standing electric stove-top under the furniture calorimeter hood with the fan turned on (also allowing data to be collected for the heat release rate). The stock pot, with 200 ml of canola oil, was present on the powered electric element. This test formed a comparison to the results for the setup with a free-standing stove-top and flaming 200 ml canola oil with the extraction fan running (e.g. Section 4.3). Tests 19 to 21 are examples of this scenario.

The thermocouple measurements in the oil and above the centre of the pan are shown in Figure 61. Plate thermometer temperature measurements are shown in Figure 62. Thermocouple measurements for locations on the surface of the stove-top are shown in Figure 63. Heat release rates based on oxygen calorimetry are shown in Figure 64. Estimates of the incident radiation on the plate thermometers are shown in Figure 65. An example of the temperature differences between sequential time steps for each of the variables recorded is shown in Figure 66 for Test 19 (where the time shown is based on the original test data, as included in Appendices C and D). An example of the ratios of temperatures to the temperature at the time of ignition for each of the variables recorded is shown in Figure 67 for Test 19 (where the time shown is based on the original test data, as included in Appendices C and D). In this case, because the stock pot had such high sides, the thermocouple located 100 mm above the centre of the element was pushed to one side, so it was touching the side of the stockpot at 100 mm above the heating element. Therefore a difference compared to the other vessels for this experimental variable is expected.



(a)

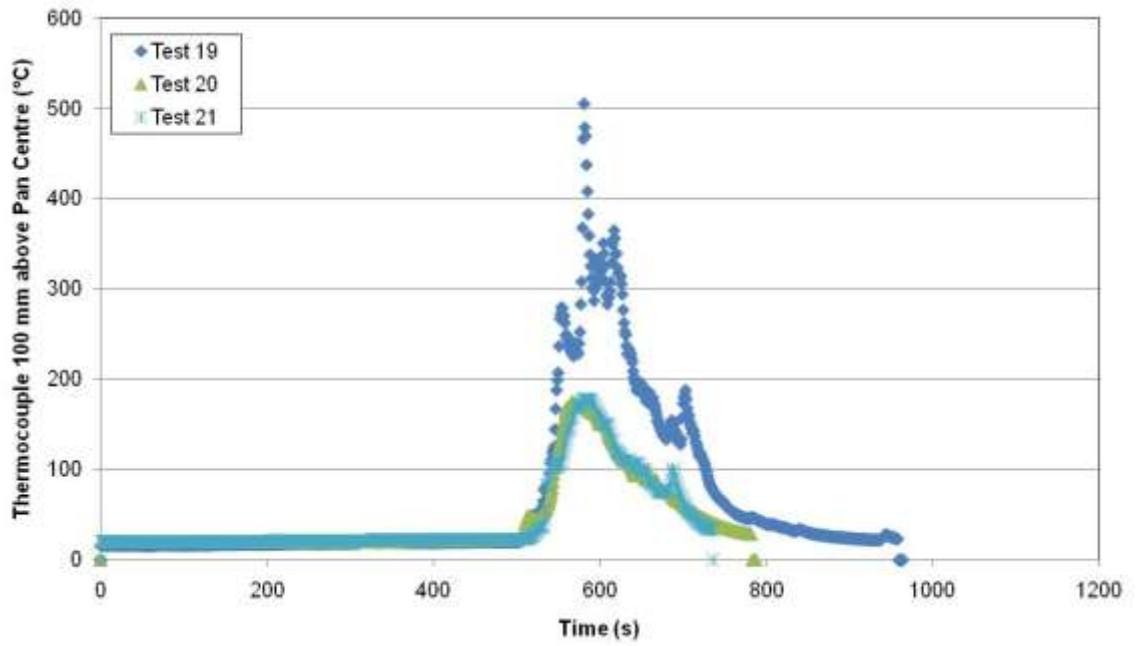

(b)

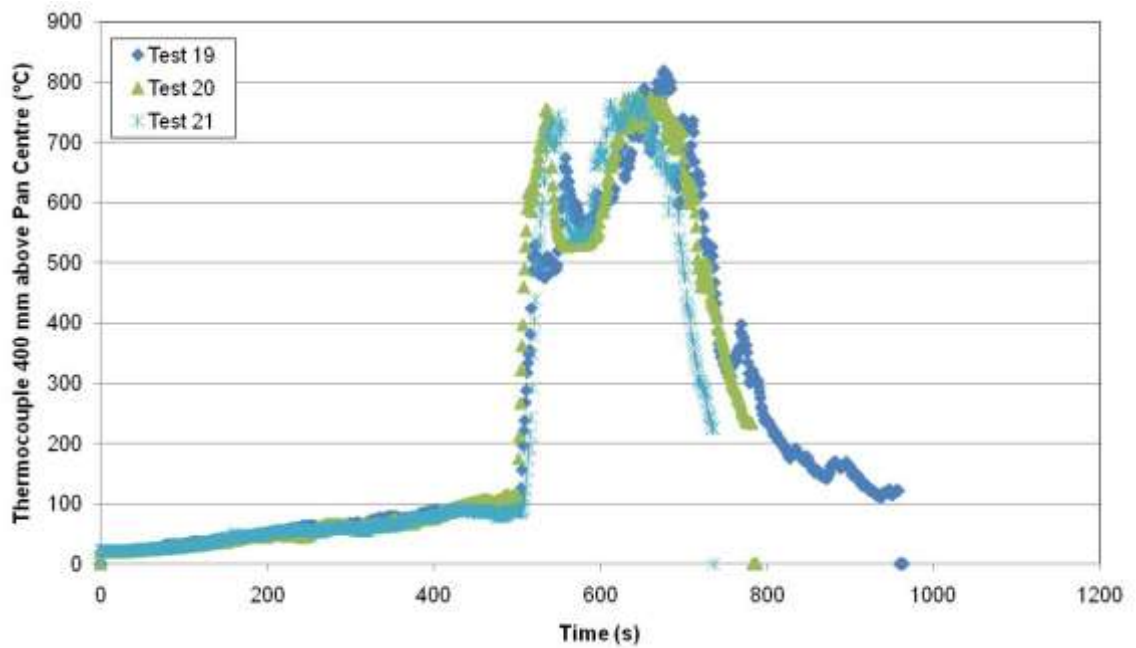

(c)

Figure 61: Thermocouple measurements for the thermocouple located (a) in the oil in the stock pot, (b) 100 mm above the centre of the skillet, and (c) 400 mm above the centre of the stock pot for Tests 19 – 21.

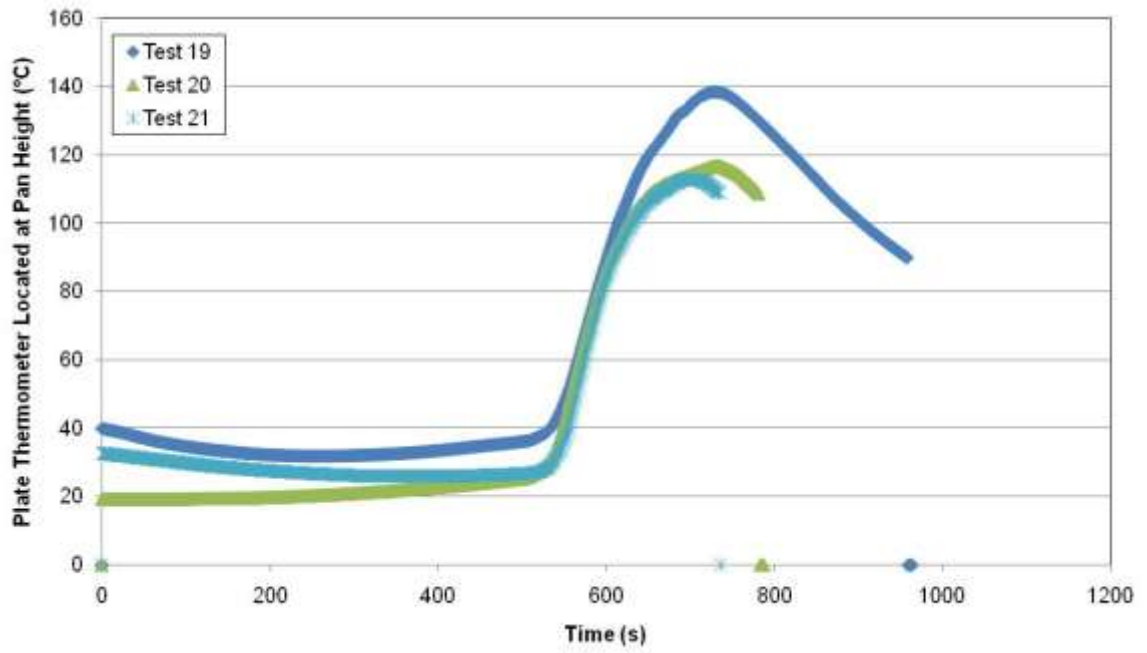

(a)

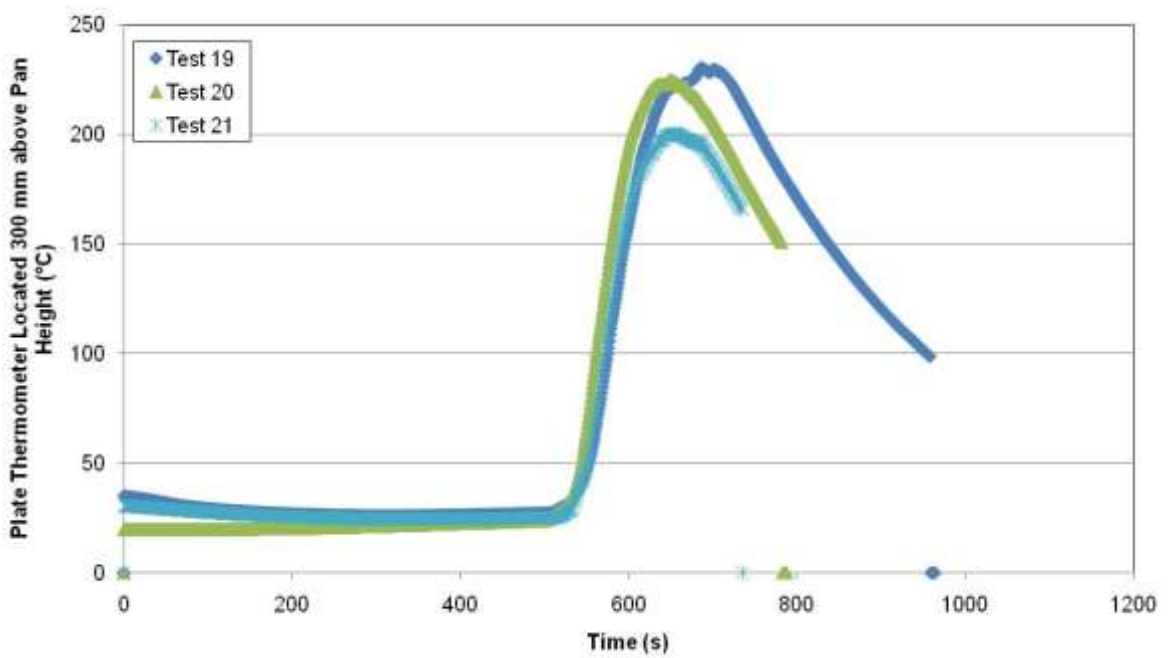

(b)

Figure 62: Plate thermometer temperature measurements for (a) 50 mm above the surface of the stove-top, and (b) 350 mm above the surface of the stove-top for Tests 19 – 21.

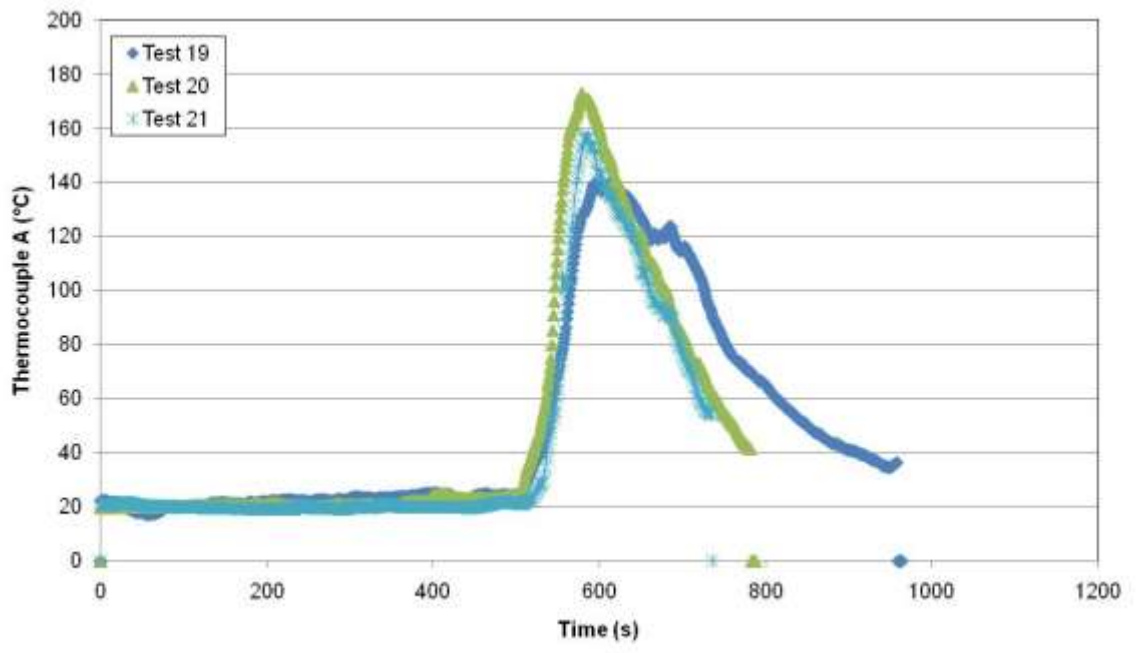

(a)

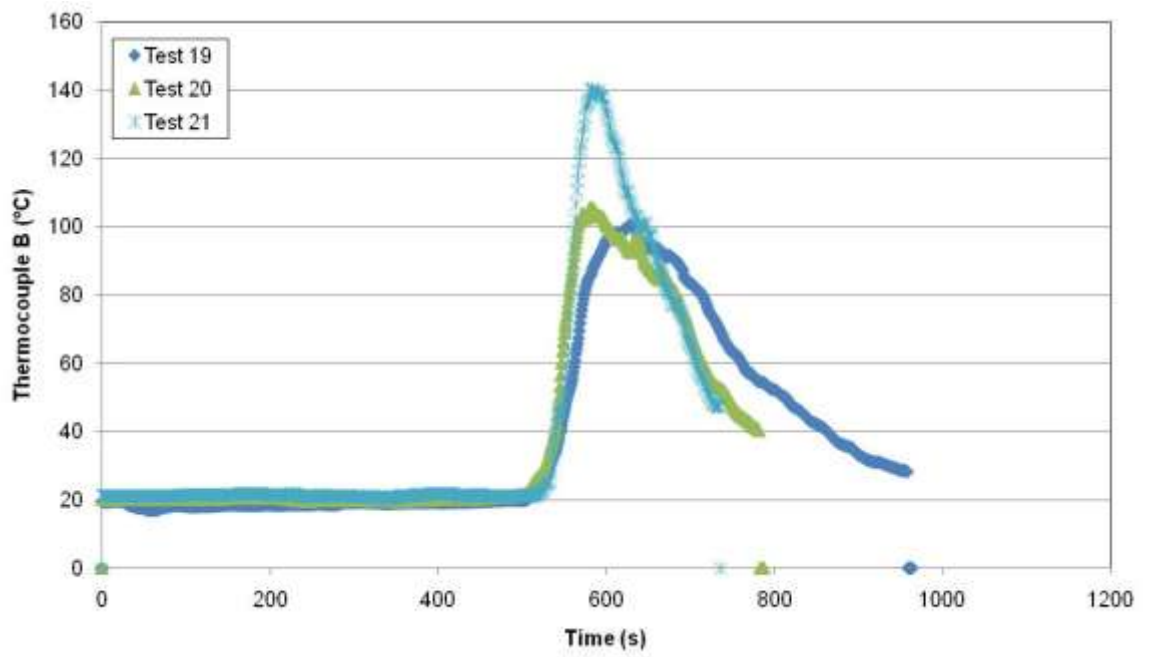

(b)

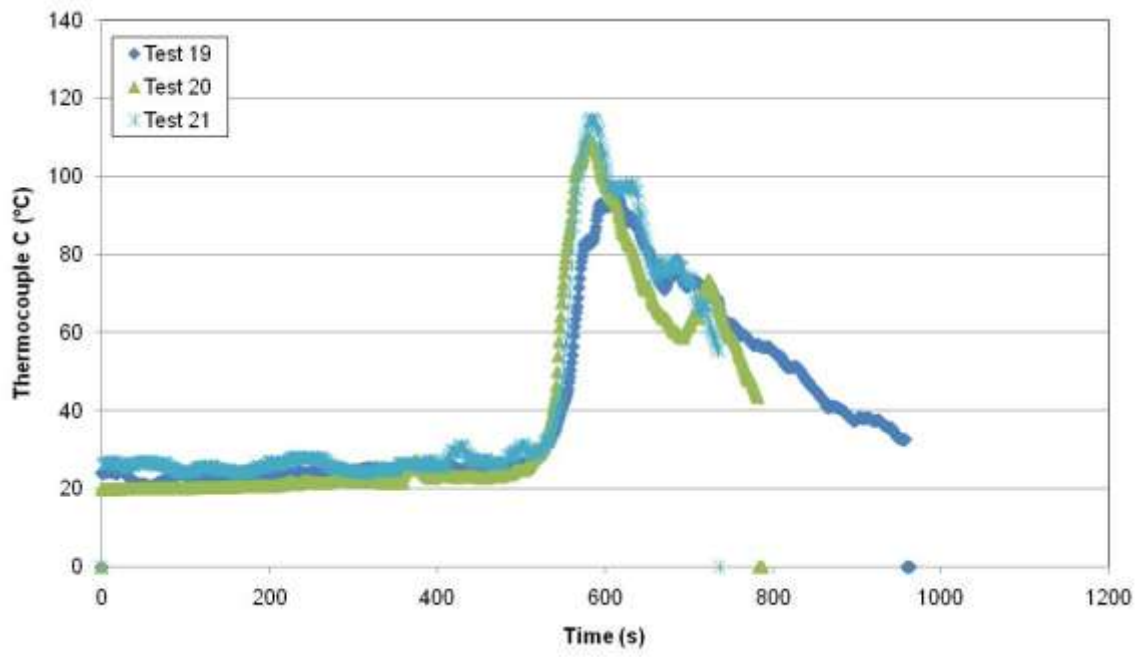

(c)

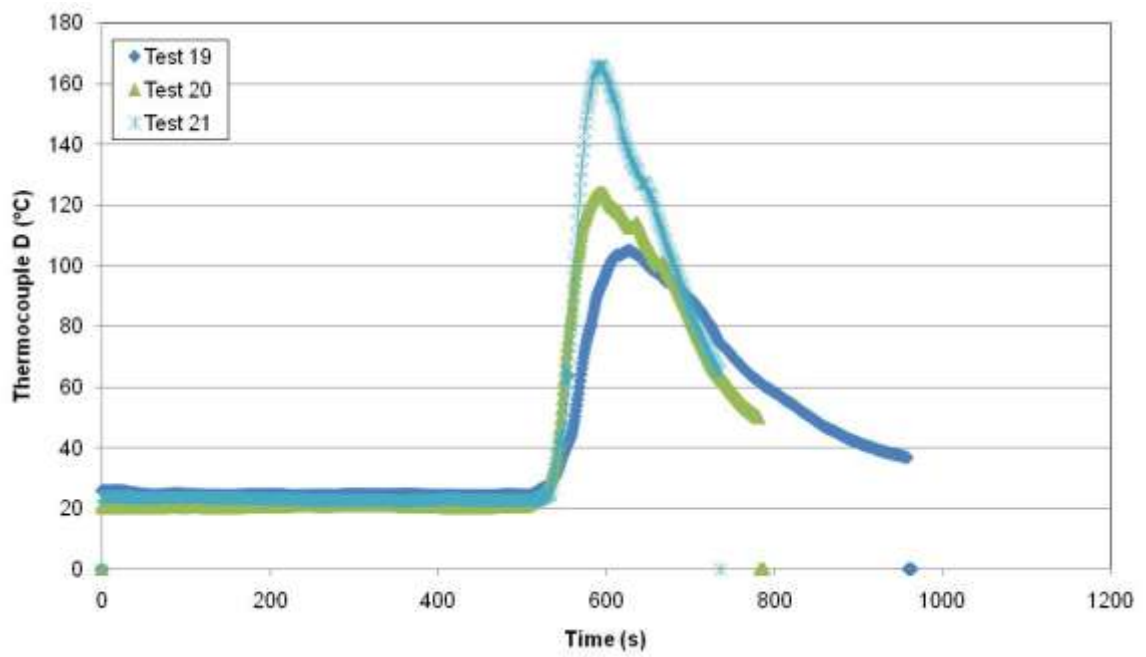

(d)

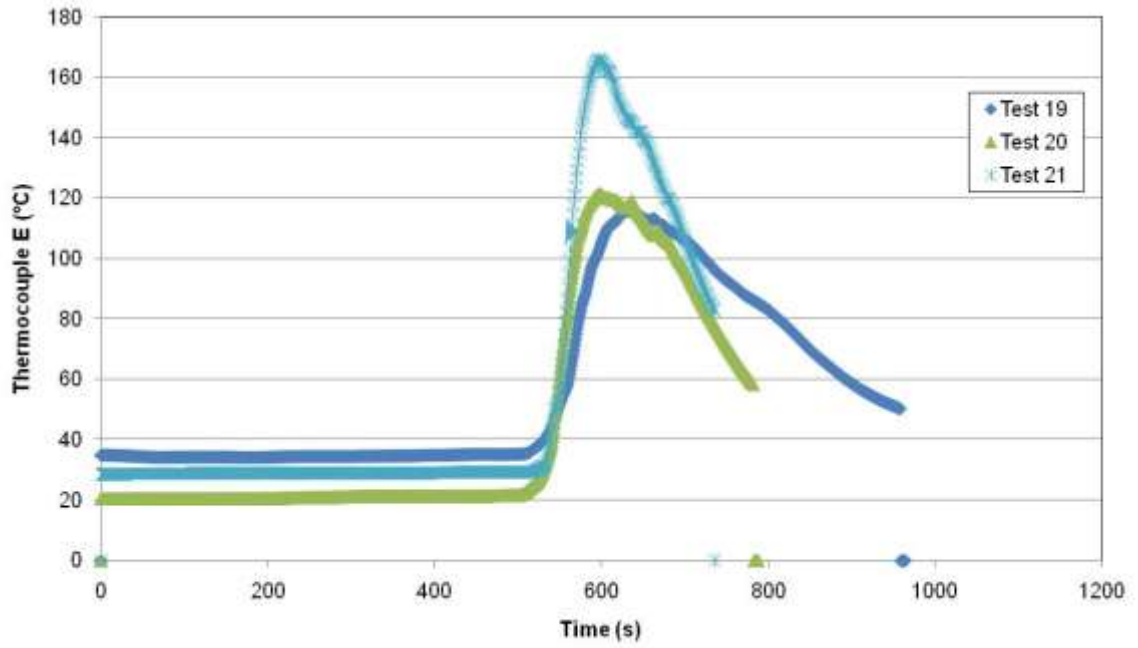

(e)

Figure 63: Thermocouple measurements of (a) thermocouple A, (b) thermocouple B, (c) thermocouple C, (d) thermocouple D, and (e) thermocouple E for Tests 19 – 21.

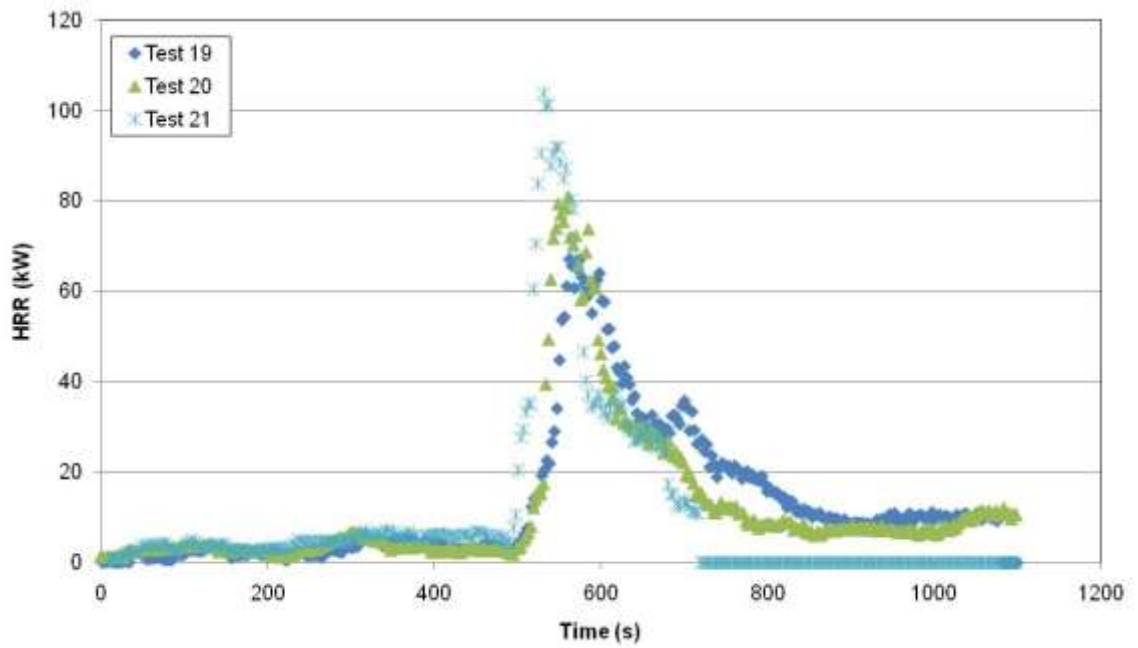
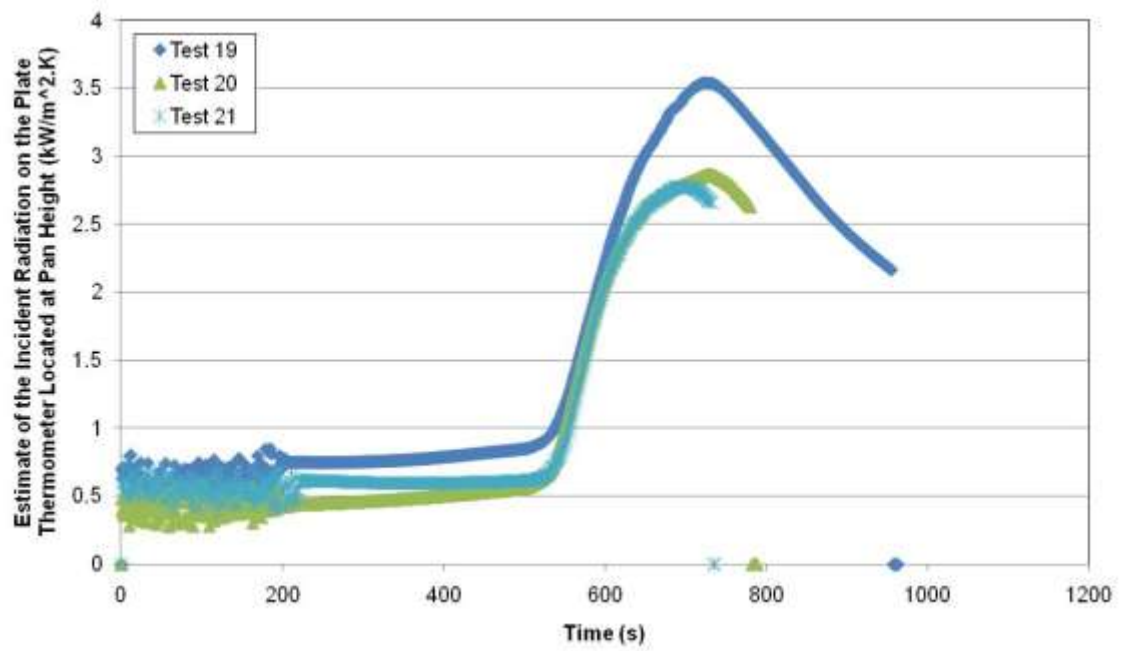
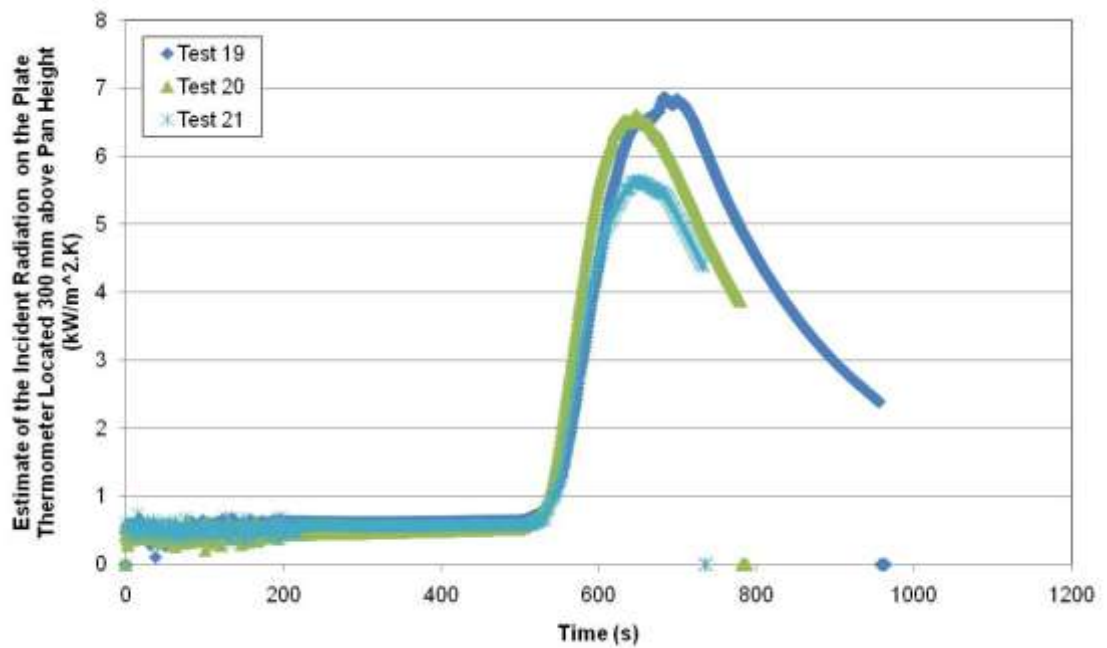

Figure 64: Heat release rates estimated from oxygen calorimetry for Tests 19 – 21.

4.10.1 Analysis



(a)



(b)

Figure 65: Estimates of the incident radiation on the plate thermometer (a) 50 mm and (b) 350 mm above the surface of the stove-top for Tests 19 – 21.

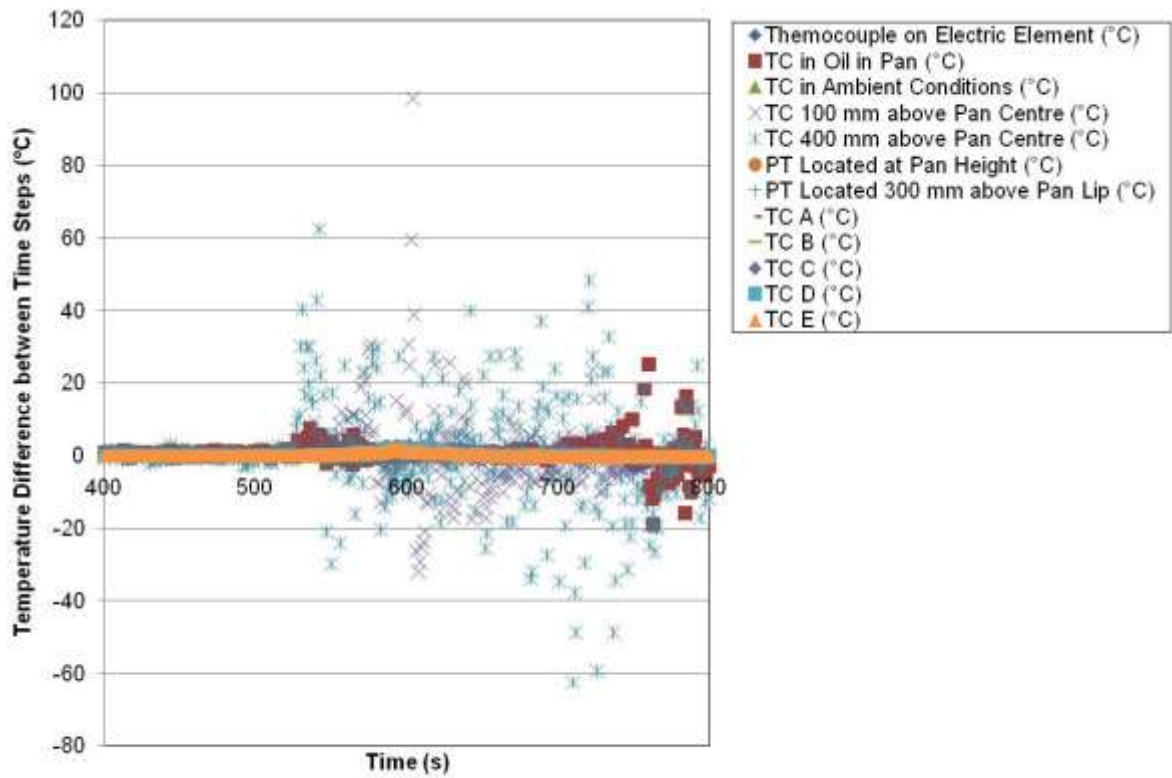

Figure 66: Examples of differences of each of the variable temperatures to between sequential time steps for Test 19.

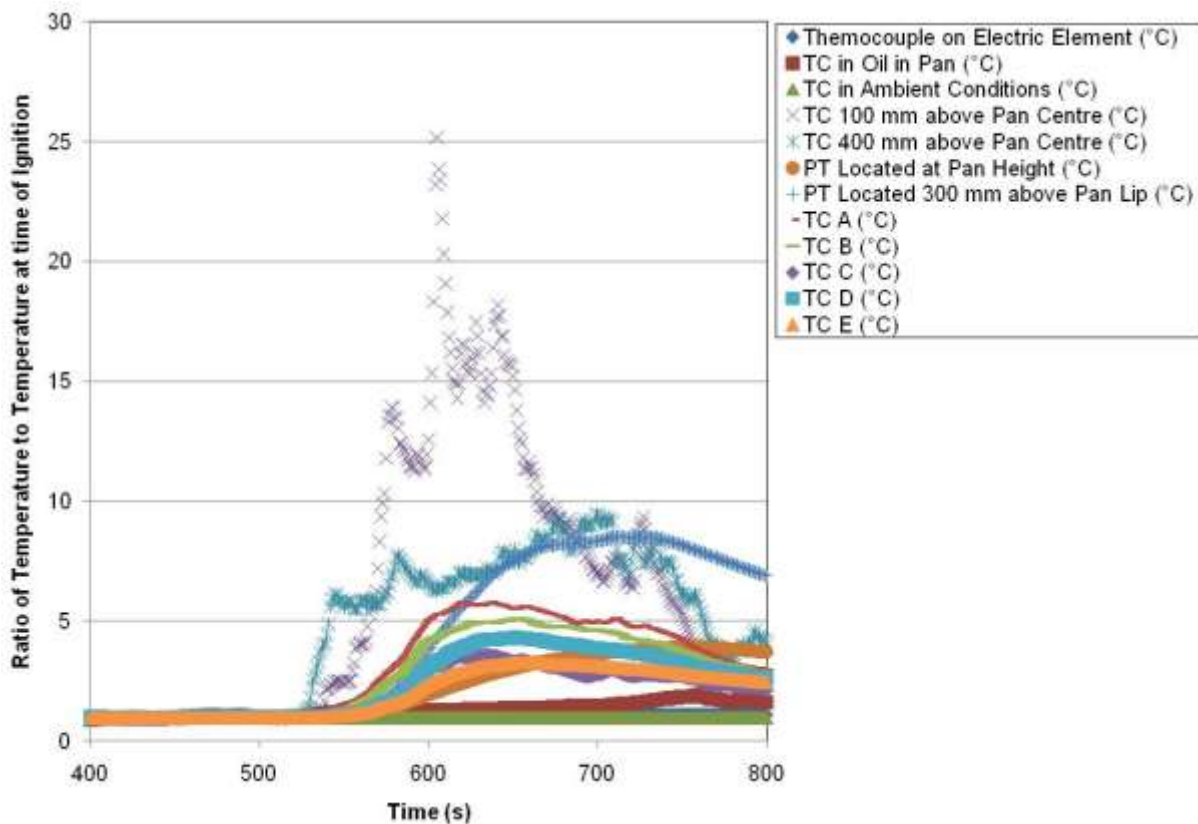
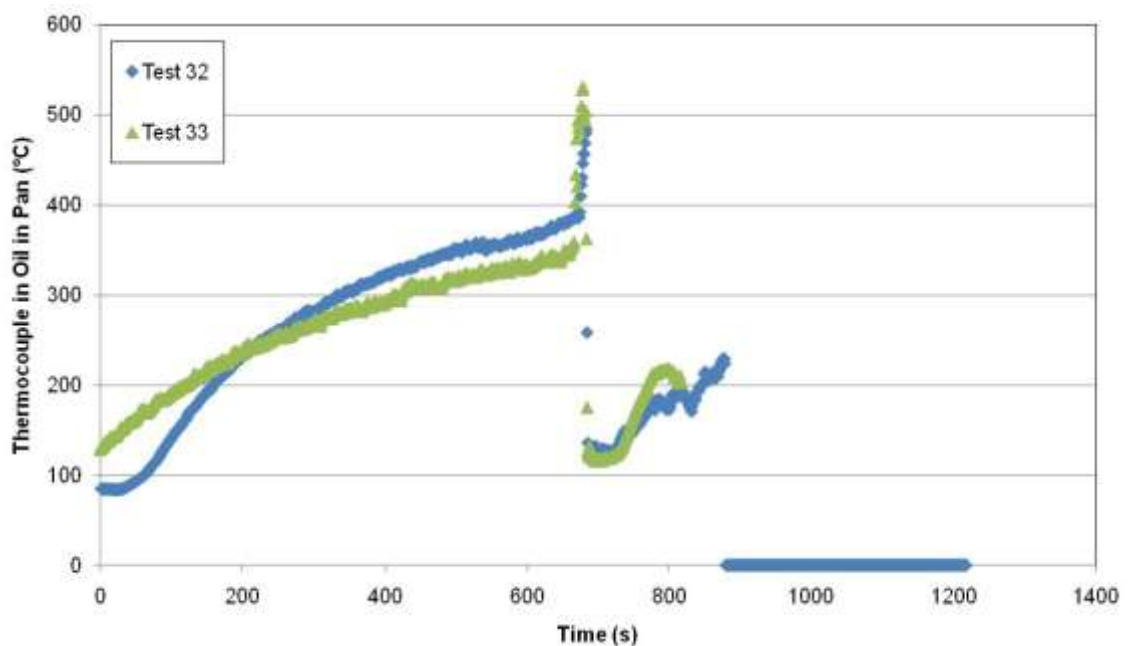

Figure 67: Examples of ratios of each of the variable temperatures to the temperatures at the time of ignition for Test 19.

4.11 Skillet with 200 ml Canola Oil, Fan, 200 ml Water Added after Ignition (Tests 32 & 33)

This test was a free-standing electric stove-top under the furniture calorimeter hood with the fan turned on. The skillet, containing 200 ml of canola oil, was present on the powered electric element. Within 10 s after ignition was observed, 200 ml of water was poured into the flaming oil. Tests 32 and 33 were examples of this situation and provided a comparison to the tests where cooking oil with a small amount of water was present within the cooking vessel from the beginning as well as the sprinkler protected tests.

The thermocouple measurements in the oil and above the centre of the pan are shown in Figure 68. Plate thermometer temperature measurements are shown in Figure 69. Thermocouple measurements from the locations on the surface of the stove-top are shown in Figure 70. Estimates of the heat release rate based on oxygen calorimetry are shown in Figure 71. Estimates of the incident radiation on the plate thermometers are shown in Figure 72. An example of the temperature differences between sequential time steps for each of the variables recorded is shown in Figure 73 for Test 33 (where the time shown is based on the original test data, as included in Appendices C and D). An example of the ratios of temperatures to the temperature at the time of ignition for each of the variables recorded is shown in Figure 74 for Test 33 (where the time shown is based on the original test data, as included in Appendices C and D).



(a)

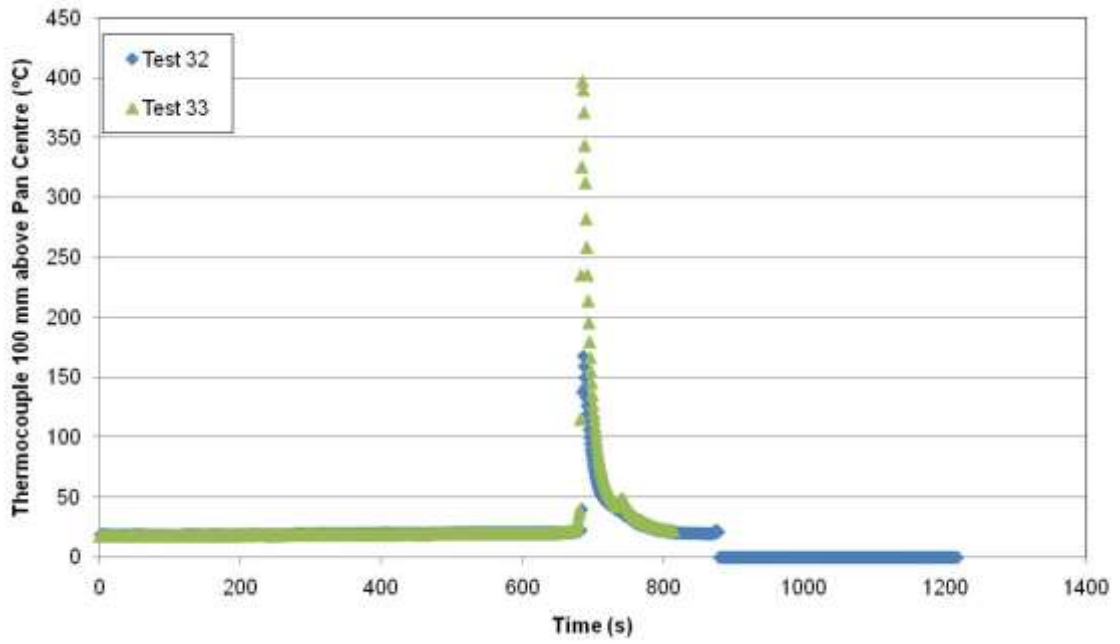

(b)

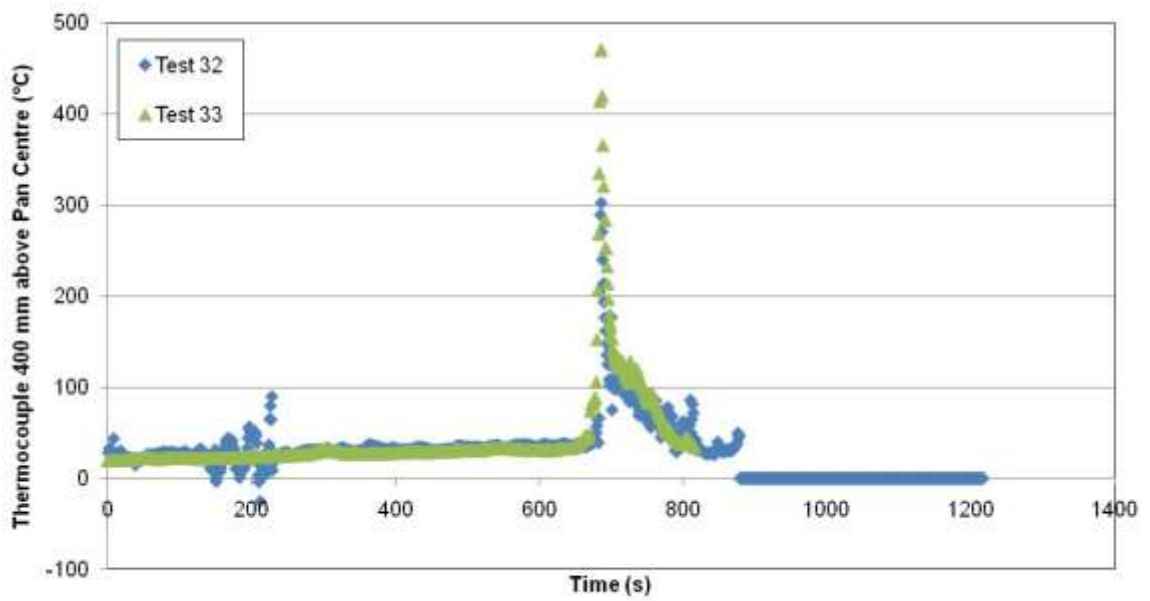

(c)

Figure 68: Thermocouple measurements for the thermocouple located (a) in the oil in the skillet, (b) 100 mm above the centre of the skillet, and (c) 400 mm above the centre of the skillet for Tests 32 and 33.

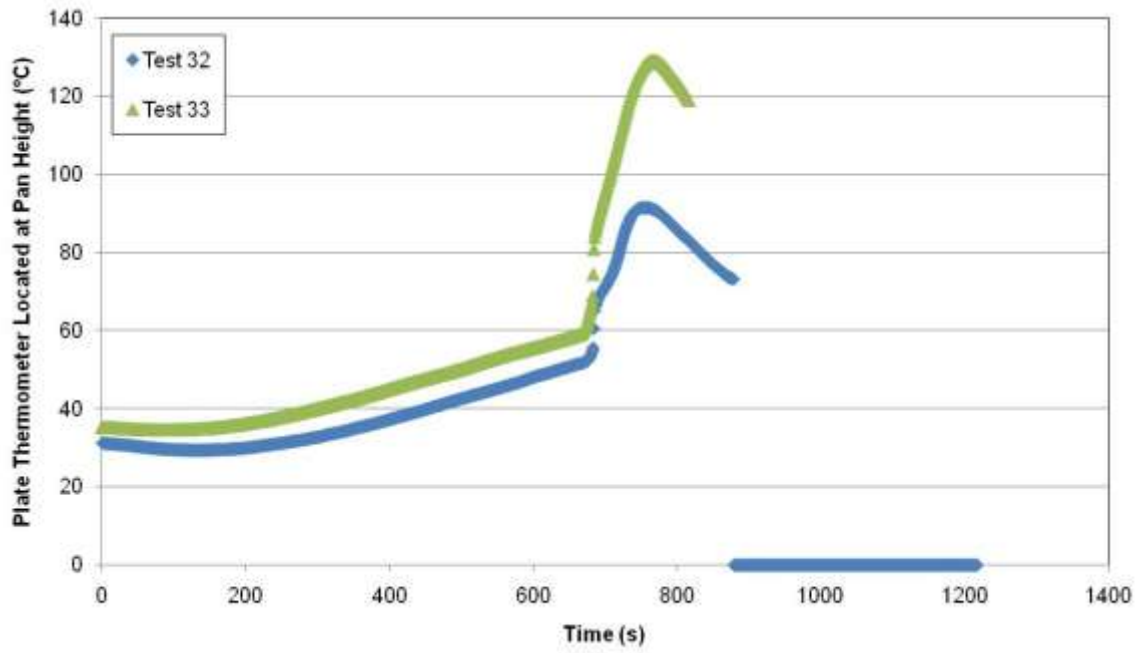

(a)

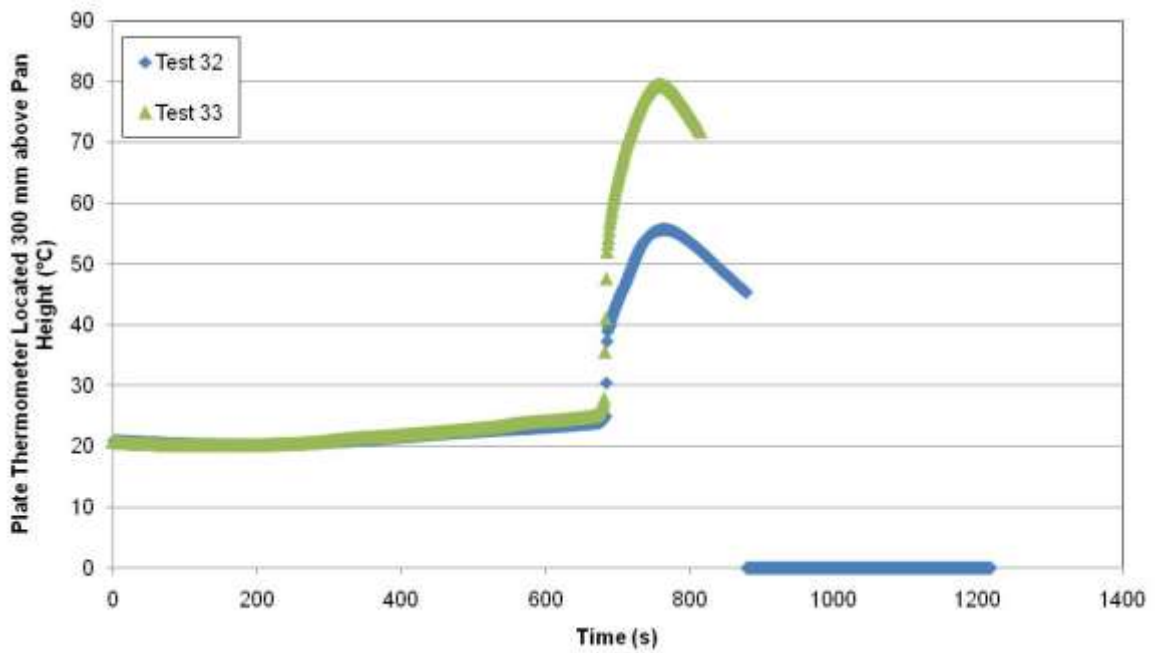

(b)

Figure 69: Plate thermometer temperature measurements for (a) at the height of the lip of the skillet, and (b) 300 mm above the lip of the skillet for Tests 32 and 33.

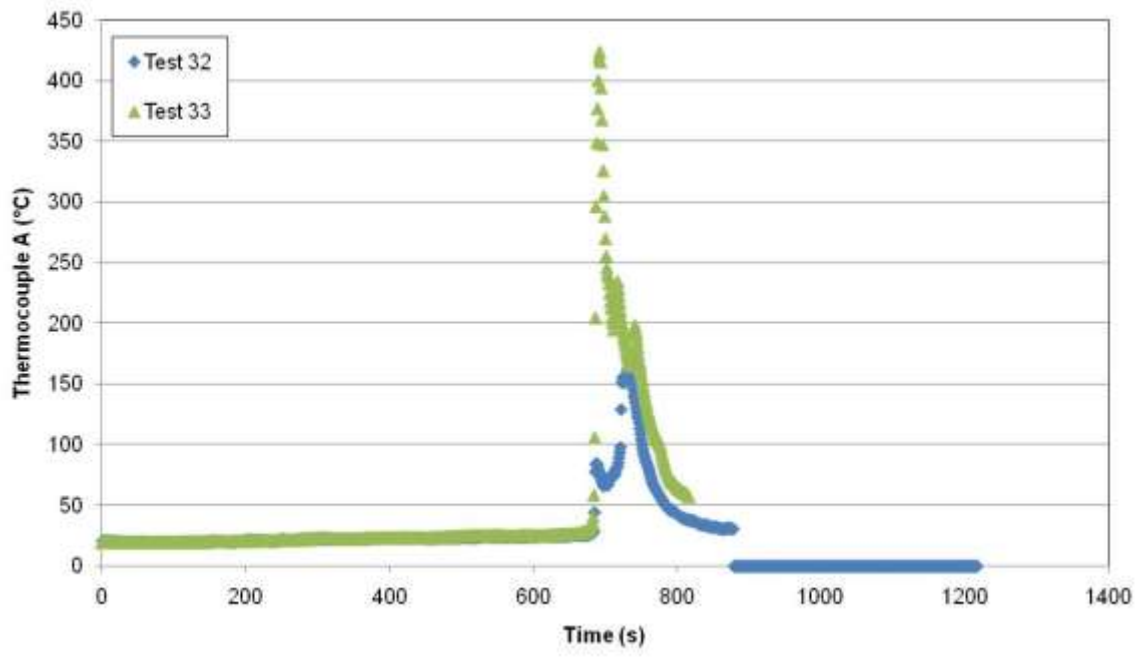

(a)

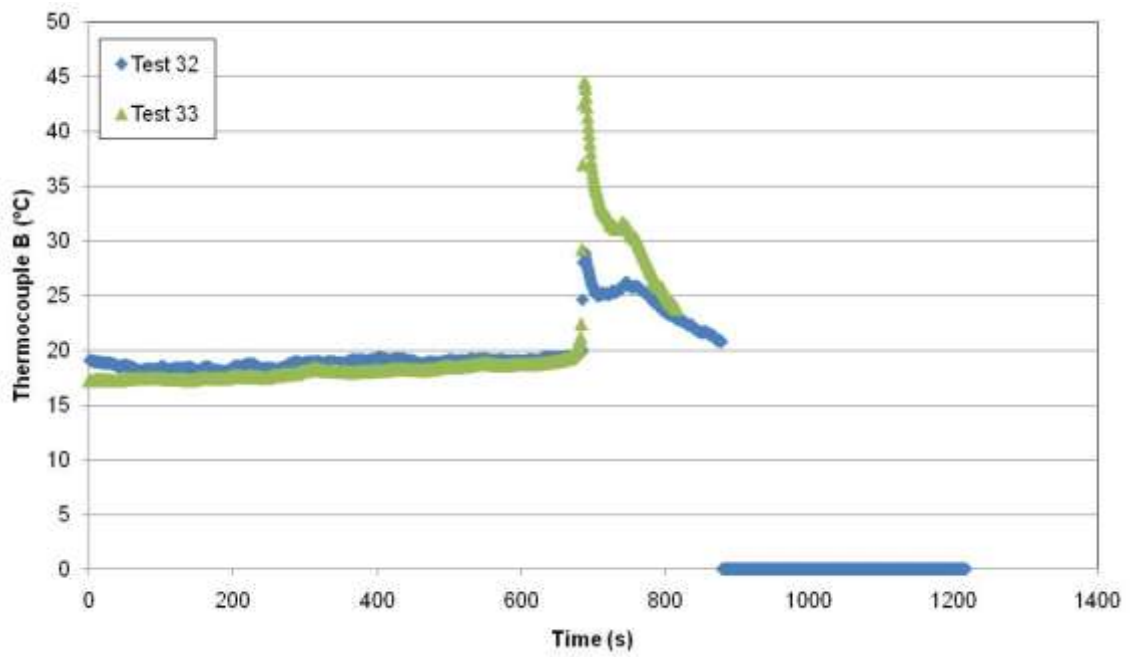

(b)

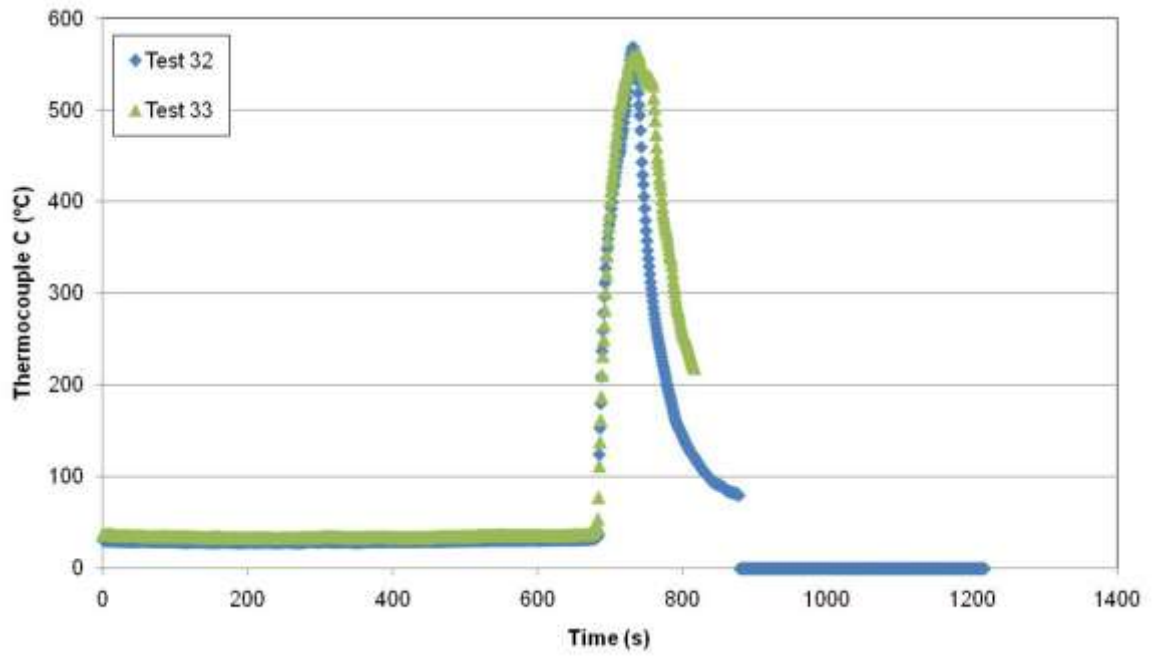

(c)

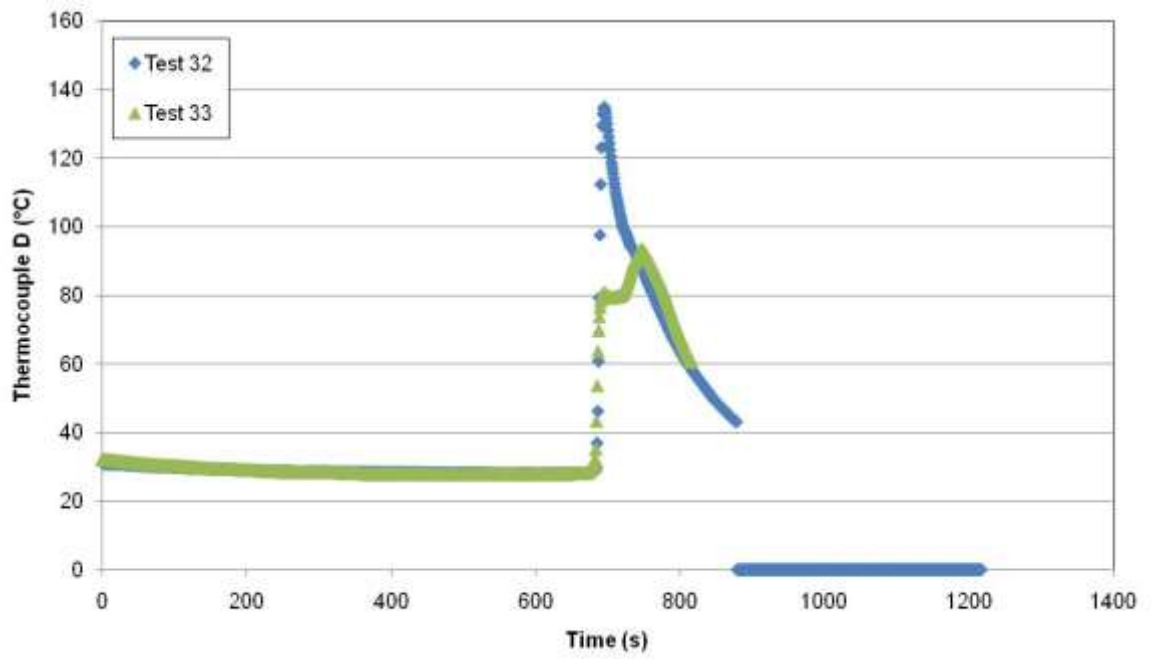

(d)

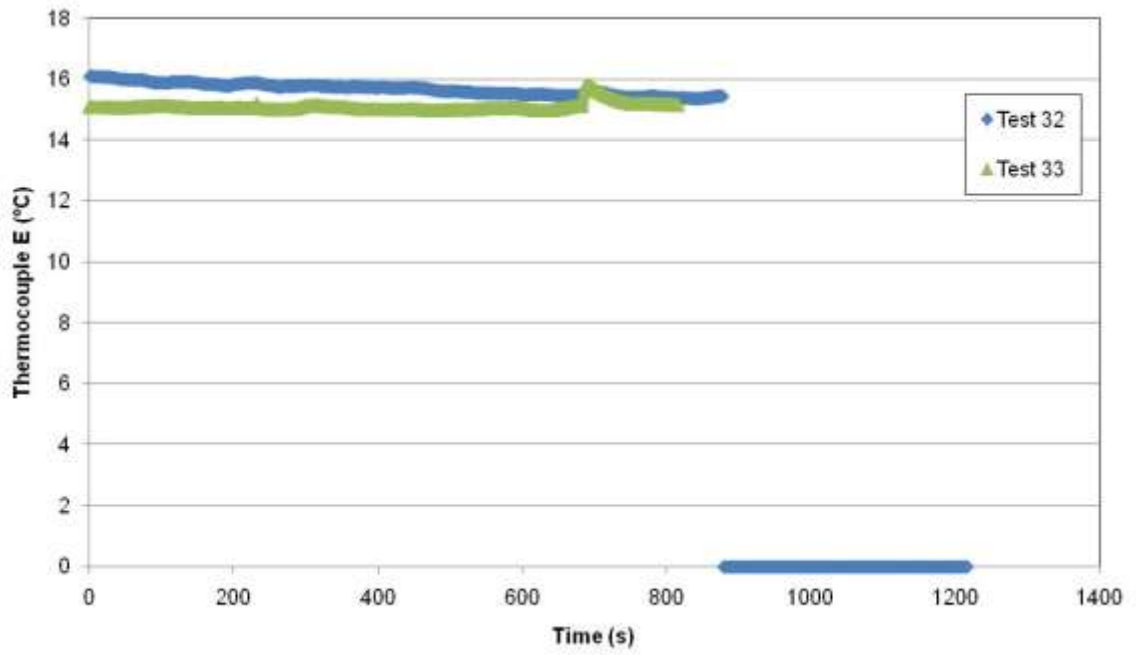

(e)

Figure 70: Thermocouple measurements of (a) thermocouple A, (b) thermocouple B, (c) thermocouple C, (d) thermocouple D, and (e) thermocouple E for Tests 32 and 33.

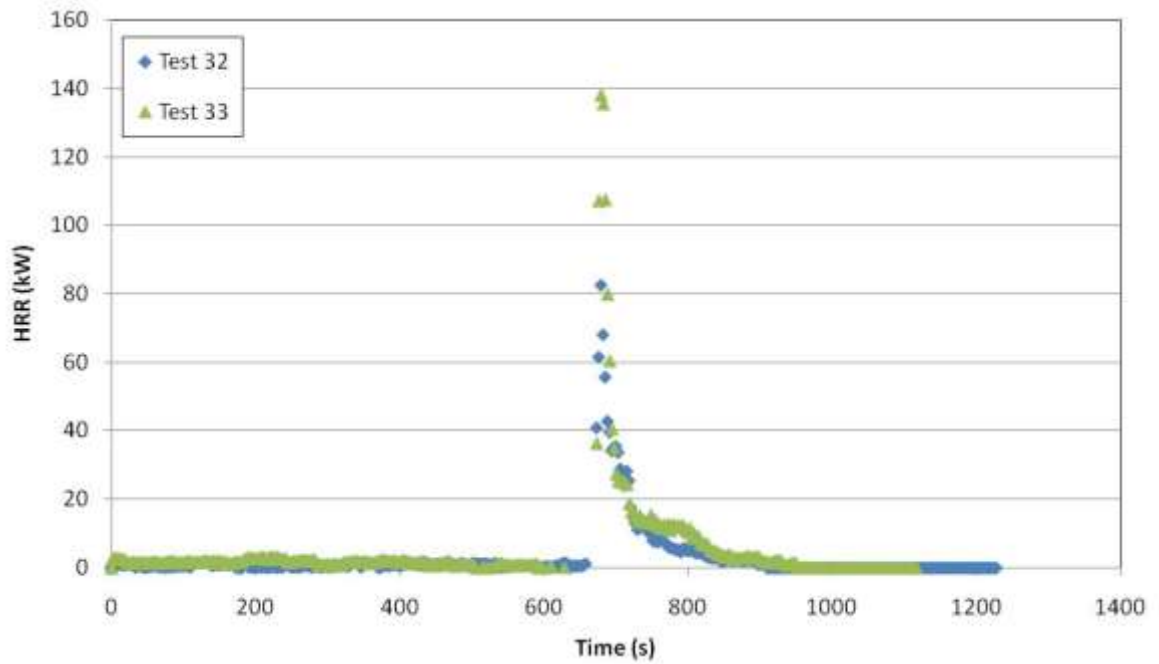
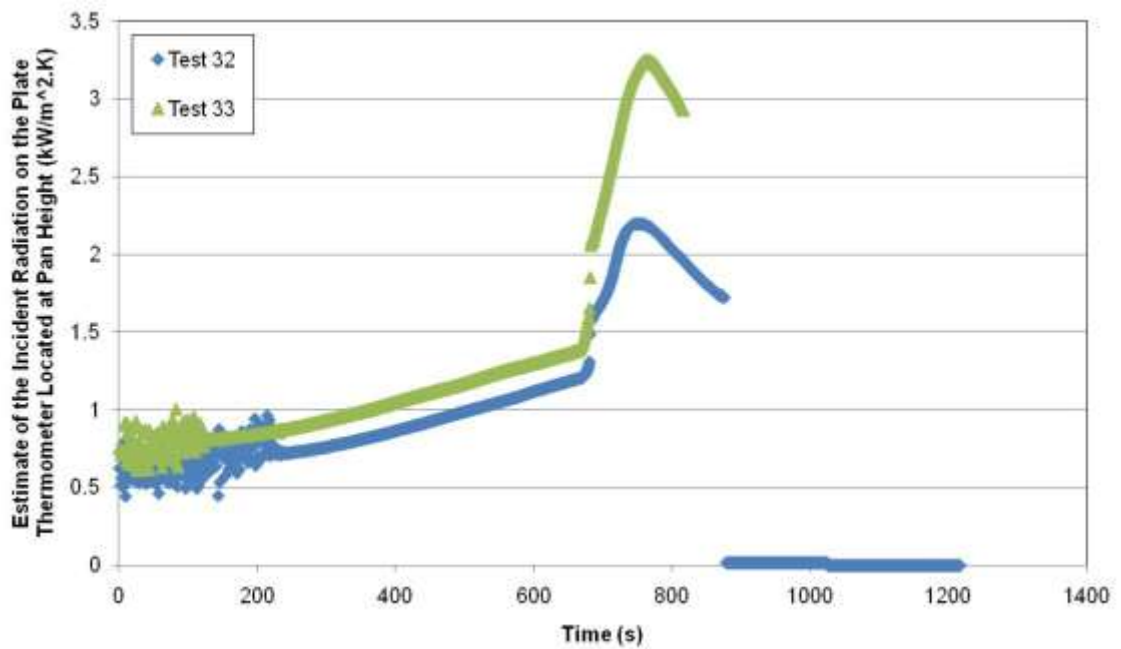
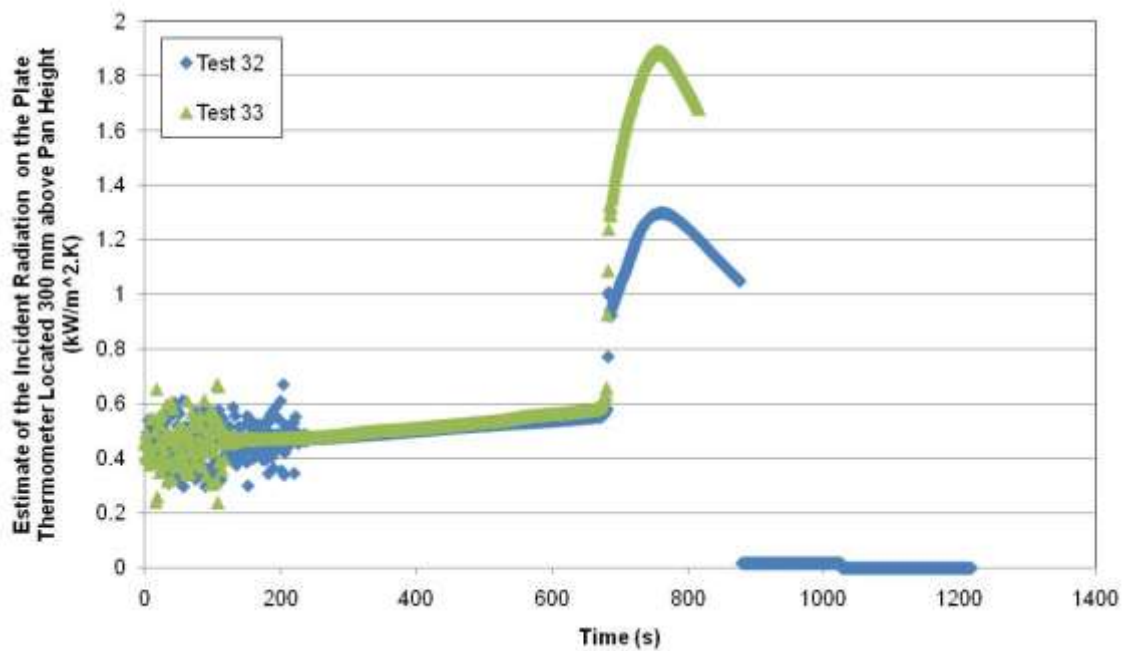

Figure 71: Heat release rates estimated from oxygen calorimetry for Tests 32 and 33.

4.11.1 Analysis



(a)



(b)

Figure 72: Estimates of the incident radiation on the plate thermometer (a) at the height of the lip of the skillet, and (b) 300 mm above the lip of the skillet.

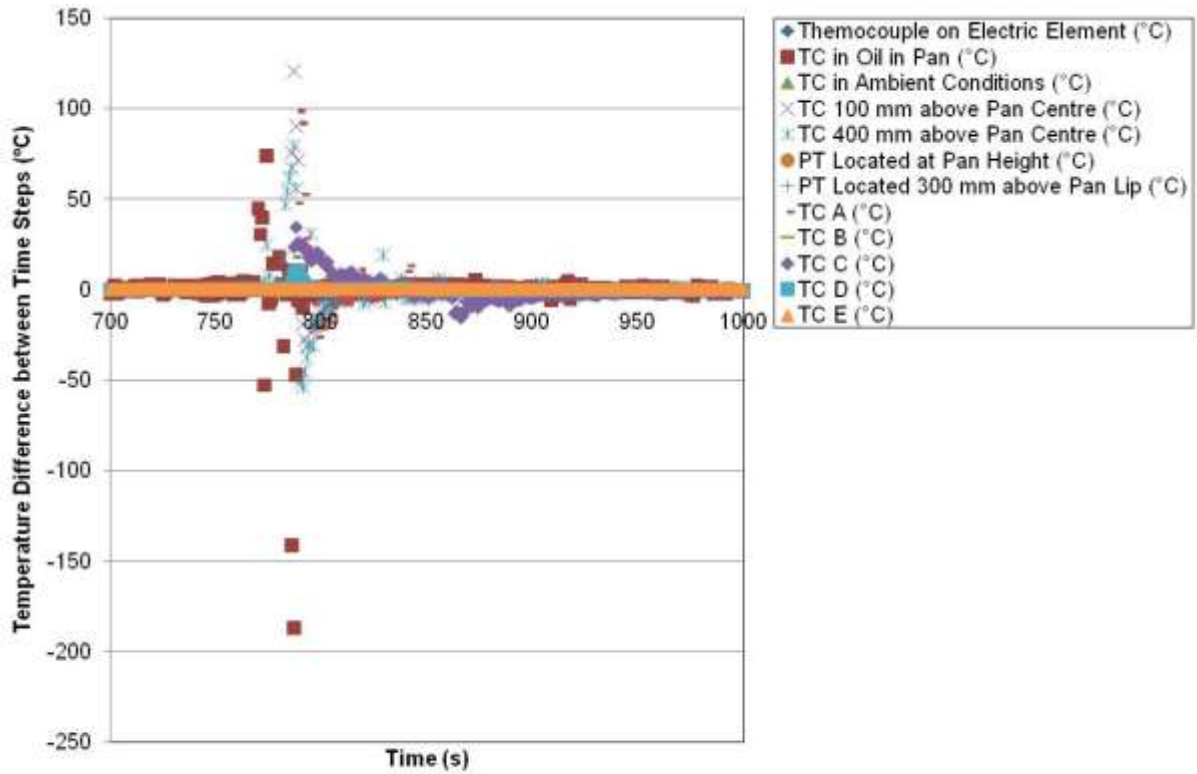

Figure 73: Examples of the differences of each of the variable temperatures to between sequential time steps for Test 33.

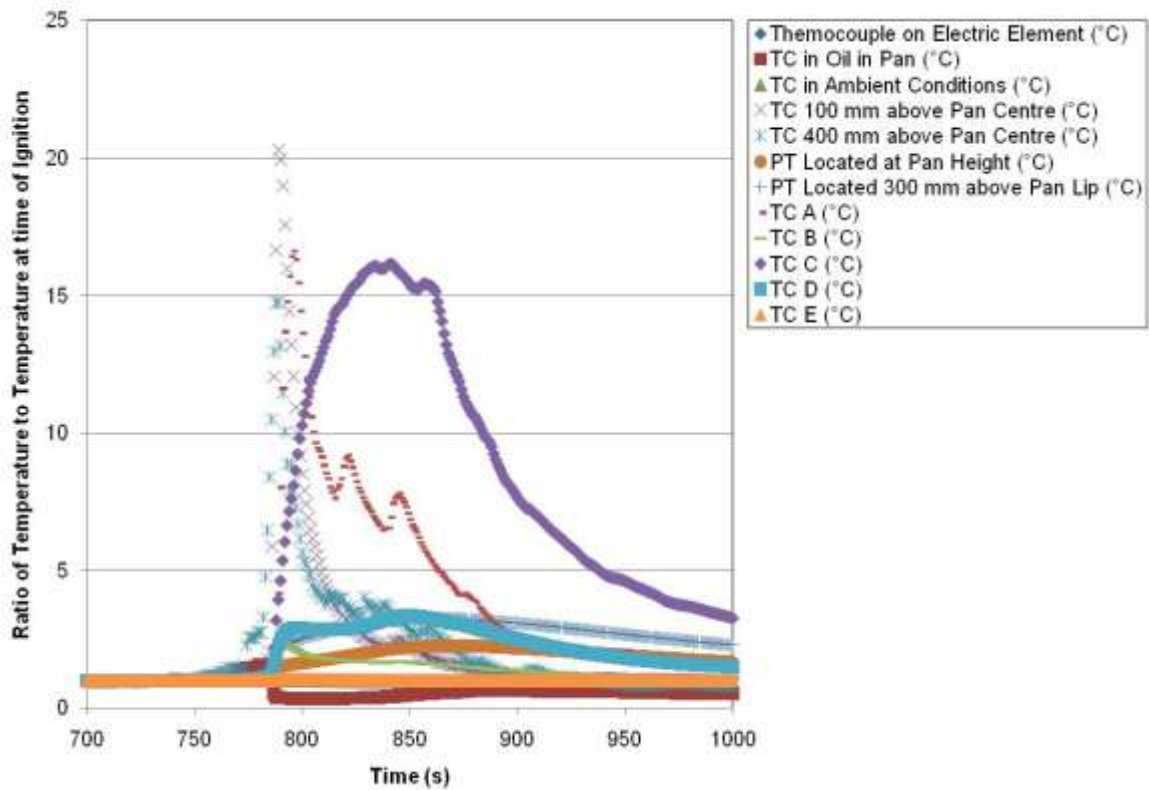

Figure 74: Examples of the ratios of each of the variable temperatures to the temperatures at the time of ignition for Test 33.

4.12 Skillet with 200 ml Canola Oil, Fan, Heating Element De-energized After Ignition (Tests 35 & 37)

This test was a free-standing electric stove-top under the furniture calorimeter hood with the fan turned on (also allowing data to be collected for the heat release rate) where the heating element was de-energized within 10 s of the first observations of flames. The skillet, with 200 ml of canola oil, was present on the powered electric element. This test formed a comparison to the results for the setup with a free-standing stove-top and flaming 200 ml canola oil with the extraction fan running (e.g. Section 4.3) and tests where types of fire suppression were applied (e.g. Sections 4.13 - 4.17). Tests 35 and 37 are examples of this scenario.

Thermocouple measurements on the surface between the heating element and the bottom of the skillet are shown in Figure 75. The thermocouple measurements in the oil and above the centre of the pan are shown in Figure 76. Plate thermometer temperature measurements are shown in Figure 77. Thermocouple measurements for locations on the surface of the stove-top are shown in Figure 78. Heat release rates based on oxygen calorimetry are shown in Figure 79. Estimates of the incident radiation on the plate thermometers are shown in Figure 80. An example of the temperature differences between sequential time steps for each of the variables recorded is shown in Figure 81 for Test 37 (where the time shown is based on the original test data, as included in Appendices C and D). An example of the ratios of temperatures to the temperature at the time of ignition for each of the variables recorded is shown in Figure 82 for Test 37 (where the time shown is based on the original test data, as included in Appendices C and D).

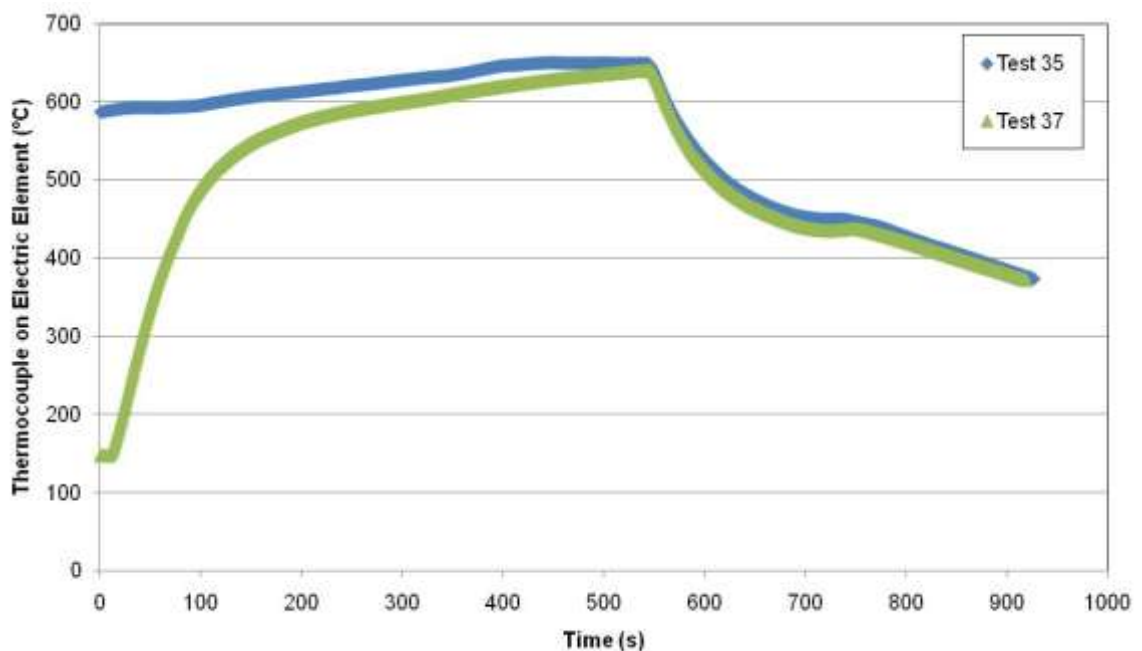
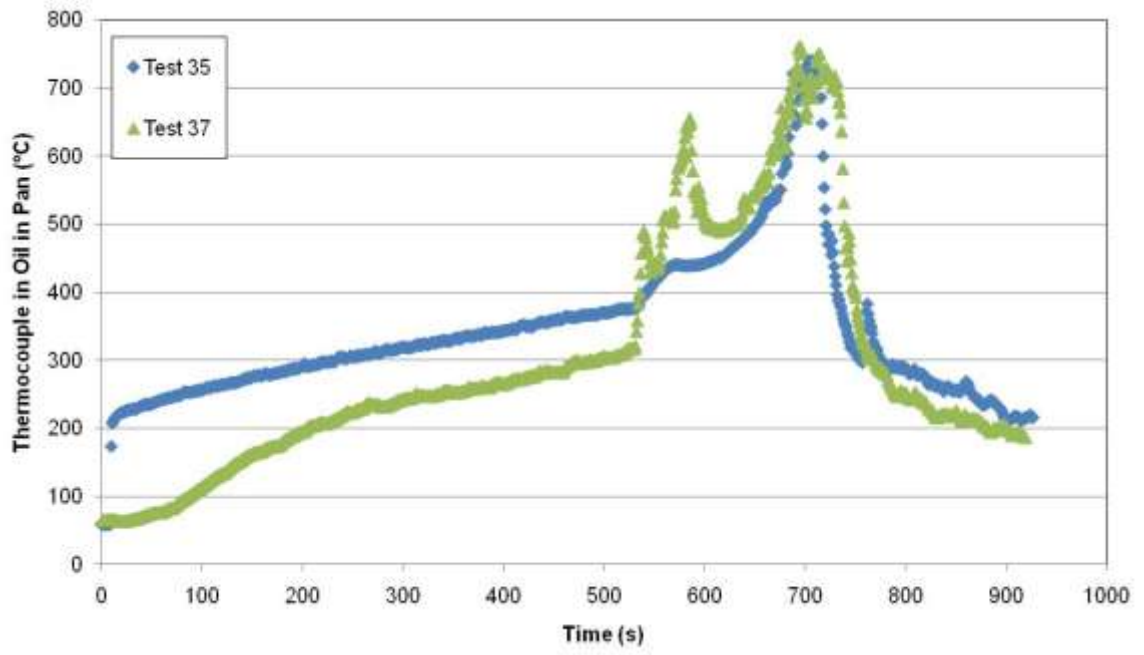
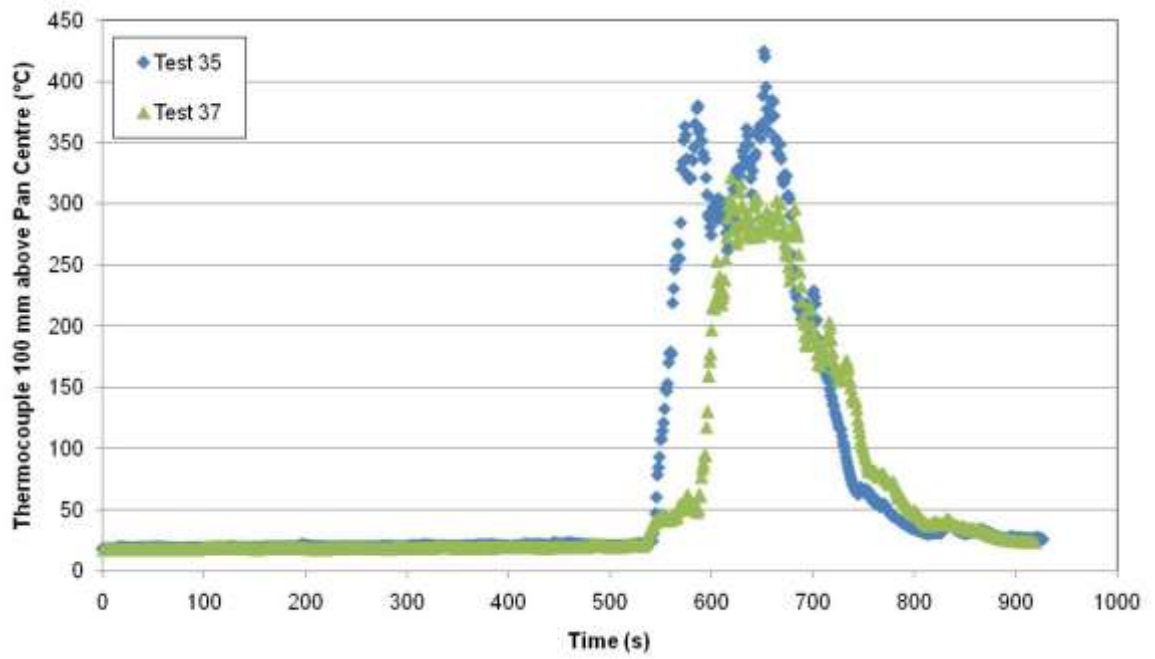

Figure 75: Thermocouple measurements for the thermocouple located on the electric element for Tests 35 and 37.



(a)



(b)

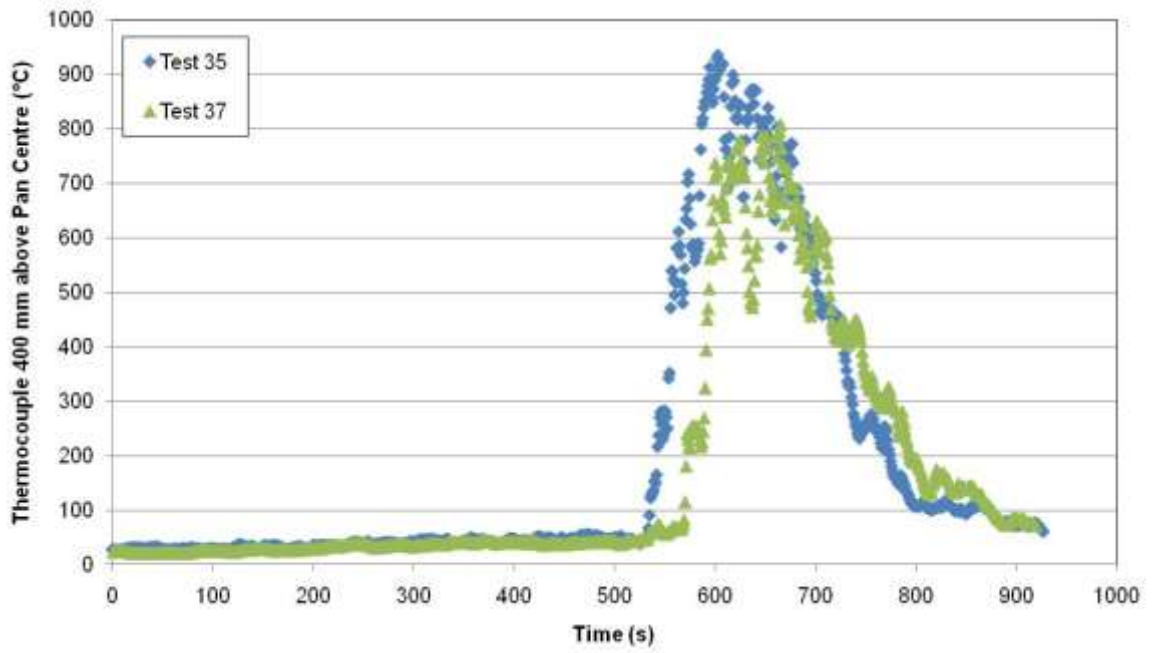

(c)

Figure 76: Thermocouple measurements for the thermocouple located (a) in the oil in the skillet, (b) 100 mm above the centre of the skillet, and (c) 400 mm above the centre of the skillet for Tests 35 and 37.

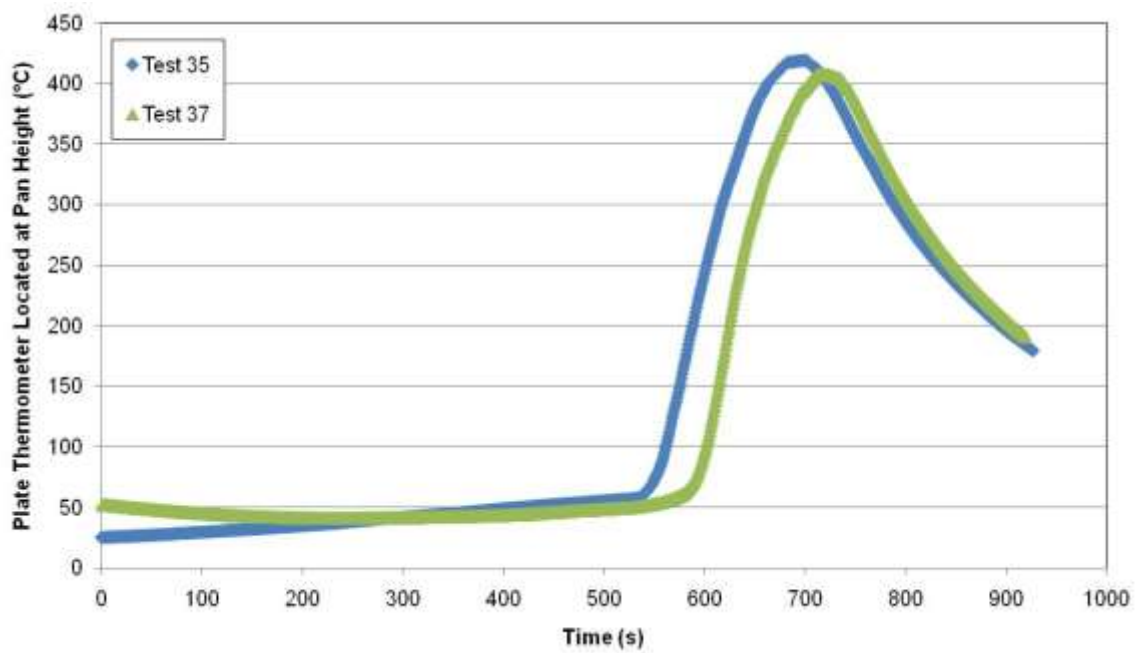

(a)

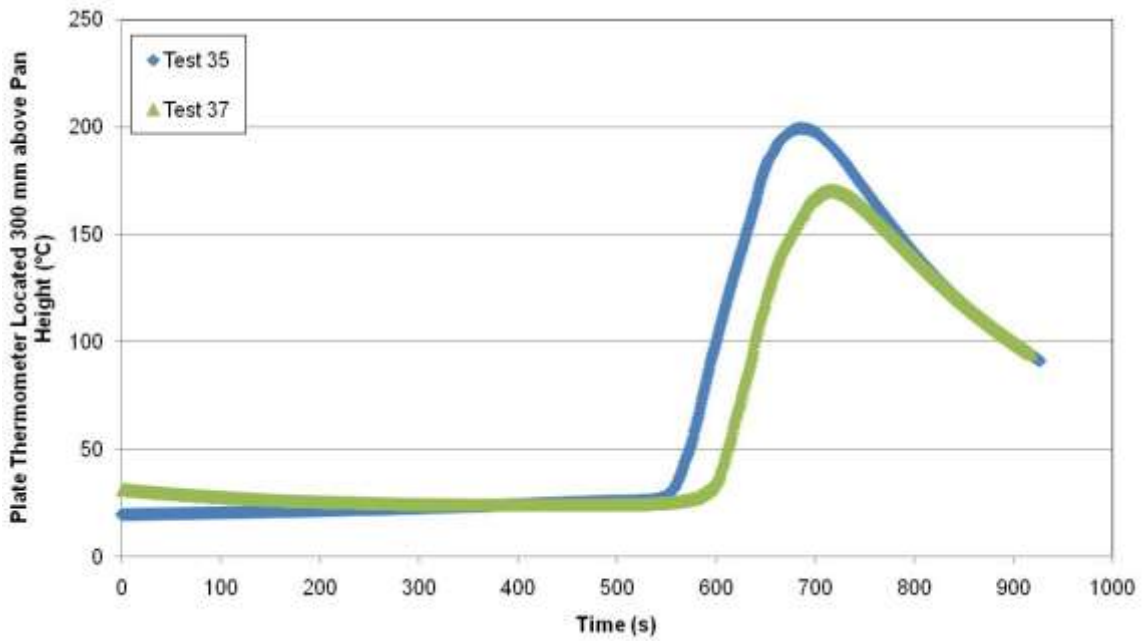

(b)

Figure 77: Plate thermometer temperature measurements for (a) at the height of the lip of the skillet, and (b) 300 mm above the lip of the skillet for Tests 35 and 37.

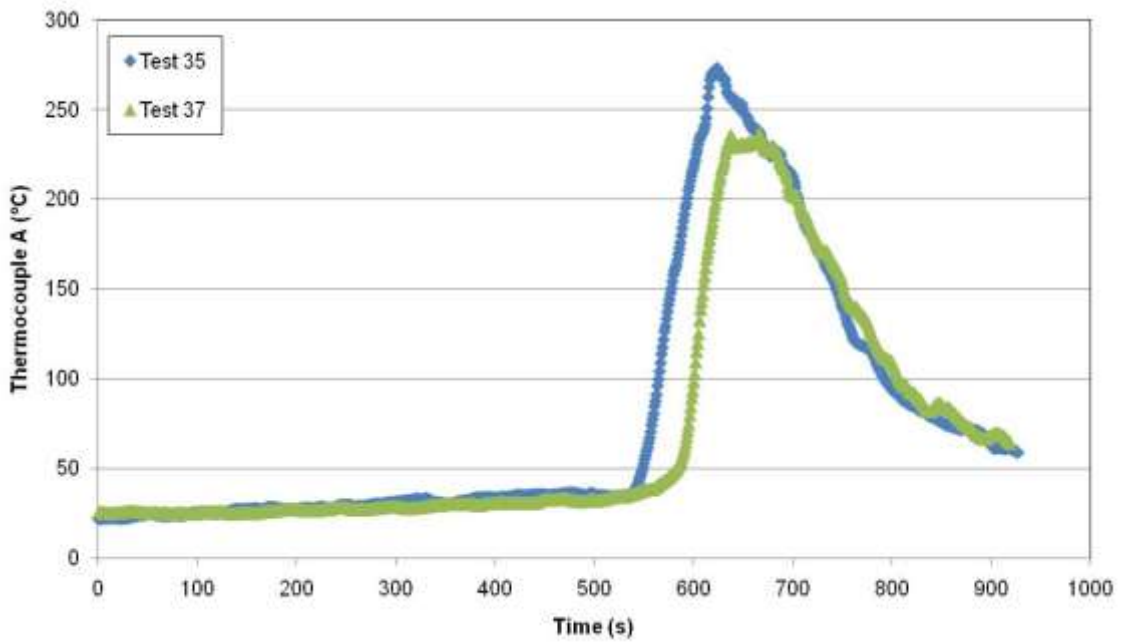

(a)

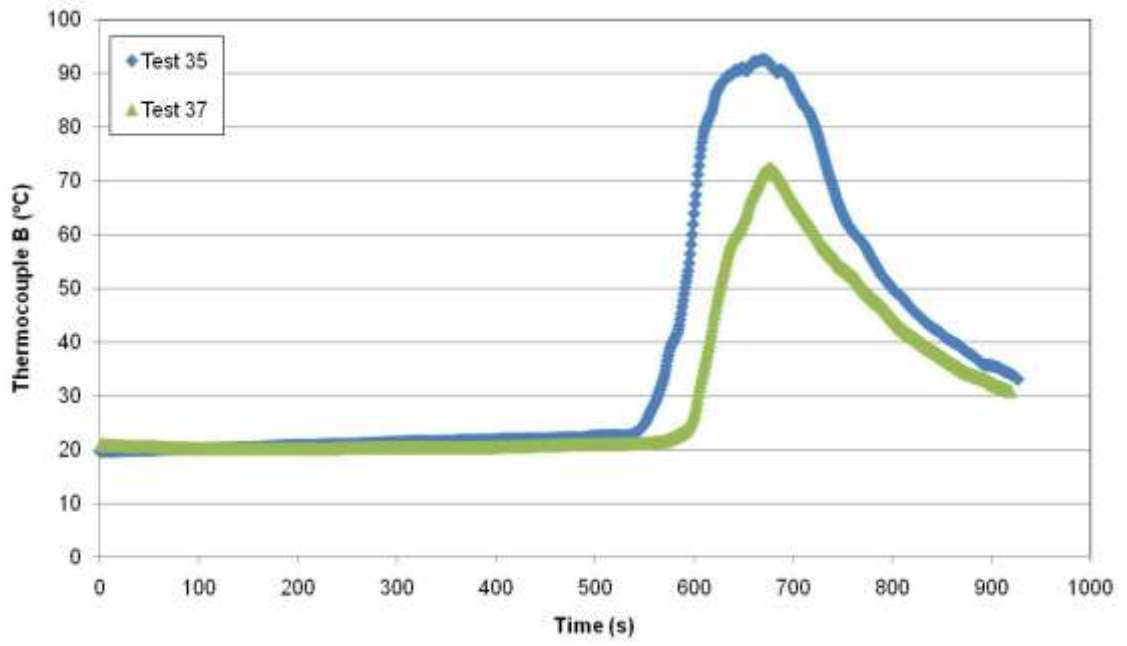

(b)

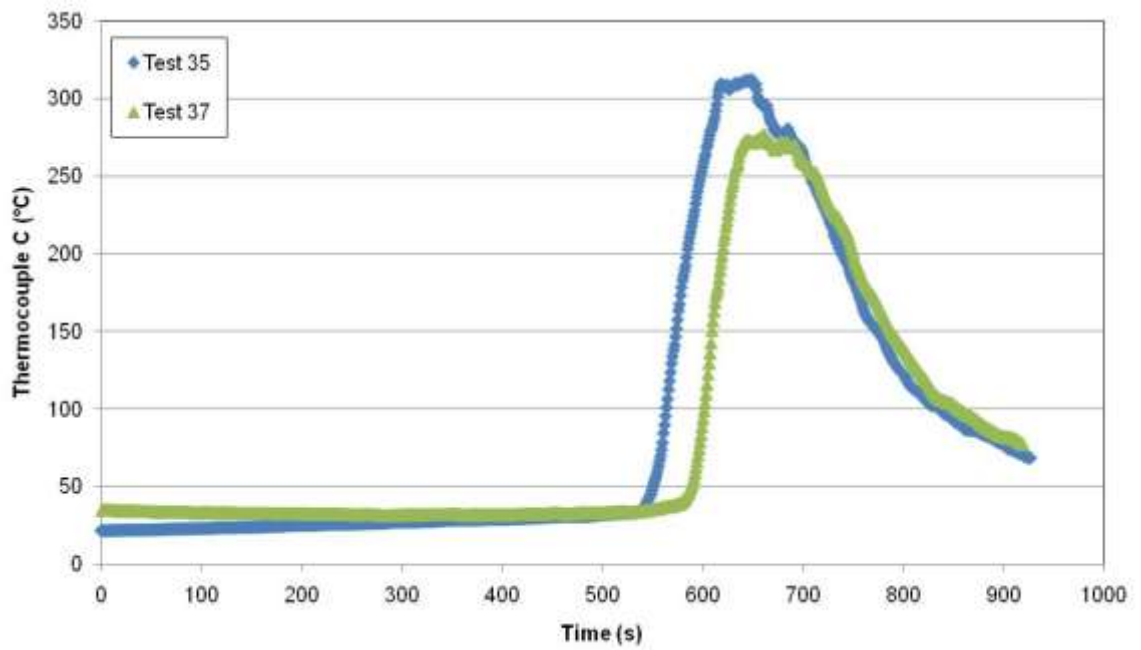

(c)

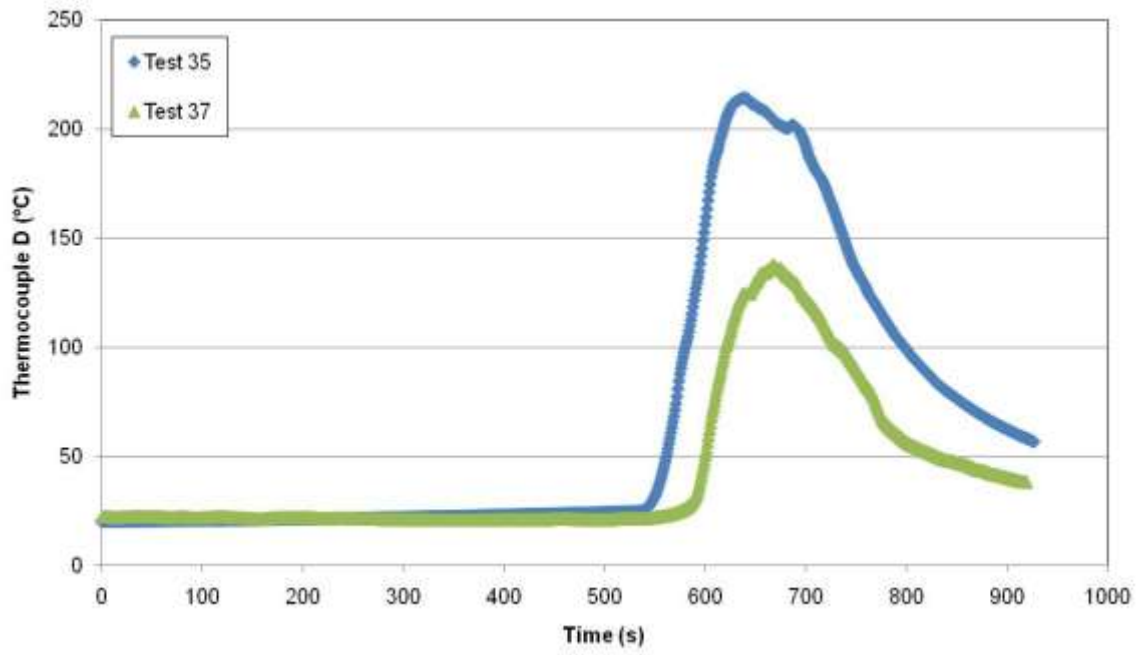

(d)

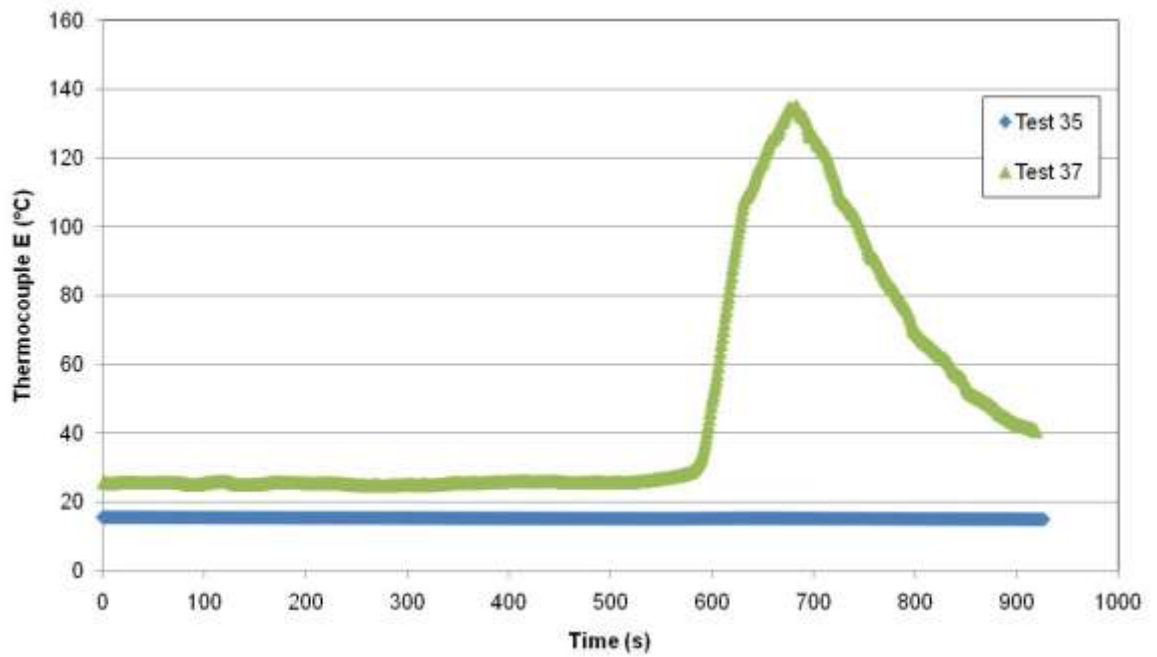

(e)

Figure 78: Thermocouple measurements of (a) thermocouple A, (b) thermocouple B, (c) thermocouple C, (d) thermocouple D, and (e) thermocouple E for Tests 35 and 37.

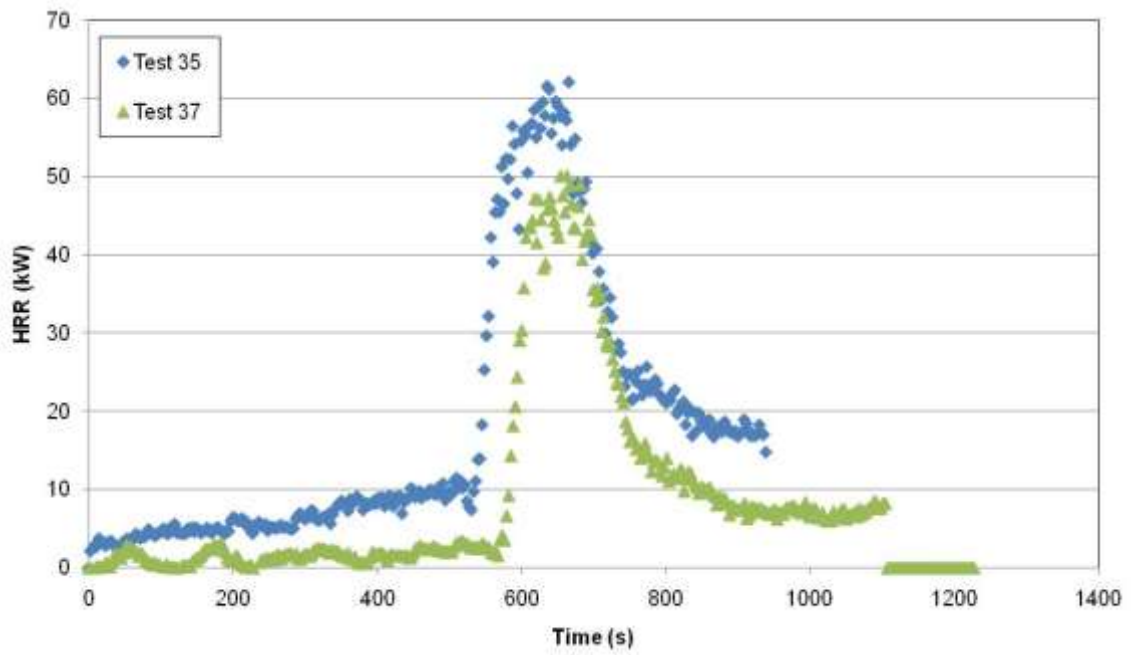
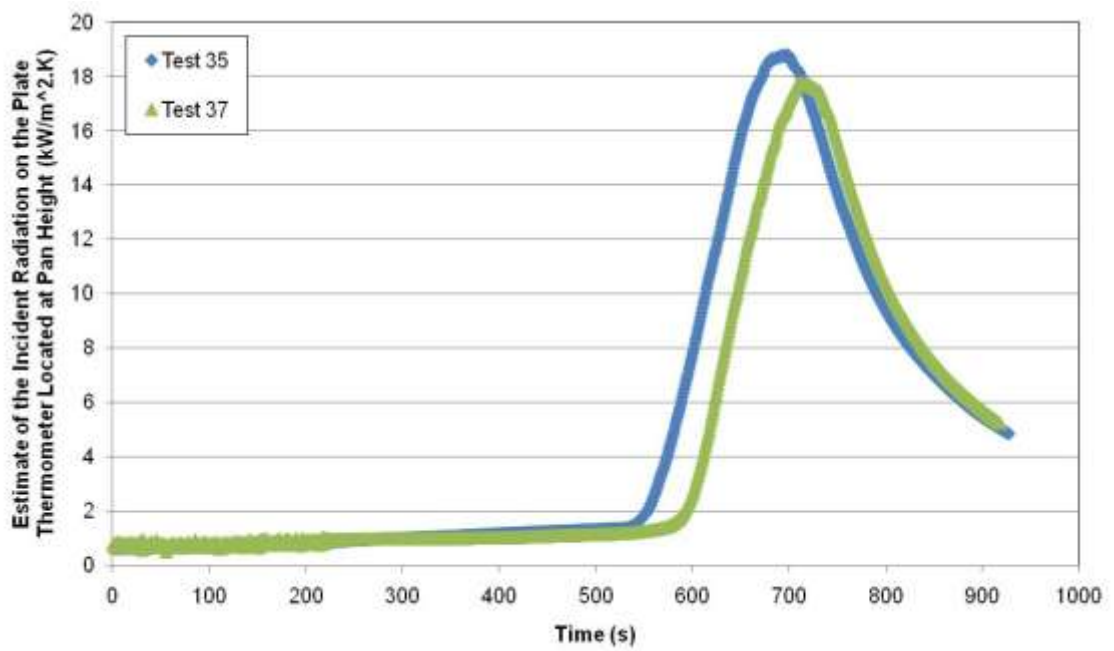
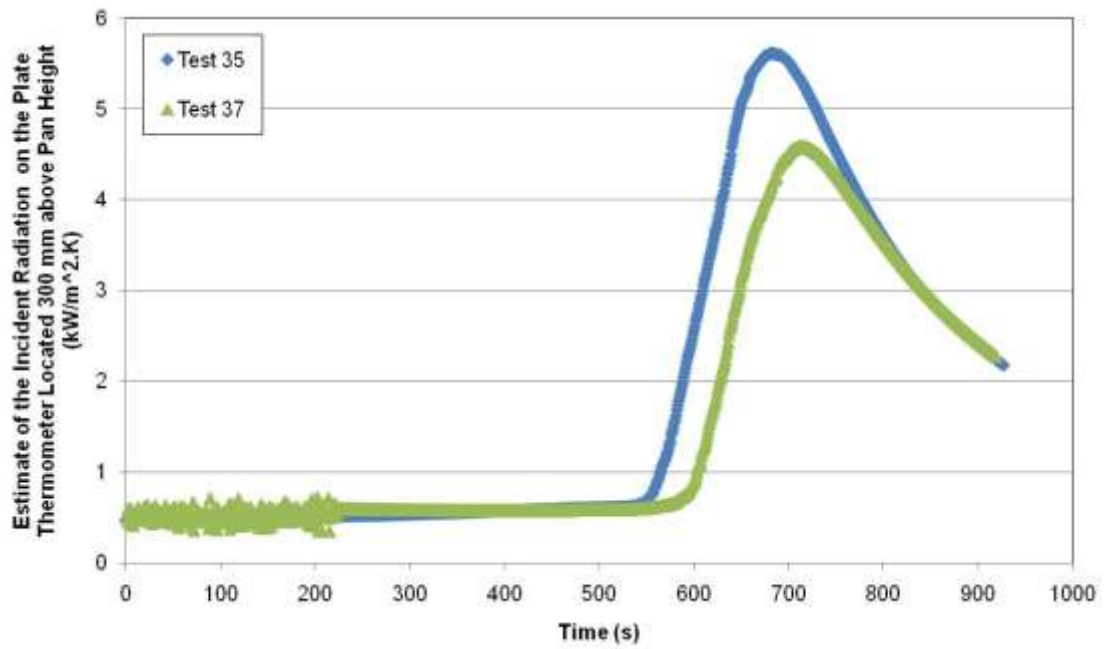

Figure 79: Heat release rates estimated from oxygen calorimetry for Tests 35 and 37.

4.12.1 Analysis



(a)



(b)

Figure 80: Estimates of the incident radiation on the plate thermometer (a) at the height of the lip of the skillet, and (b) 300 mm above the lip of the skillet for Tests 35 and 37.

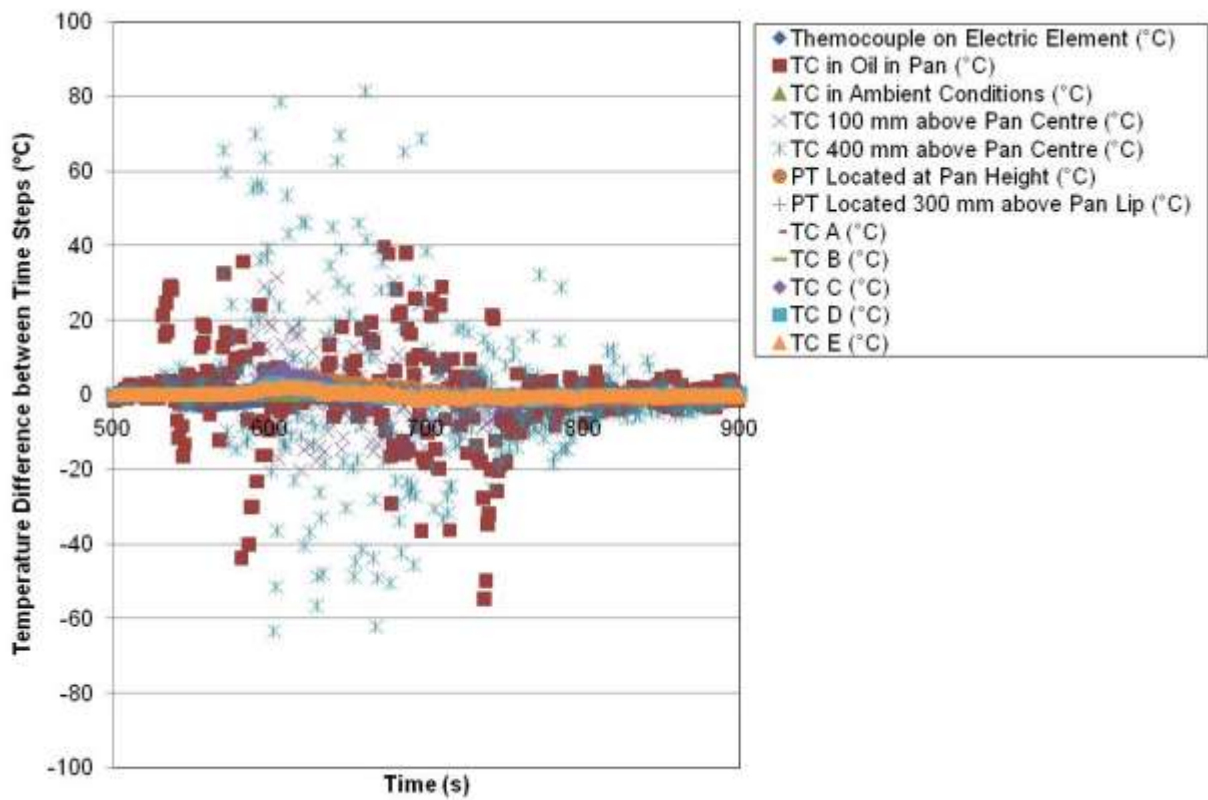

Figure 81: An example of differences of each of the variable temperatures to between sequential time steps for Test 37.

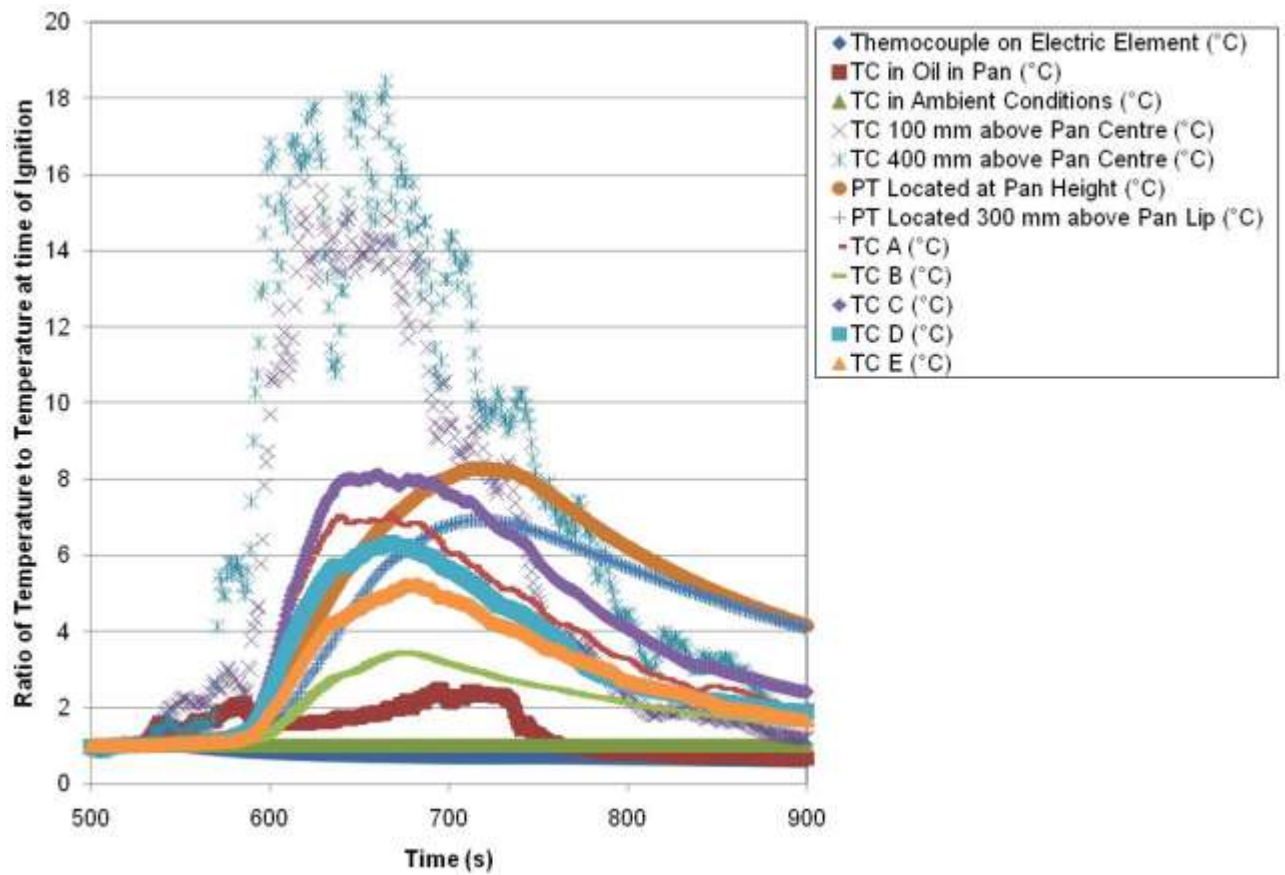
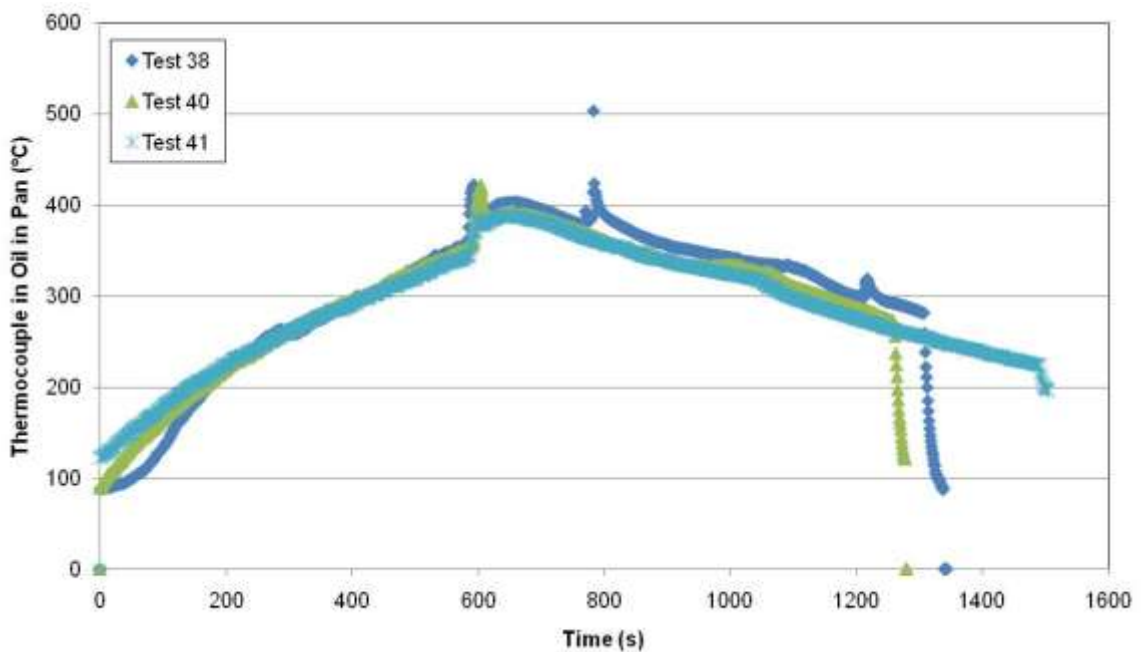

Figure 82: An example of ratios of each of the variable temperatures to the temperatures at the time of ignition for Test 37.

4.13 Skillet with 200 ml Canola Oil, Fan, Fire Blanket & De-energized After Ignition (Tests 38, 40 & 41)

This test was a free-standing electric stove-top under the furniture calorimeter hood with the fan turned on (also allowing data to be collected for the heat release rate) where the flaming pan was manually covered with a fire blanket within 10 s of the first observation of flames and the heating element was subsequently de-energized. The skillet, with 200 ml of canola oil, was present on the powered electric element. This test formed a comparison to the results for the setup with a free-standing stove-top and flaming 200 ml canola oil with the extraction fan running (e.g. Section 4.3) and tests where types of fire suppression were applied (e.g. Sections 4.12 and 4.14 - 4.17). Tests 38, 40 and 41 are examples of this scenario.

The thermocouple measurements in the oil and above the centre of the pan are shown in Figure 83. Plate thermometer temperature measurements are shown in Figure 84. Thermocouple measurements for locations on the surface of the stove-top are shown in Figure 85. Heat release rates based on oxygen calorimetry are shown in Figure 86. Estimates of the incident radiation on the plate thermometers are shown in Figure 87. An example of the temperature differences between sequential time steps for each of the variables recorded is shown in Figure 88 for Test 38 (where the time shown is based on the original test data, as included in Appendices C and D). An example of the ratios of temperatures to the temperature at the time of ignition for each of the variables recorded is shown in Figure 89 for Test 38 (where the time shown is based on the original test data, as included in Appendices C and D).



(a)

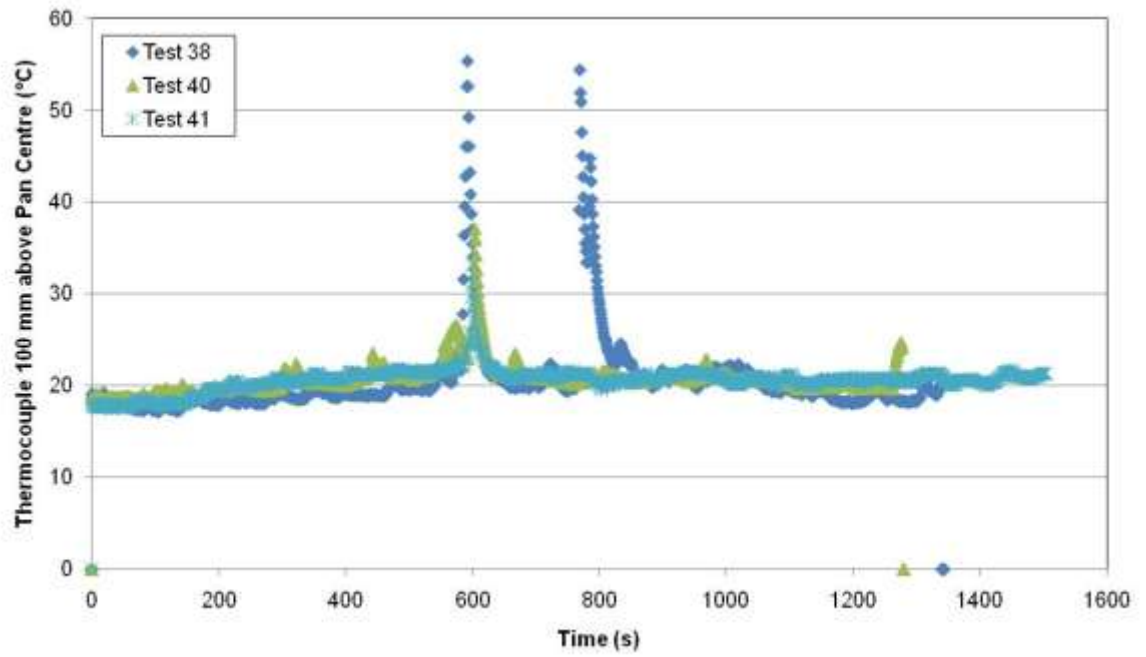

(b)

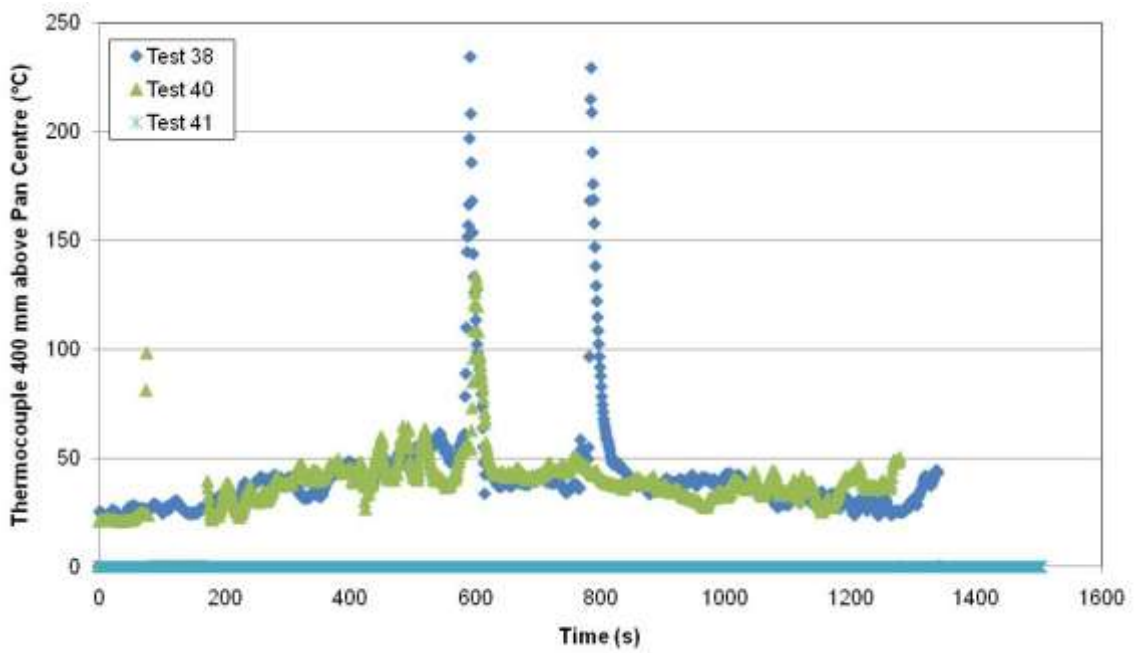

(c)

Figure 83: Thermocouple measurements for the thermocouple located (a) in the oil in the stock pot, (b) 100 mm above the centre of the skillet, and (c) 400 mm above the centre of the stock pot for Tests 38, 40 and 41.

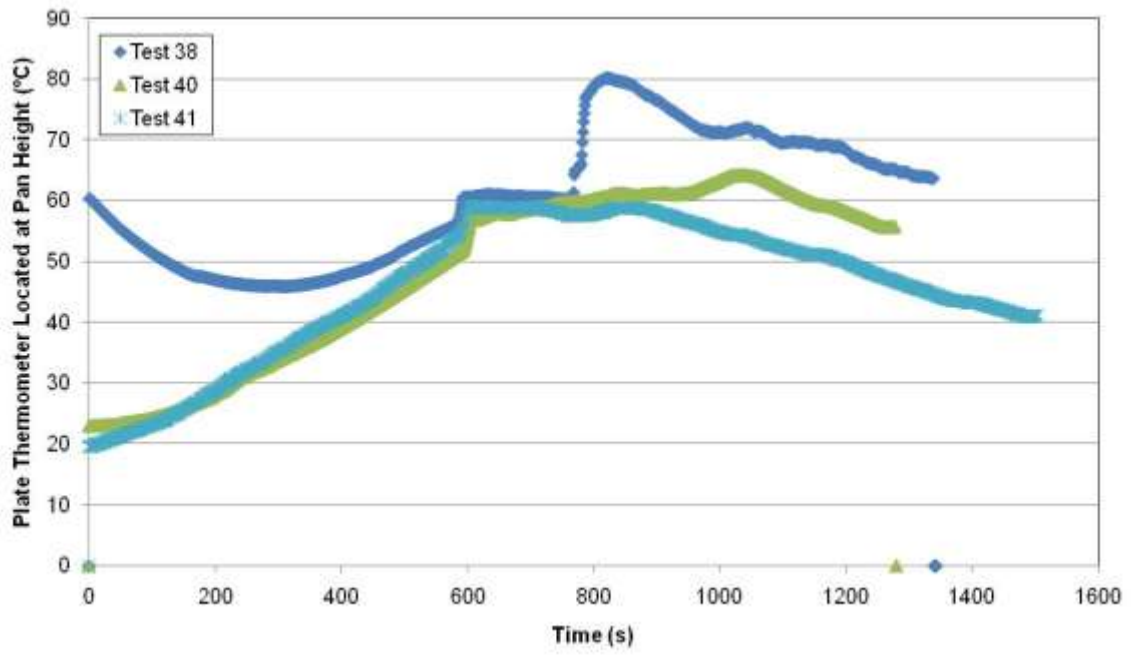

(a)

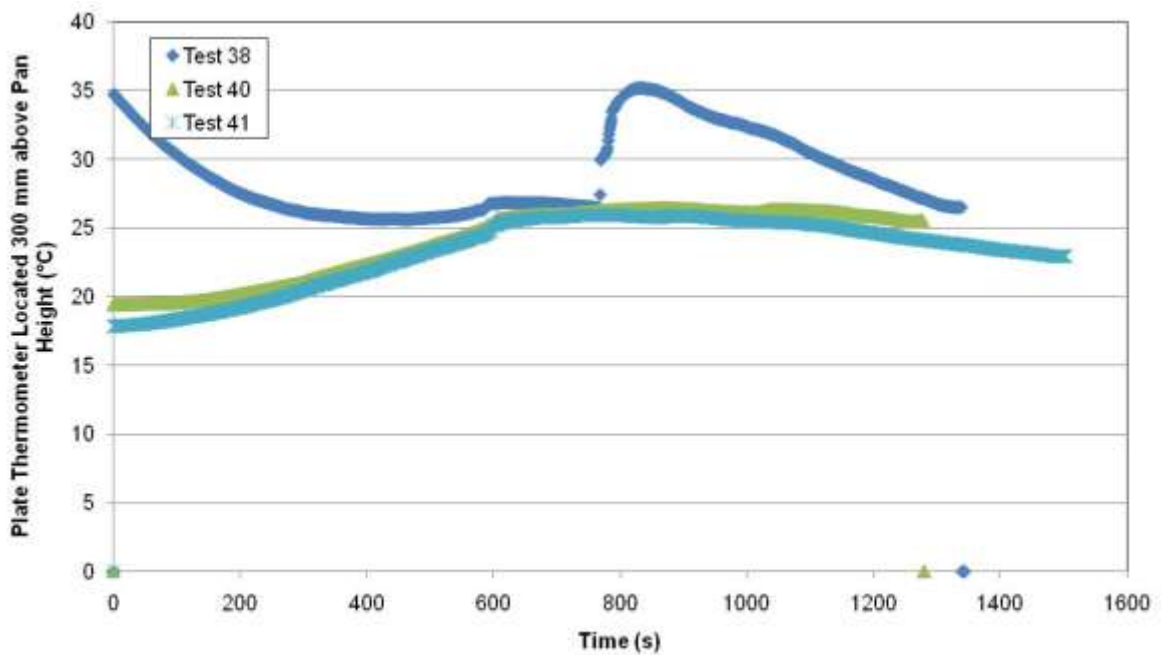

(b)

Figure 84: Plate thermometer temperature measurements for (a) 50 mm above the surface of the stove-top, and (b) 350 mm above the surface of the stove-top for Tests 38, 40 and 41.

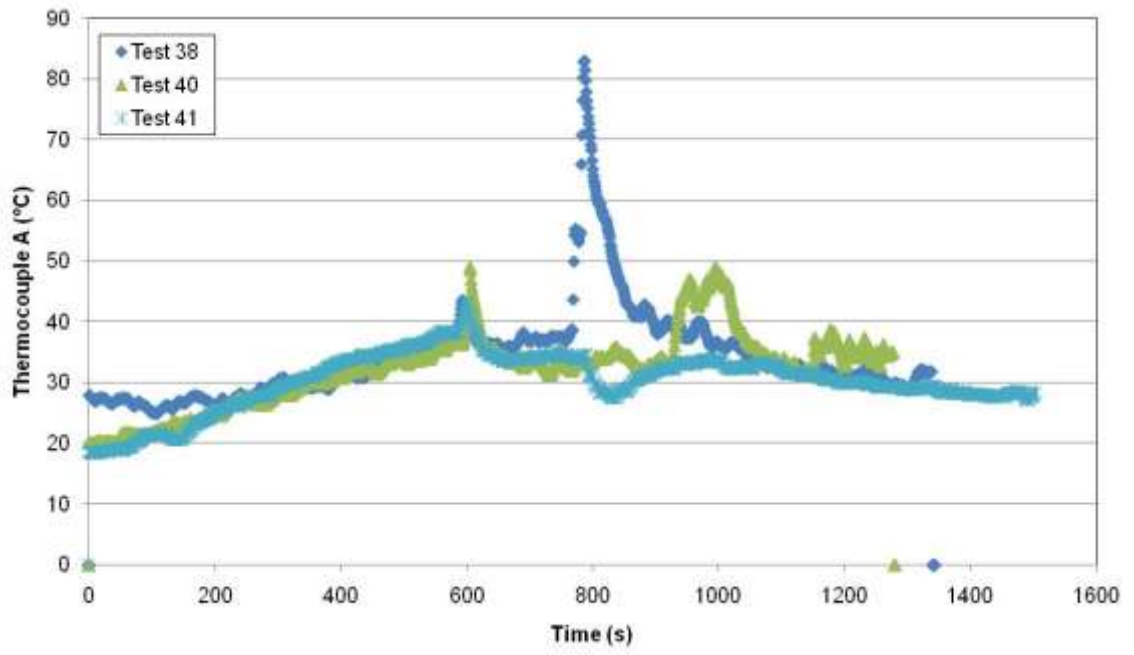

(a)

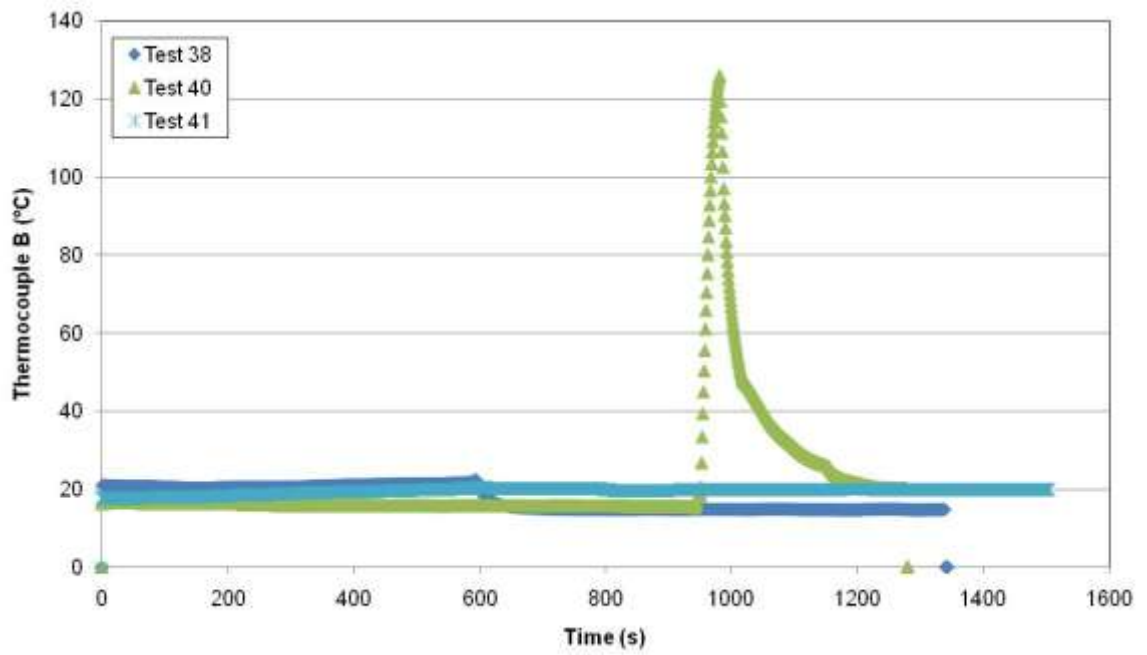

(b)

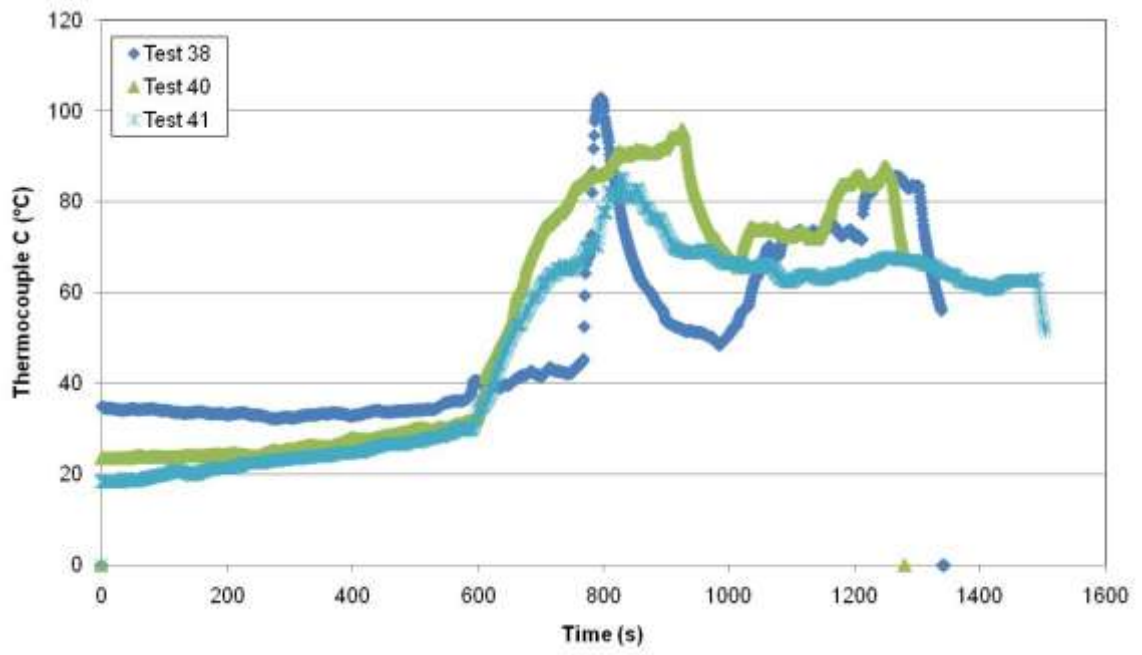

(c)

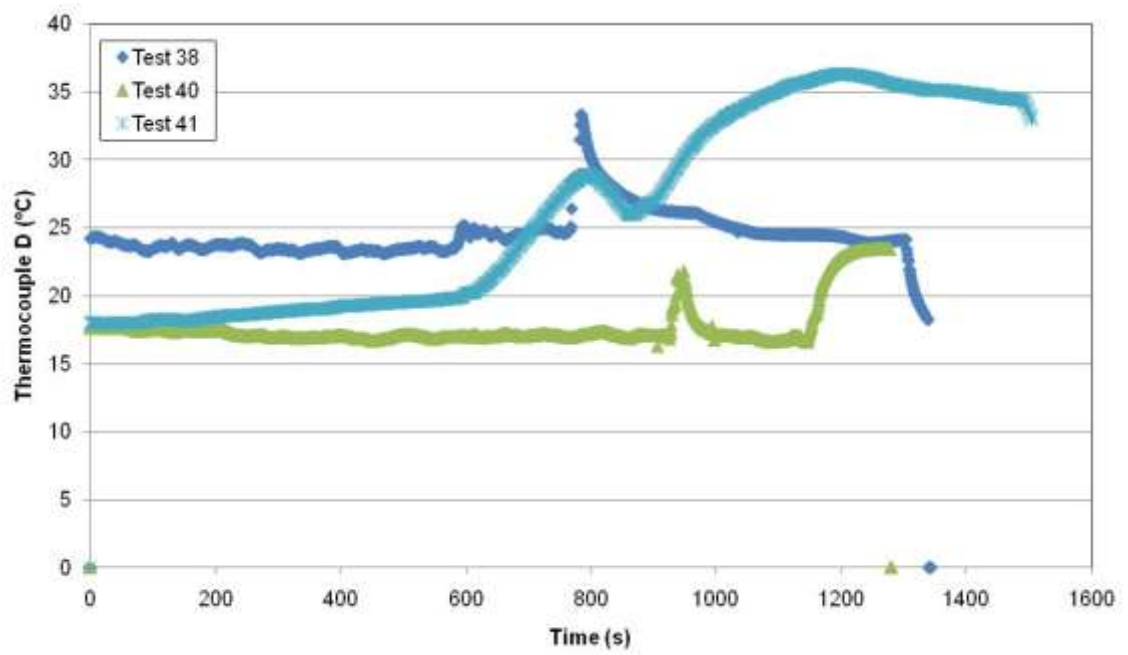

(d)

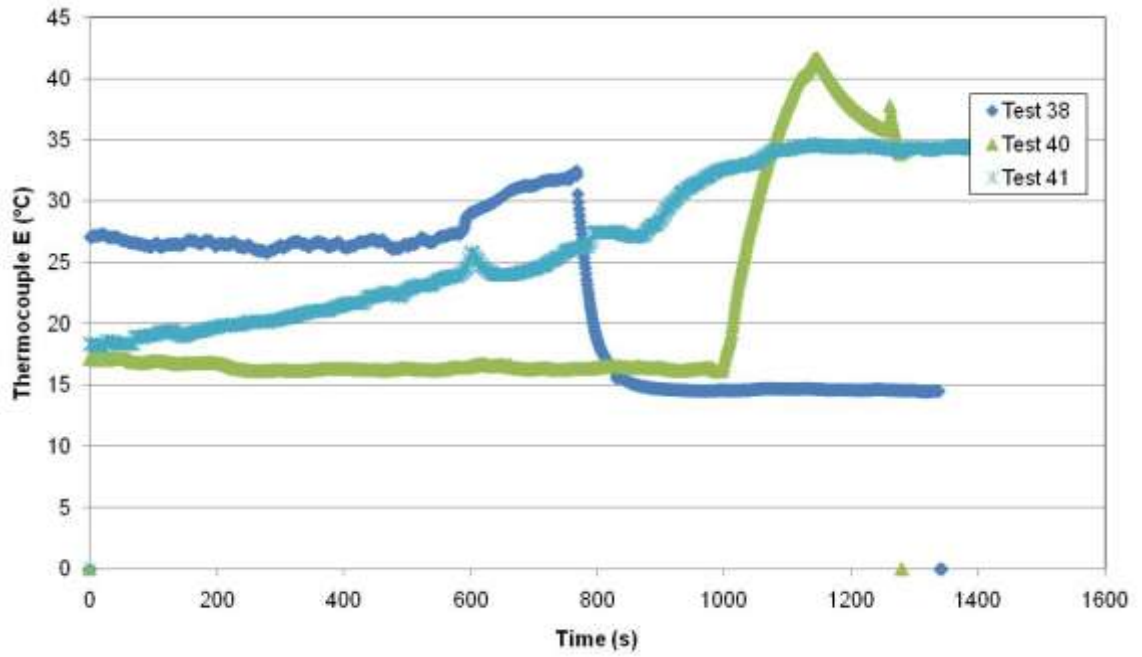

(e)

Figure 85: Thermocouple measurements of (a) thermocouple A, (b) thermocouple B, (c) thermocouple C, (d) thermocouple D, and (e) thermocouple E for Tests 38, 40 and 41.

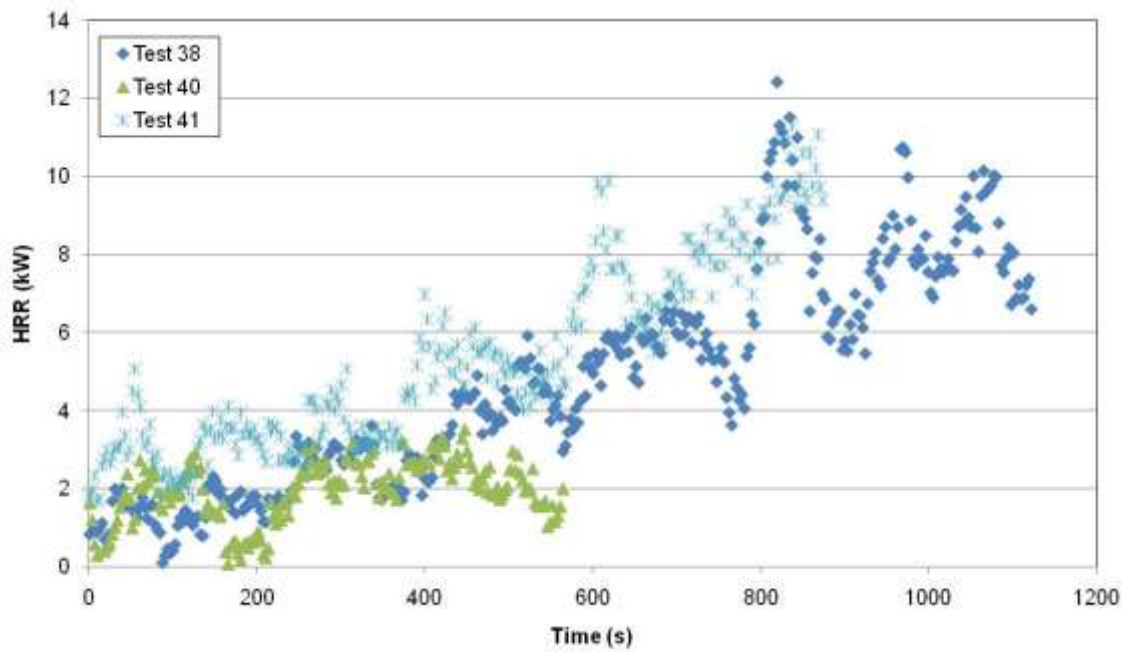
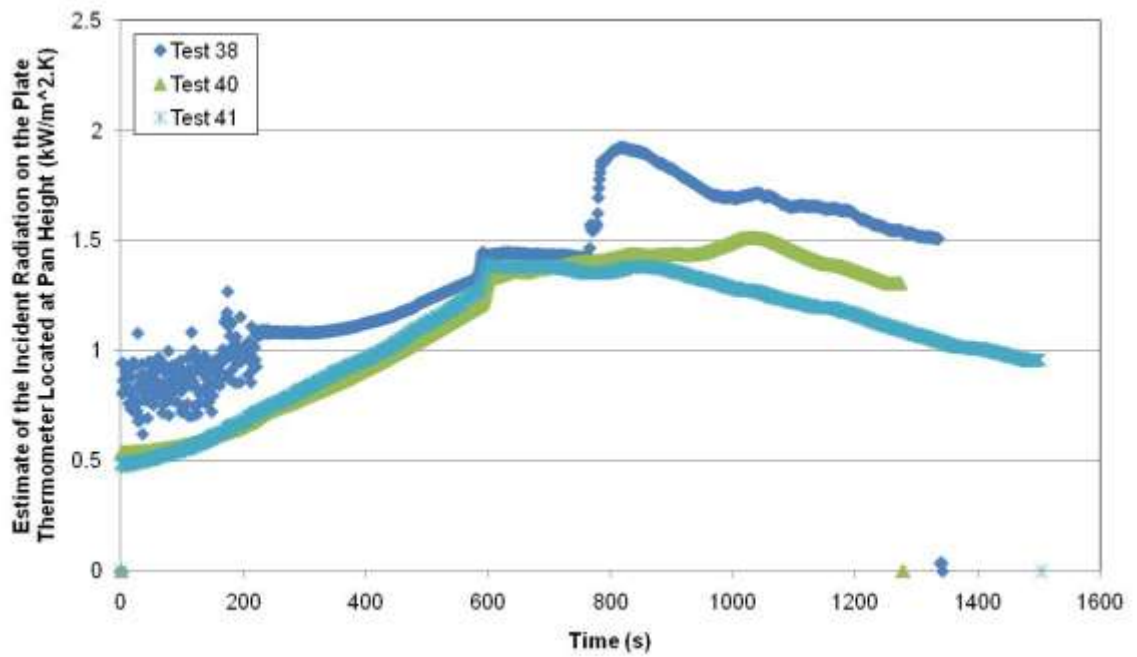
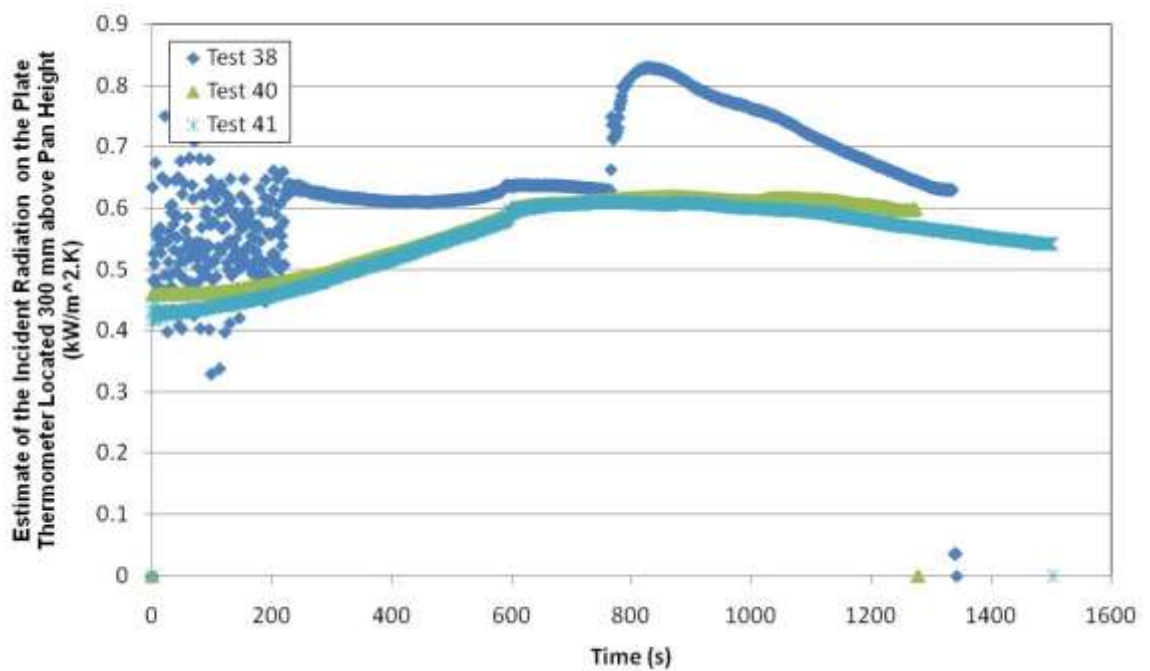

Figure 86: Heat release rates estimated from oxygen calorimetry for Tests 38, 40 and 41.

4.13.1 Analysis



(a)



(b)

Figure 87: Estimates of the incident radiation on the plate thermometer (a) 50 mm and (b) 350 mm above the surface of the stove-top for Tests 38, 40 and 41.

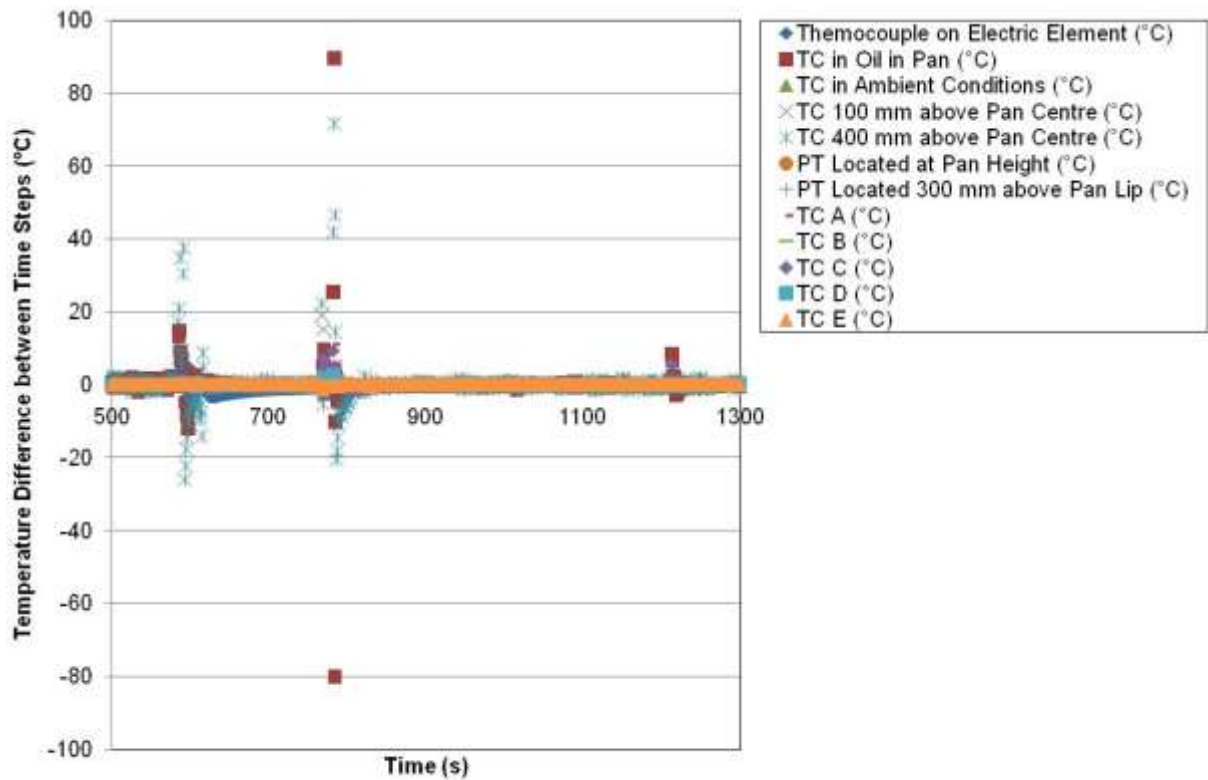

Figure 88: An example of differences of each of the variable temperatures to between sequential time steps for Test 38.

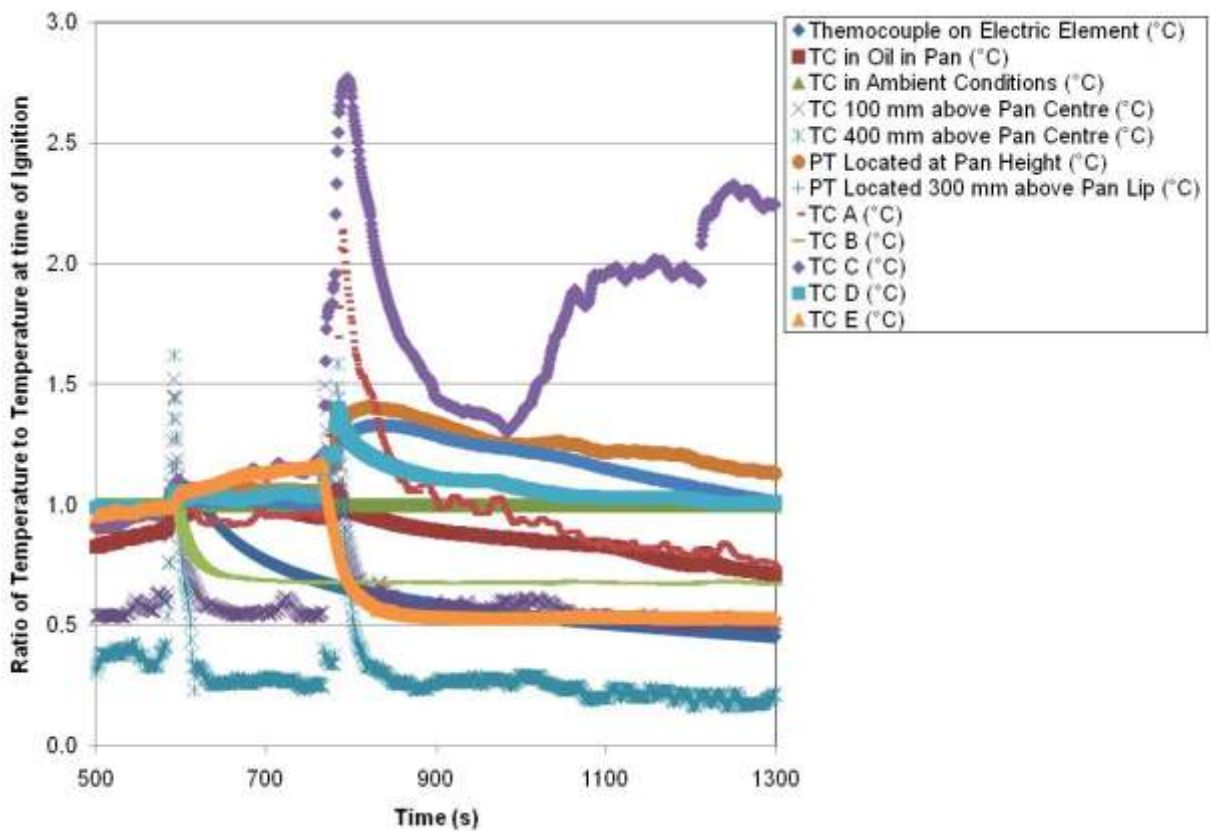
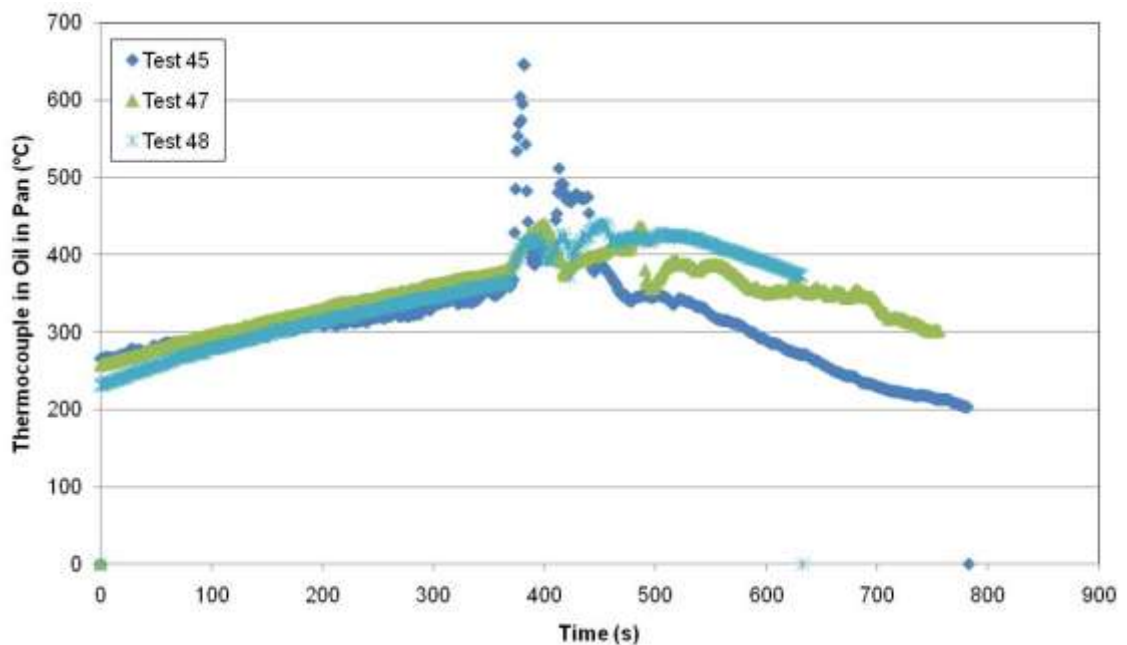

Figure 89: An example of ratios of each of the variable temperatures to the temperatures at the time of ignition for Test 38.

4.14 Skillet with 200 ml Canola Oil, Fan, Dry Powder Extinguisher & De-energized After Ignition (Tests 45, 47 & 48)

This test was a free-standing electric stove-top under the furniture calorimeter hood with the fan turned on (also allowing data to be collected for the heat release rate) where the flaming pan was manually covered using a dry powder extinguisher within 10 s of the first observation of flames and the heating element was subsequently de-energized. The skillet, with 200 ml of canola oil, was present on the powered electric element. This test formed a comparison to the results for the setup with a free-standing stove-top and flaming 200 ml canola oil with the extraction fan running (e.g. Section 4.3) and tests where types of fire suppression were applied (e.g. Sections 4.12, 4.13 and 4.15 - 4.17). Tests 45, 47 and 48 are examples of this scenario.

The thermocouple measurements in the oil and above the centre of the pan are shown in Figure 90. Plate thermometer temperature measurements are shown in Figure 91. Thermocouple measurements for locations on the surface of the stove-top are shown in Figure 92. Heat release rates based on oxygen calorimetry are shown in Figure 93. Estimates of the incident radiation on the plate thermometers are shown in Figure 94. An example of the temperature differences between sequential time steps for each of the variables recorded is shown in Figure 95 for Test 47 (where the time shown is based on the original test data, as included in Appendices C and D). An example of the ratios of temperatures to the temperature at the time of ignition for each of the variables recorded is shown in Figure 96 for Test 47 (where the time shown is based on the original test data, as included in Appendices C and D).



(a)

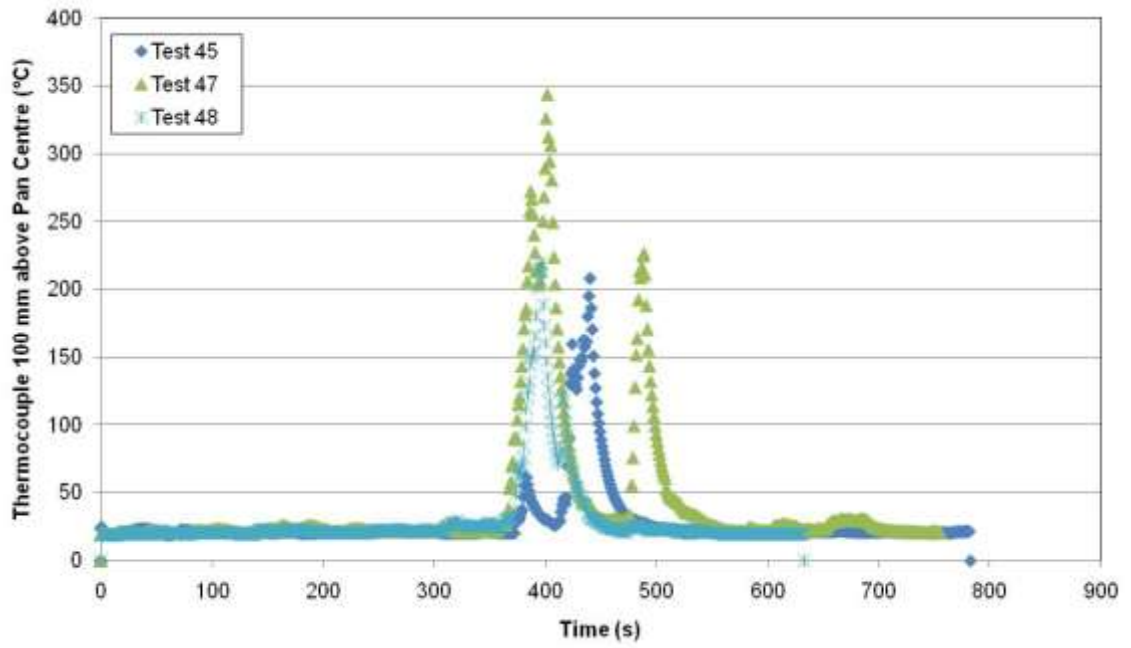

(b)

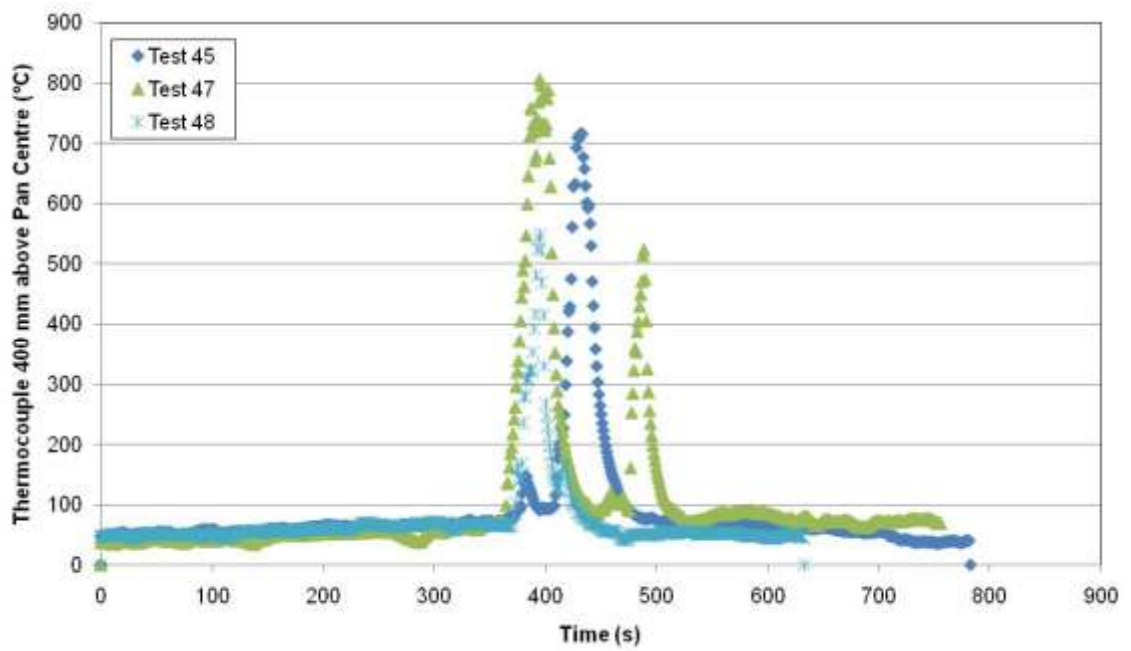

(c)

Figure 90: Thermocouple measurements for the thermocouple located (a) in the oil in the stock pot, (b) 100 mm above the centre of the skillet, and (c) 400 mm above the centre of the stock pot for Tests 45, 47 and 48.

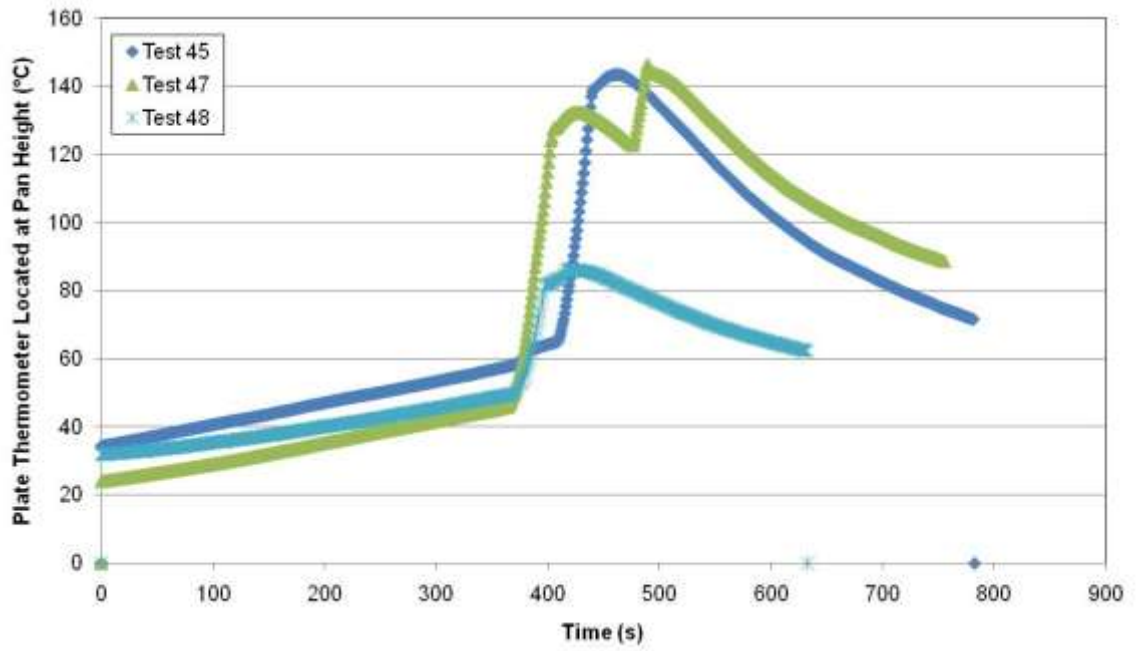

(a)

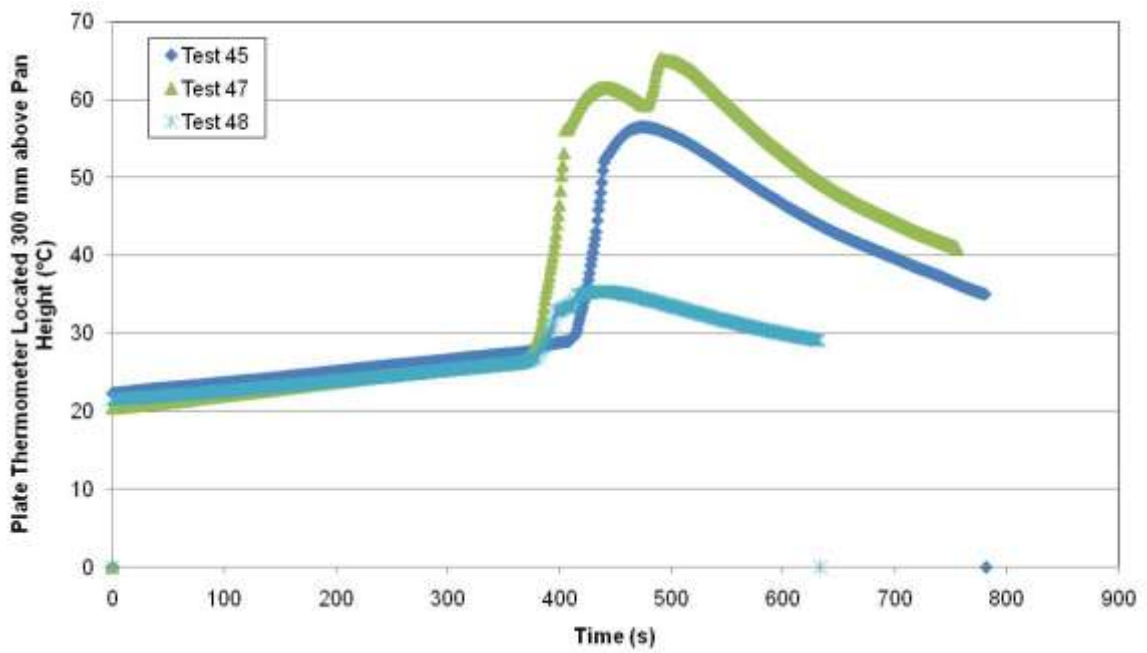

(b)

Figure 91: Plate thermometer temperature measurements for (a) 50 mm above the surface of the stove-top, and (b) 350 mm above the surface of the stove-top for Tests 45, 47 and 48.

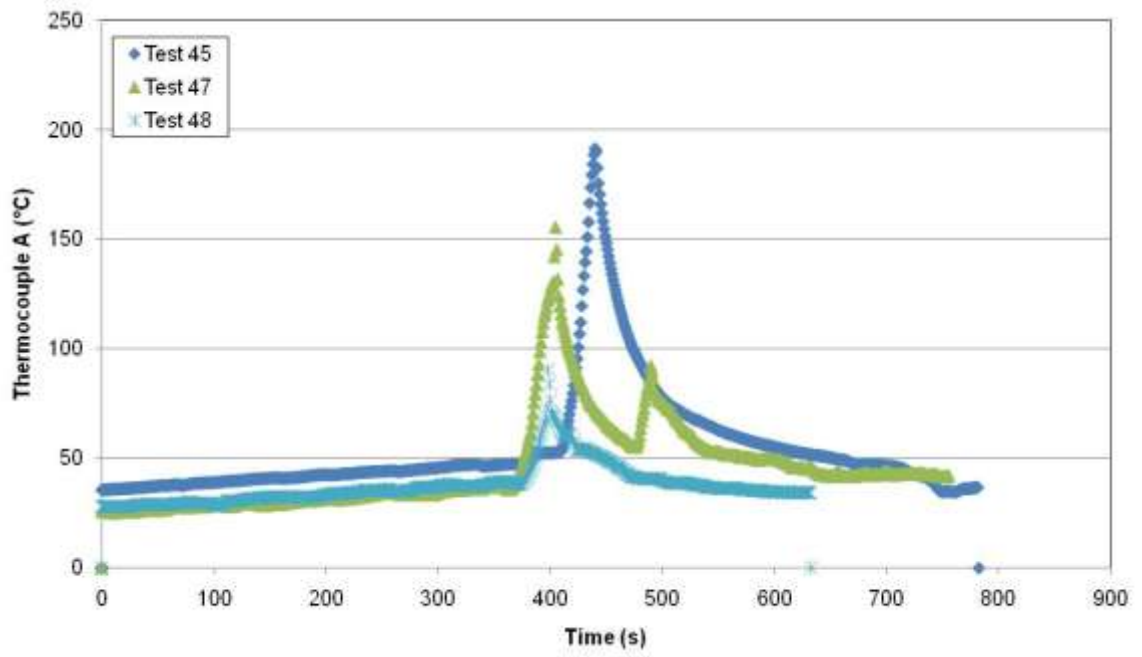

(a)

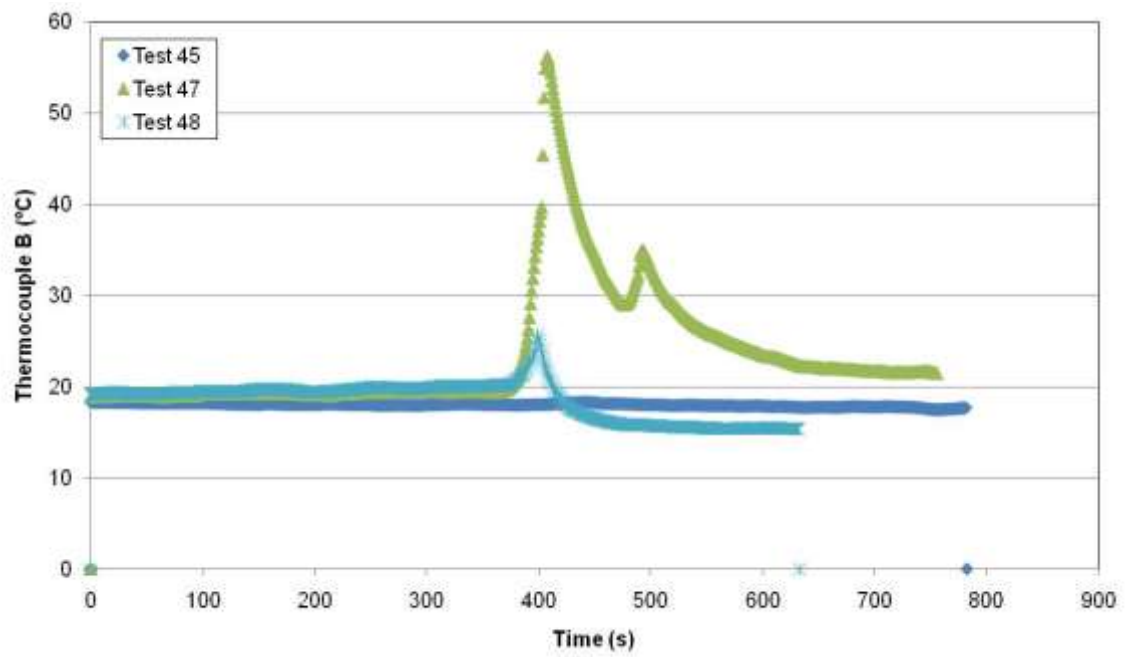

(b)

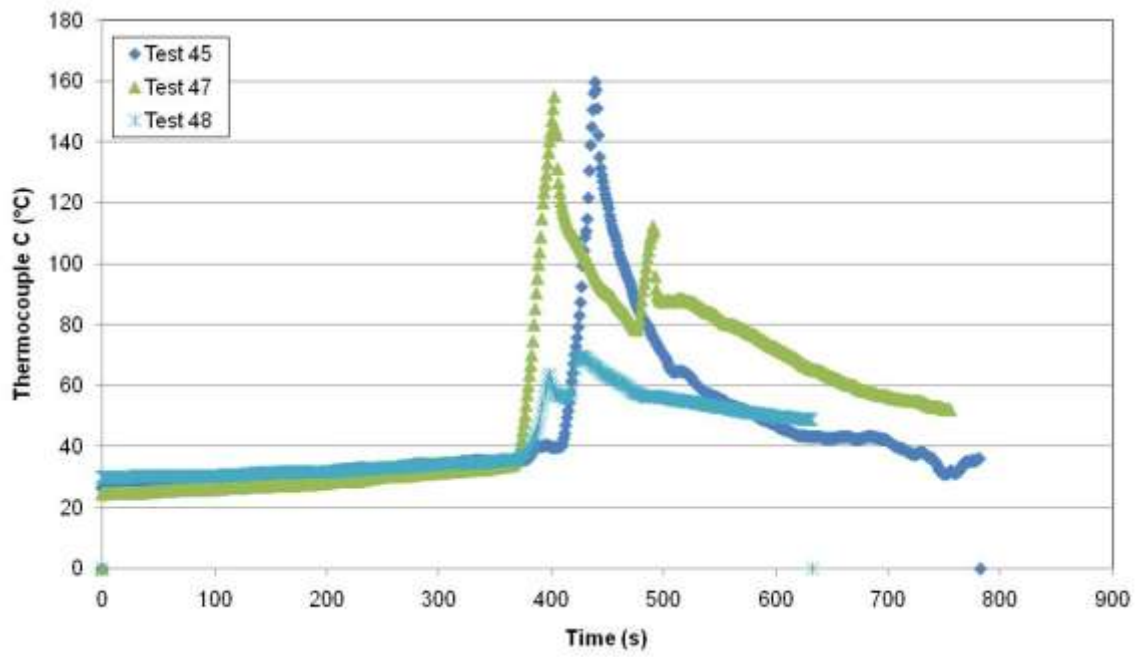

(c)

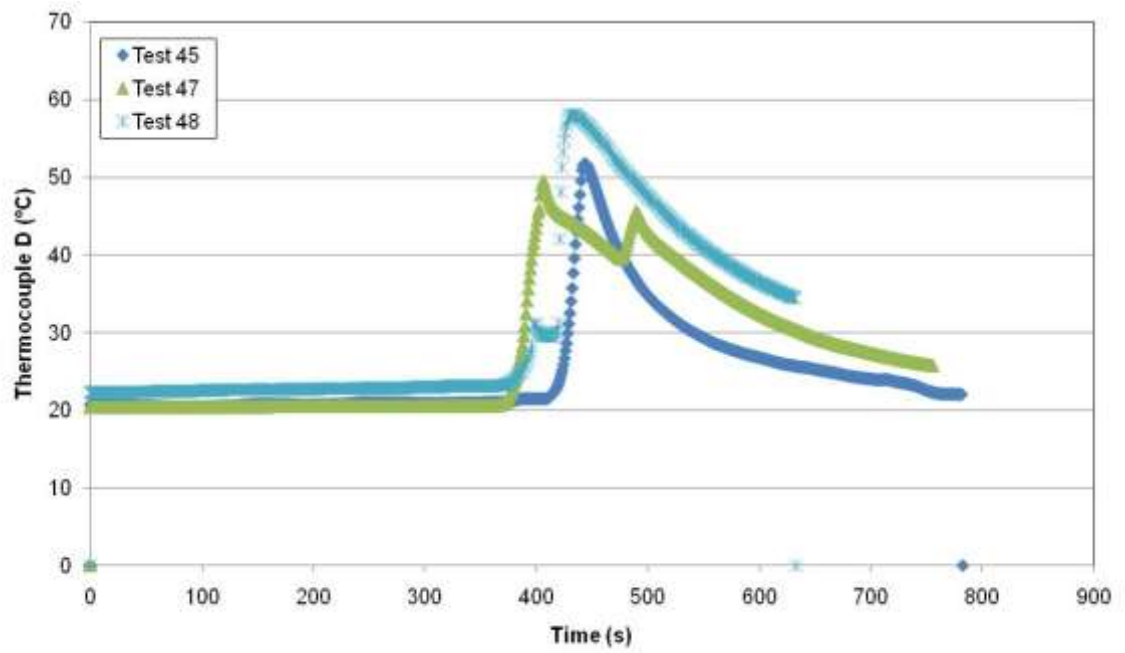

(d)

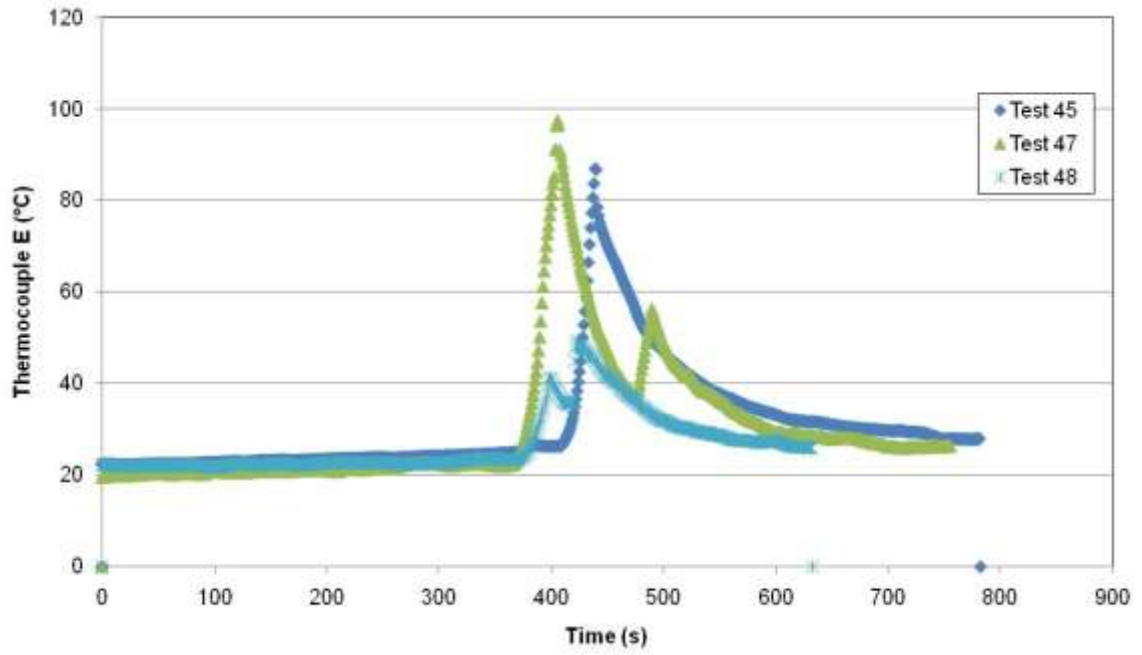

(e)

Figure 92: Thermocouple measurements of (a) thermocouple A, (b) thermocouple B, (c) thermocouple C, (d) thermocouple D, and (e) thermocouple E for Tests 45, 47 and 48.

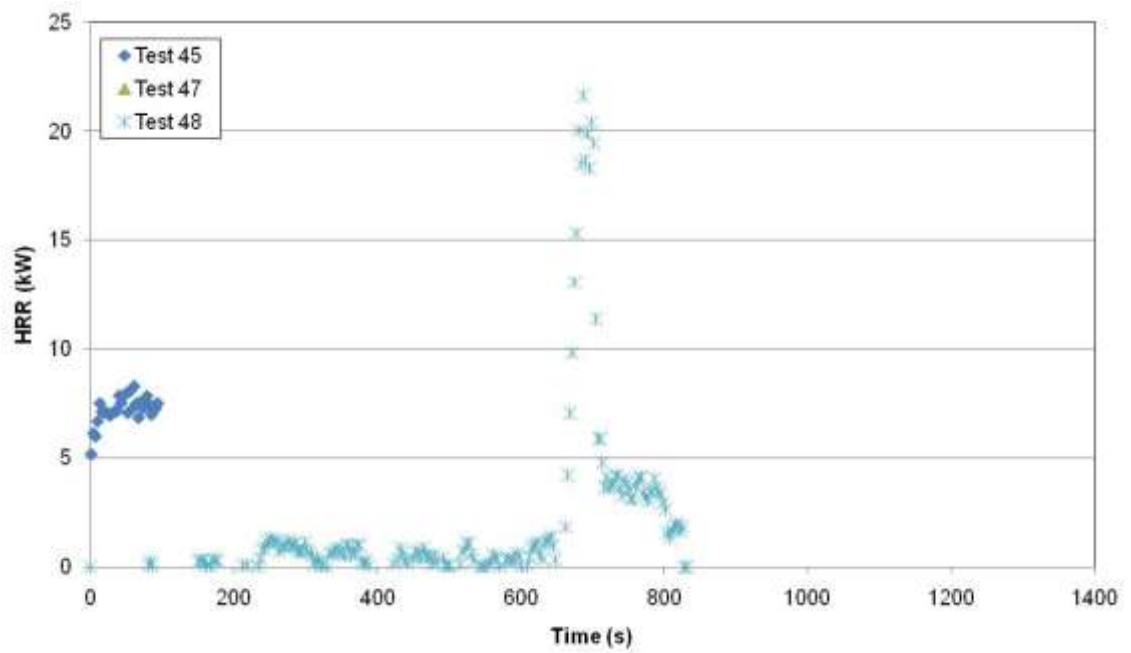
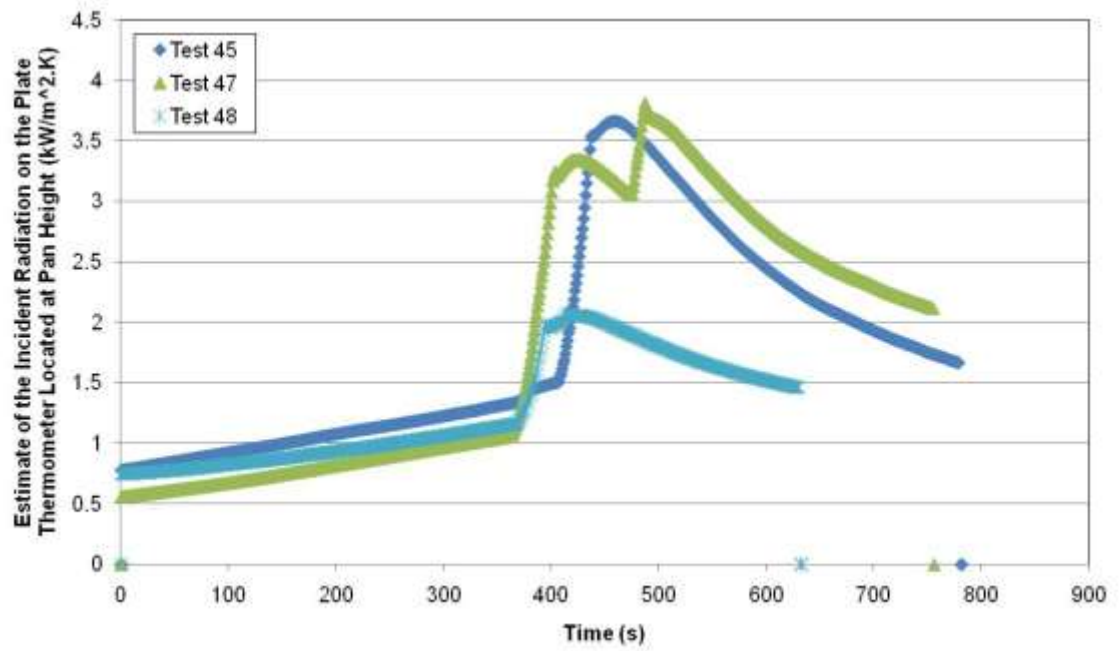
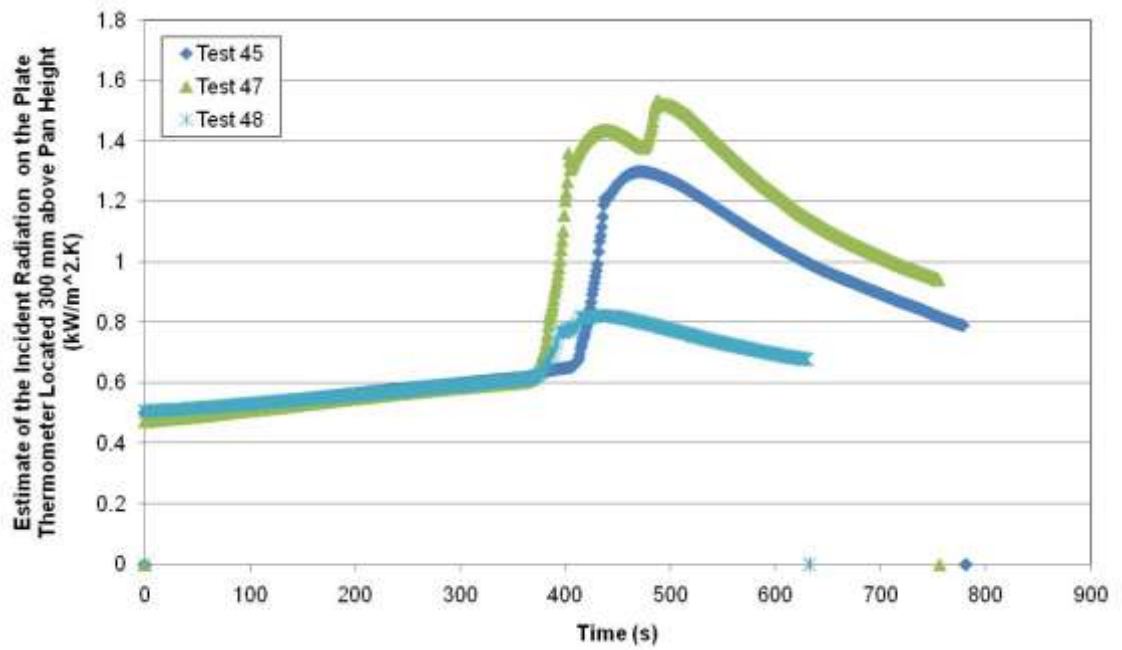

Figure 93: Heat release rates estimated from oxygen calorimetry for Test 48.

4.14.1 Analysis



(a)



(b)

Figure 94: Estimates of the incident radiation on the plate thermometer (a) 50 mm and (b) 350 mm above the surface of the stove-top for Tests 45, 47 and 48.

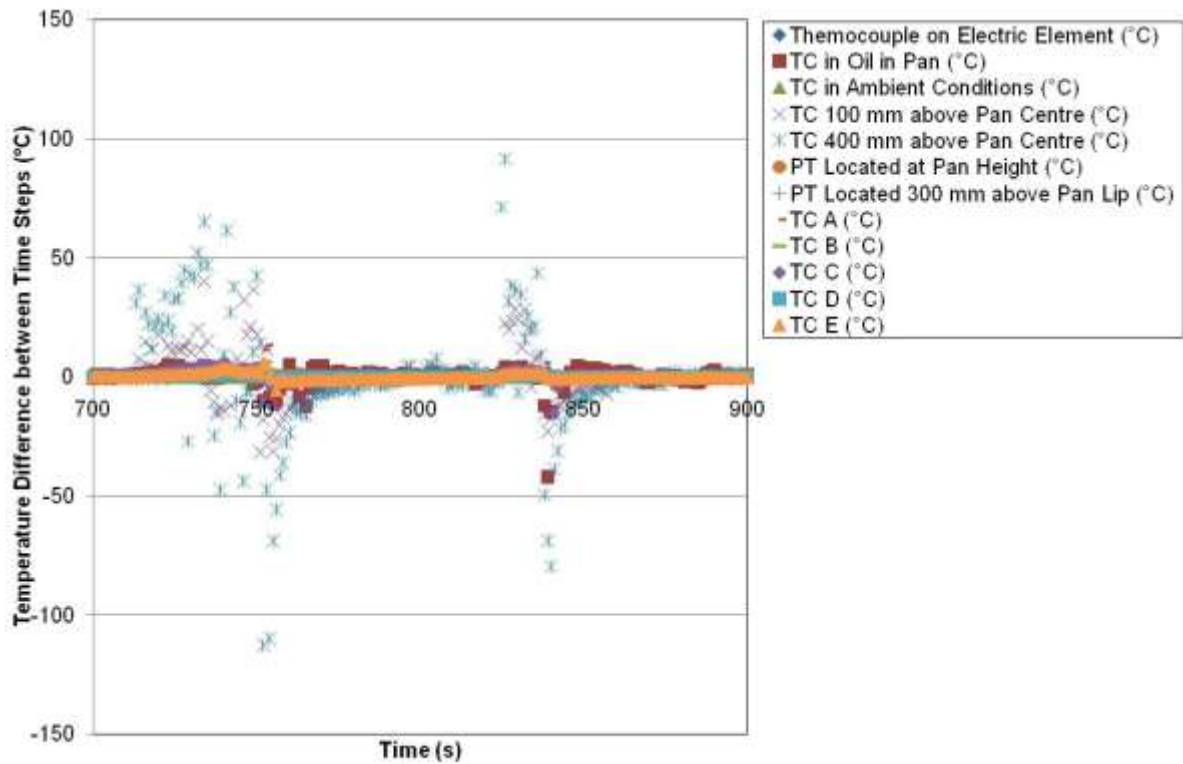

Figure 95: An example of differences of each of the variable temperatures to between sequential time steps for Test 47.

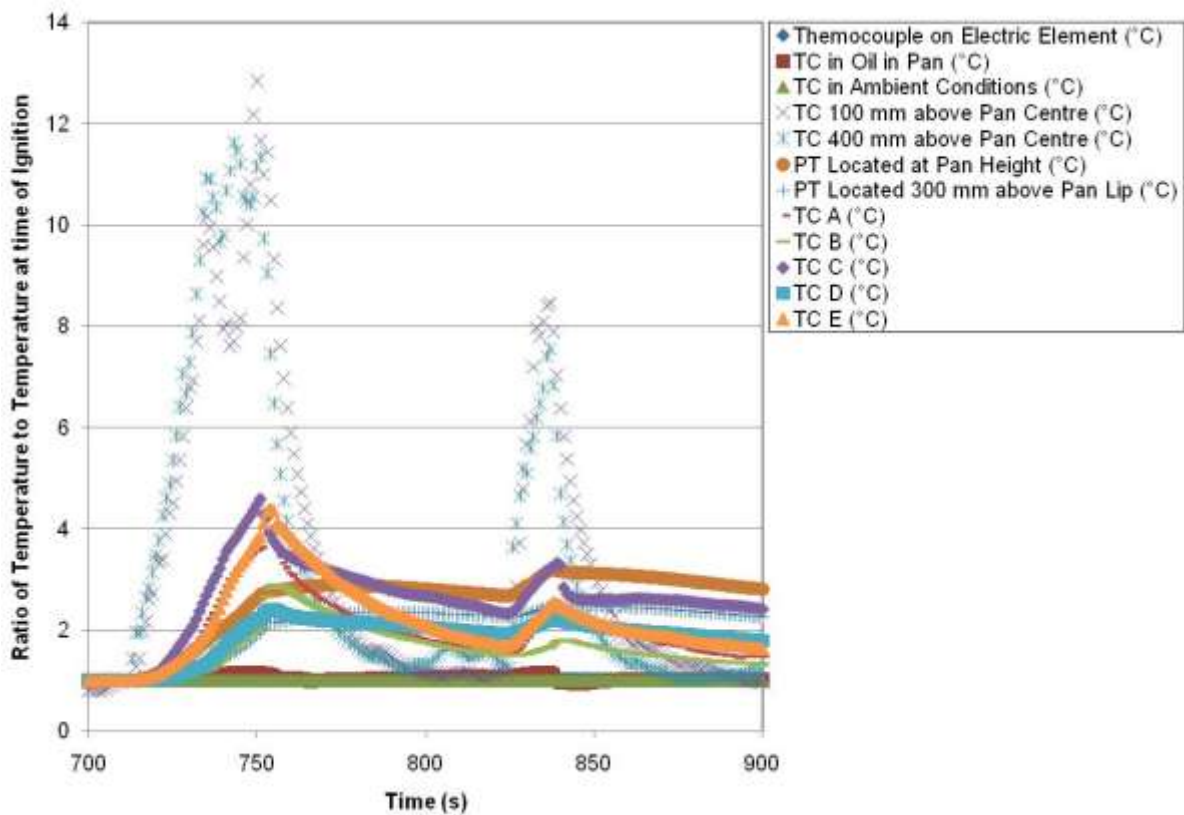
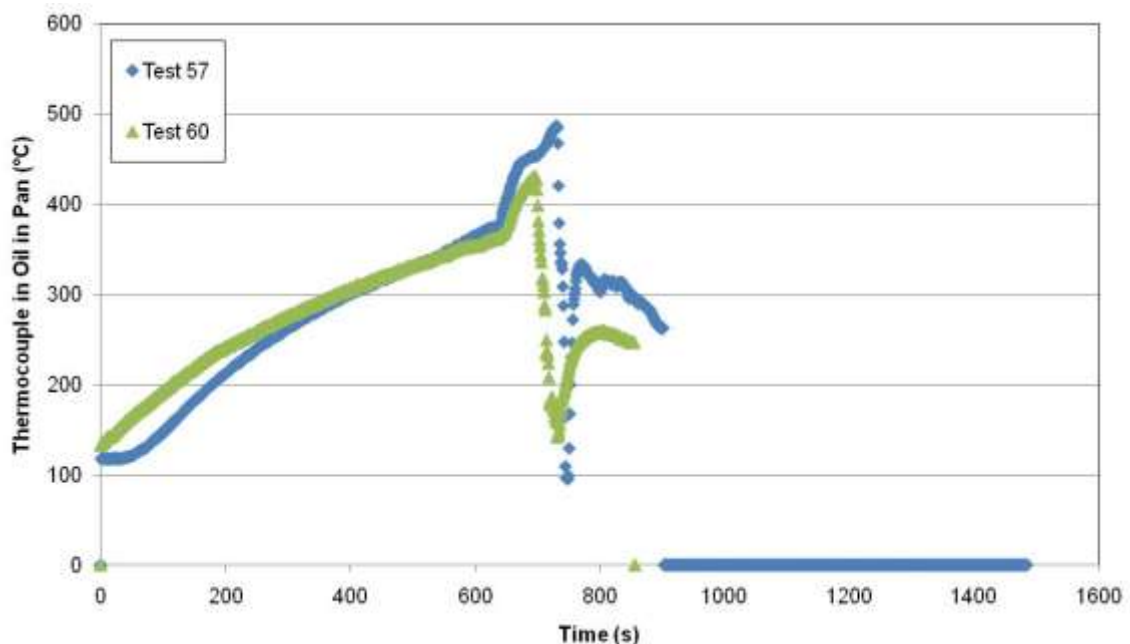

Figure 96: An example of ratios of each of the variable temperatures to the temperatures at the time of ignition for Test 47.

4.15 Skillet with 200 ml Canola Oil, Fan, Single Automatic Sprinkler Head (Tests 57, 60)

This test was a electric stove-top against a wall in the partial corridor under the furniture calorimeter hood with the fan turned on (also allowing data to be collected for the heat release rate). A single residential sprinkler head was located 1500 mm from the wall and centrally in the width of the partial corridor. The water supply to the sprinkler head was turned on before the start of the test and manually turned off after flameout was observed for each test. The skillet, with 200 ml of canola oil, was present on the powered electric element. This test formed a comparison to the results for the setup with a stove-top against a wall in the partial corridor and flaming 200 ml canola oil with the extraction fan running with no fire protection systems present (e.g. Section 4.6) and tests where types of fire suppression were applied (e.g. Sections 4.12 - 4.17). Tests 56 and 60 are examples of this scenario.

The thermocouple measurements in the oil and above the centre of the pan are shown in Figure 97. Plate thermometer temperature measurements are shown in Figure 98. Thermocouple measurements for locations on the surface of the stove-top are shown in Figure 99. Thermocouple measurements for locations on the ceiling of the partial corridor are shown in Figure 100. Heat release rates based on oxygen calorimetry are shown in Figure 101. Estimates of the incident radiation on the plate thermometers are shown in Figure 102. An example of the temperature differences between sequential time steps for each of the variables recorded is shown in Figure 103 for Test 57 (where the time shown is based on the original test data, as included in Appendices C and D). An example of the ratios of temperatures to the temperature at the time of ignition for each of the variables recorded is shown in Figure 104 for Test 57 (where the time shown is based on the original test data, as included in Appendices C and D).



(a)

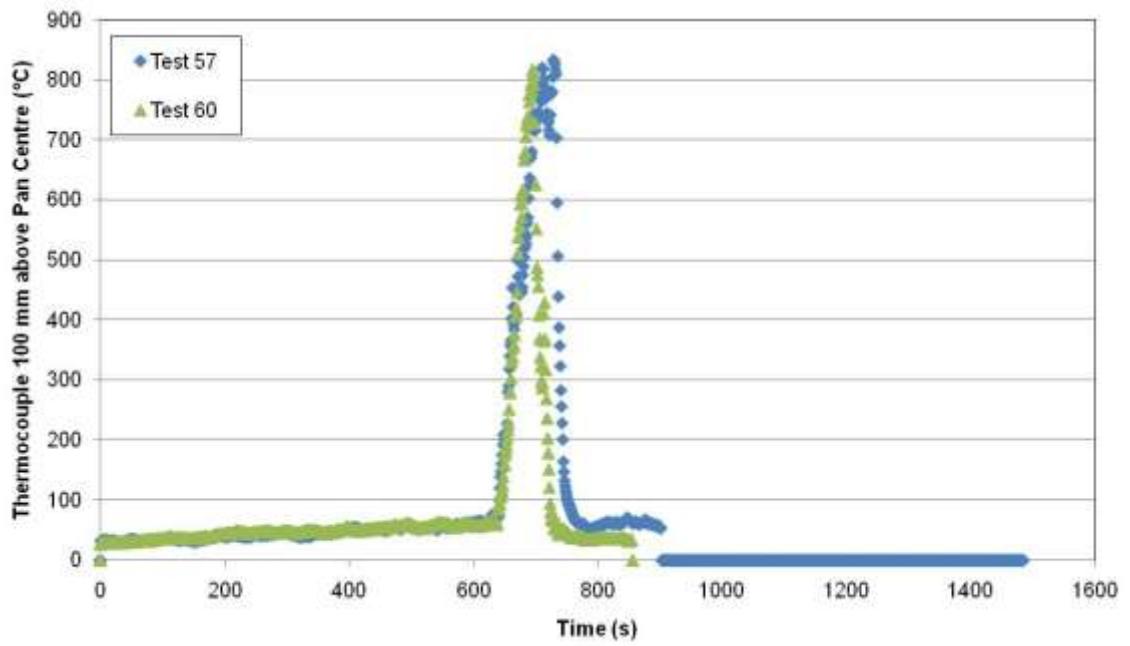

(b)

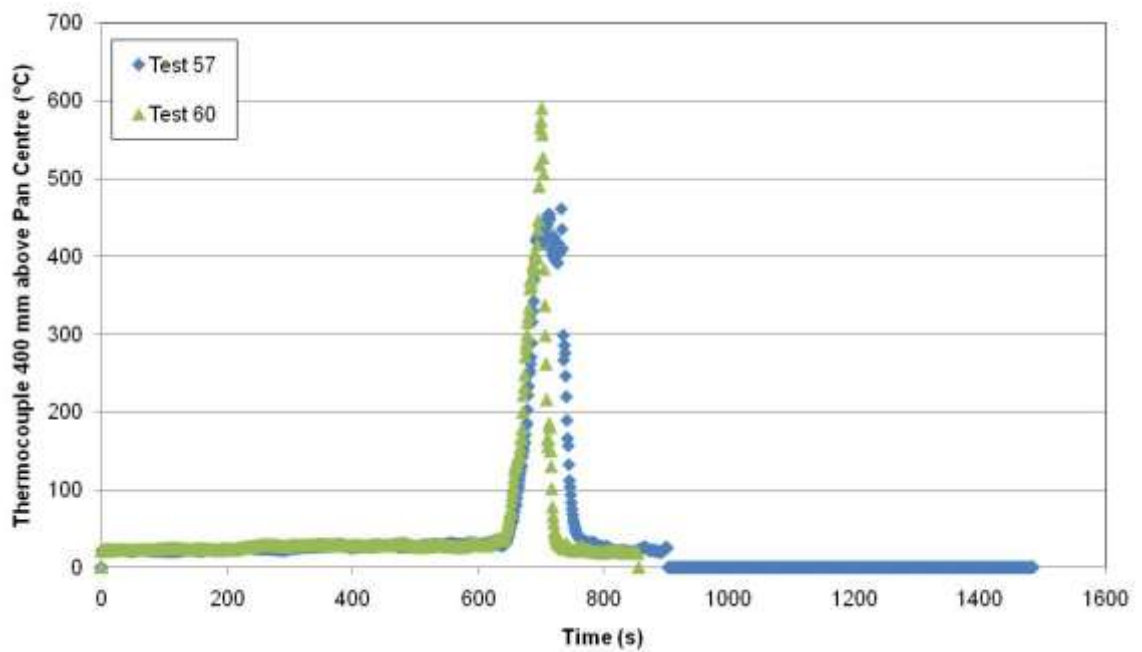

(c)

Figure 97: Thermocouple measurements for the thermocouple located (a) in the oil in the skillet, (b) 100 mm above the centre of the skillet, and (c) 400 mm above the centre of the skillet for Tests 56 and 60.

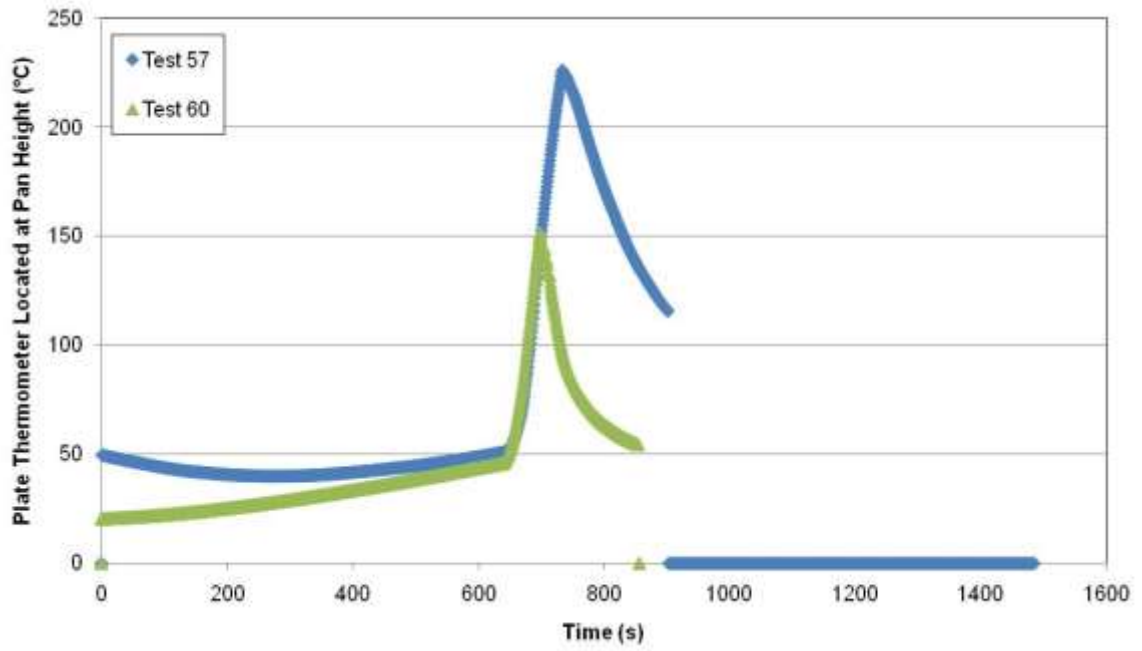

(a)

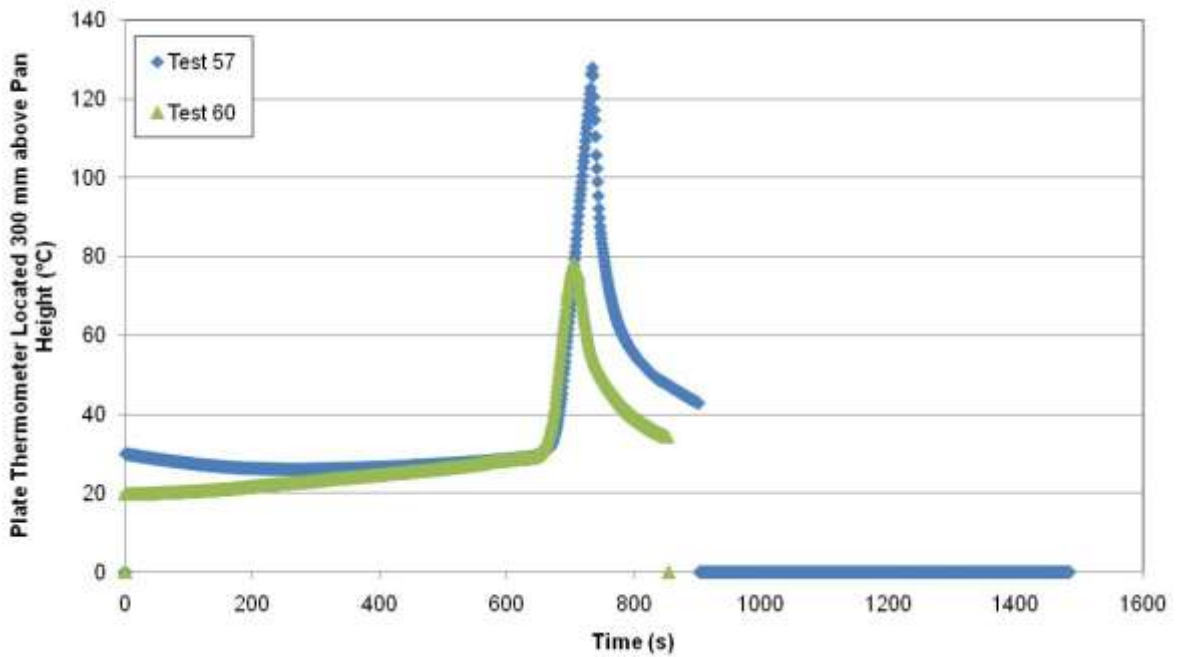

(b)

Figure 98: Plate thermometer temperature measurements for (a) at the height of the lip of the skillet, and (b) 300 mm above the lip of the skillet for Tests 56 and 60.

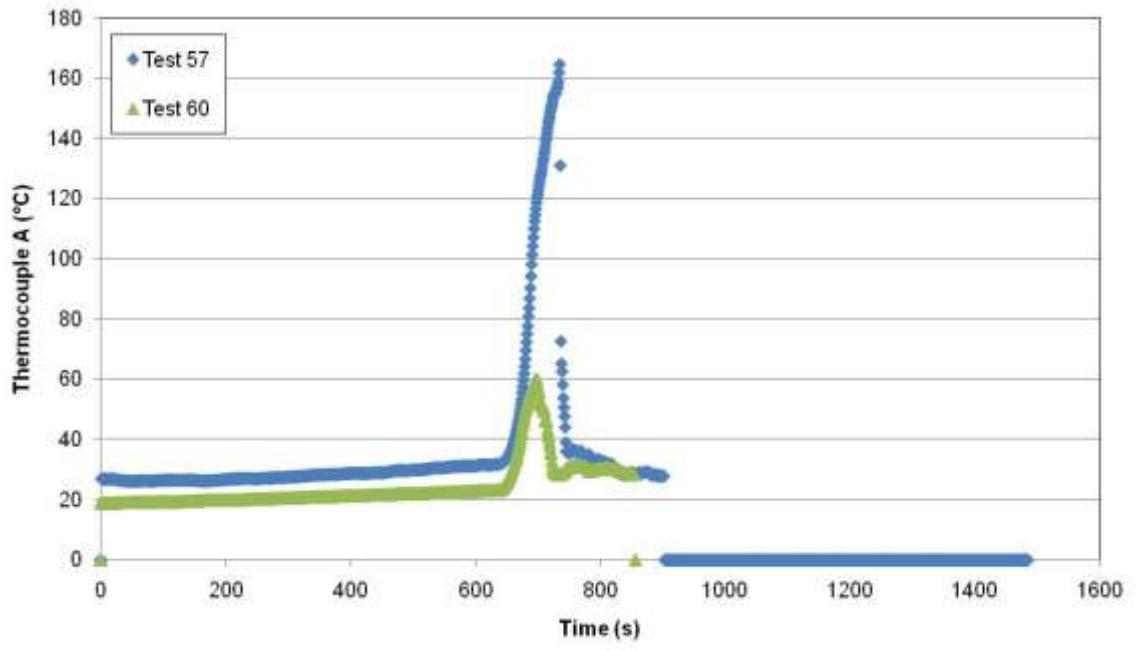

(a)

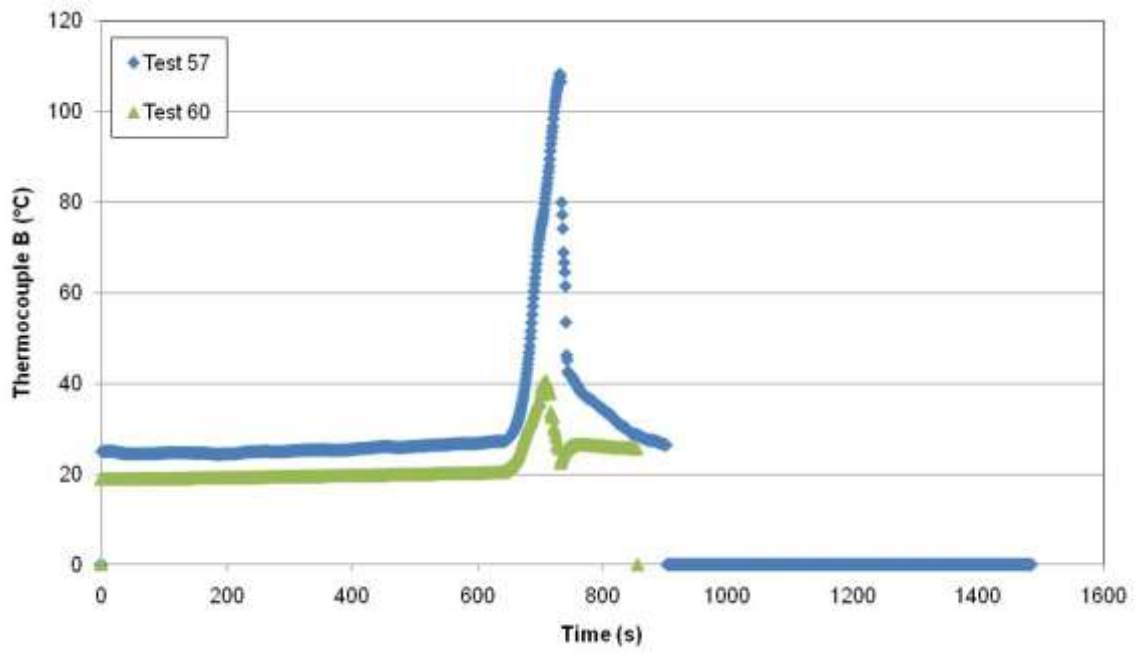

(b)

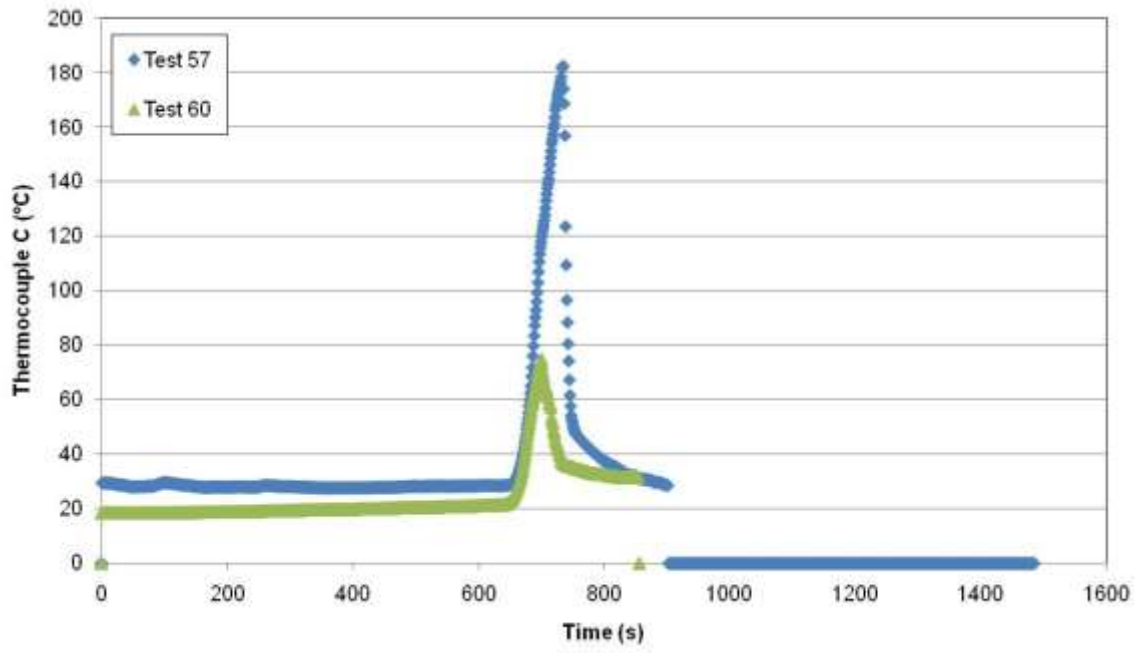

(c)

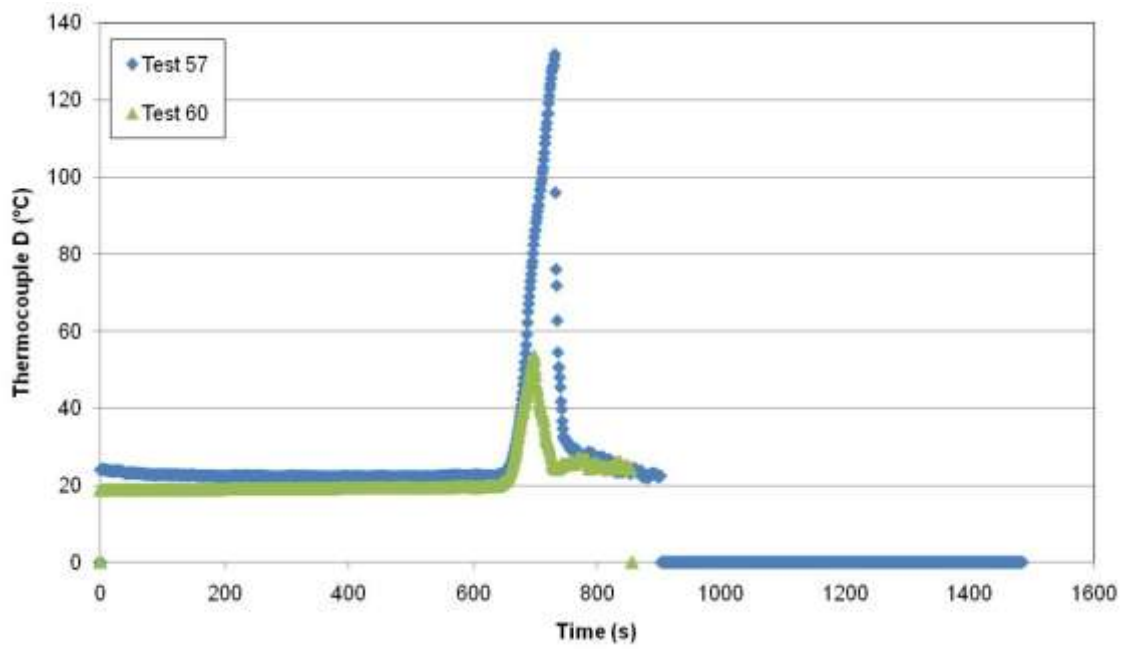

(d)

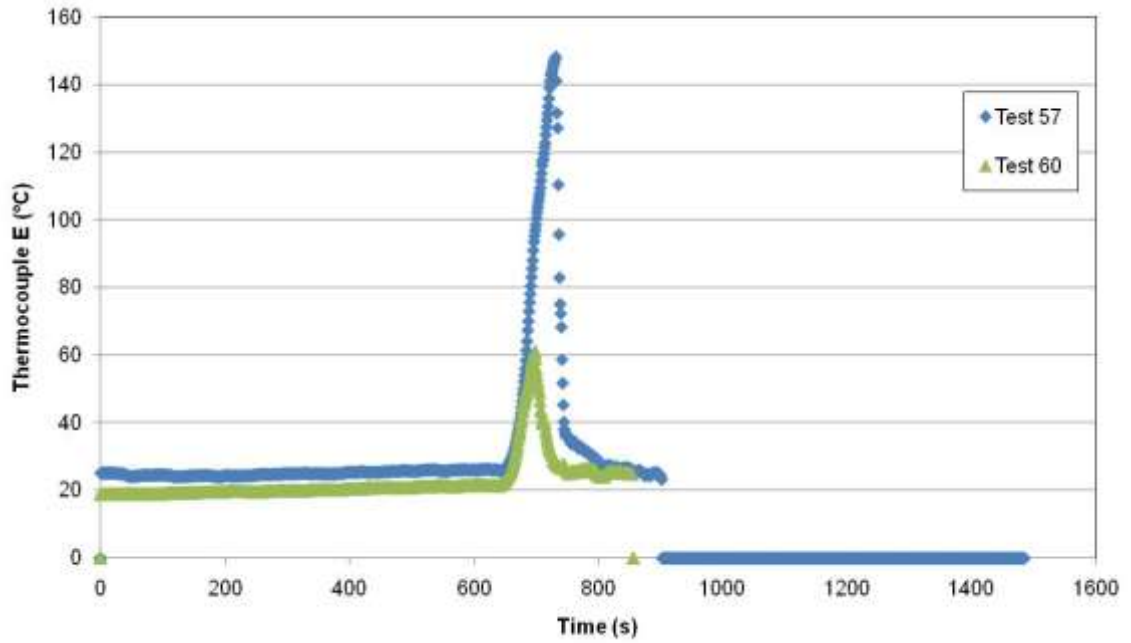

(e)

Figure 99: Thermocouple measurements of (a) thermocouple A, (b) thermocouple B, (c) thermocouple C, (d) thermocouple D, and (e) thermocouple E for Tests 56 and 60.

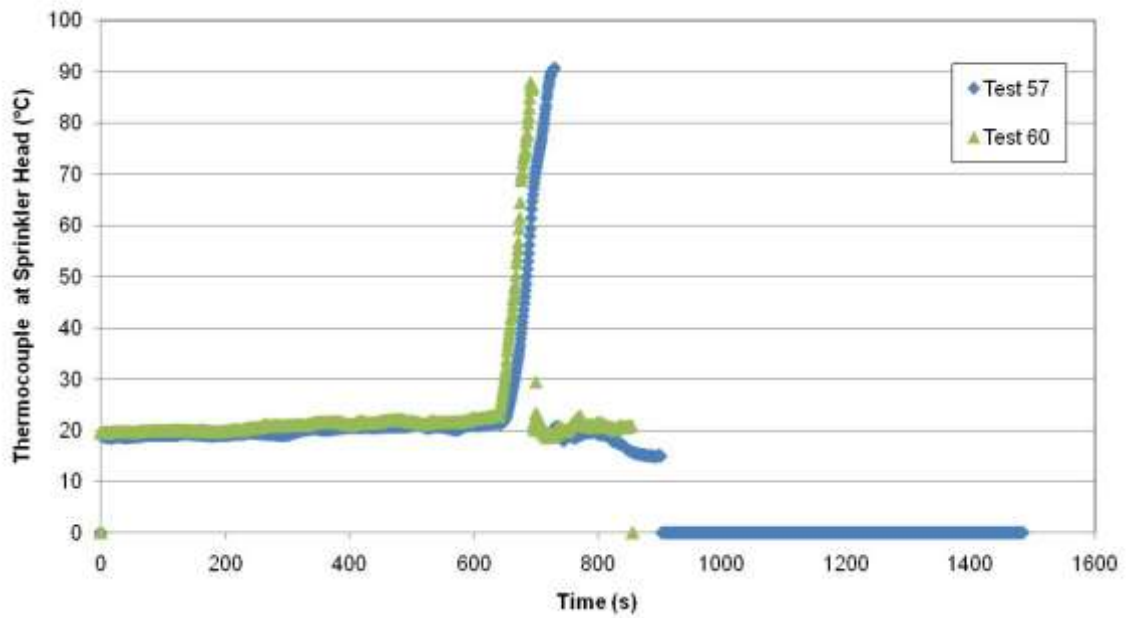

(a)

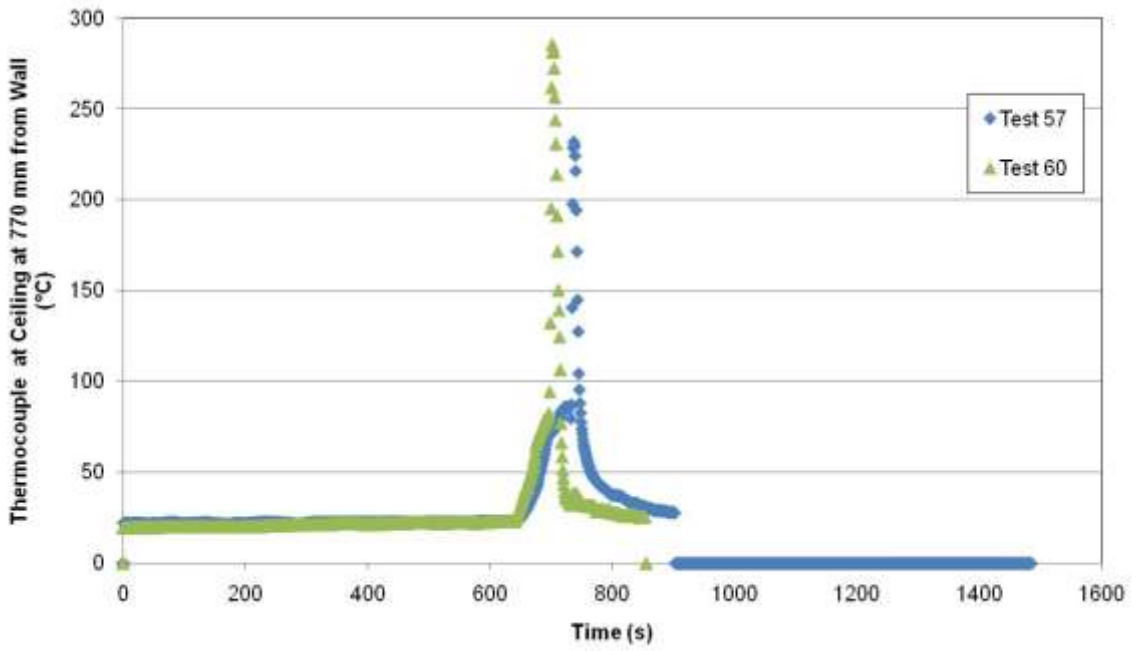

(b)

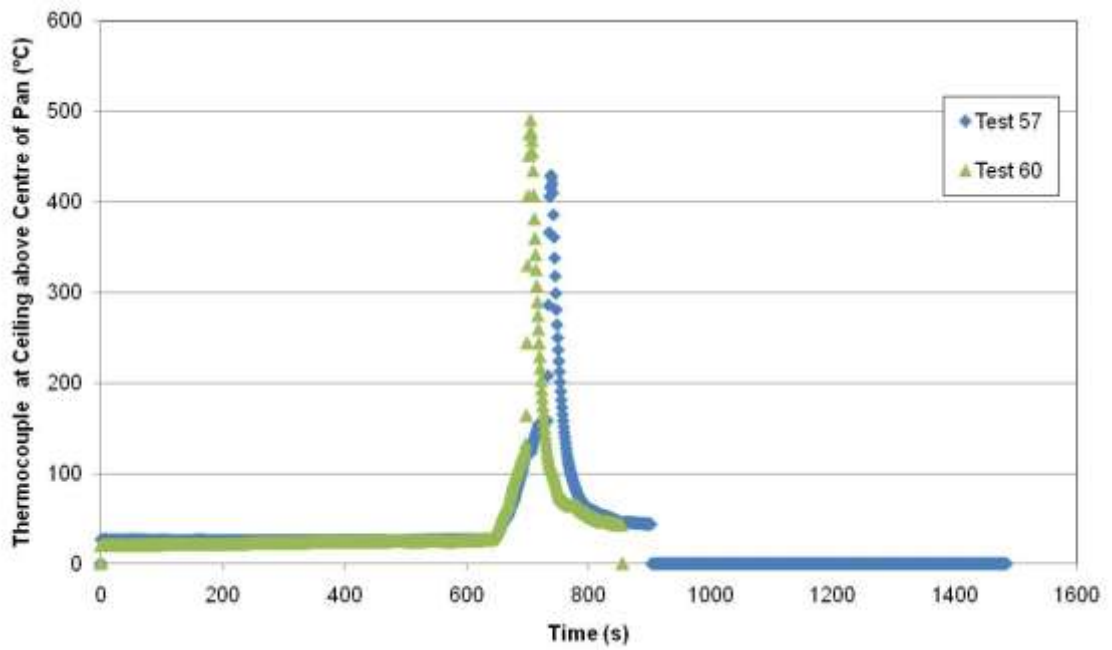

(c)

Figure 100: Thermocouple measurements at the ceiling (a) 1500 mm from the wall and centred in the corridor (at the sprinkler head), (b) 770 mm from the wall and centred in the corridor, and (b) directly above the centre of the skillet for Tests 56 and 60.

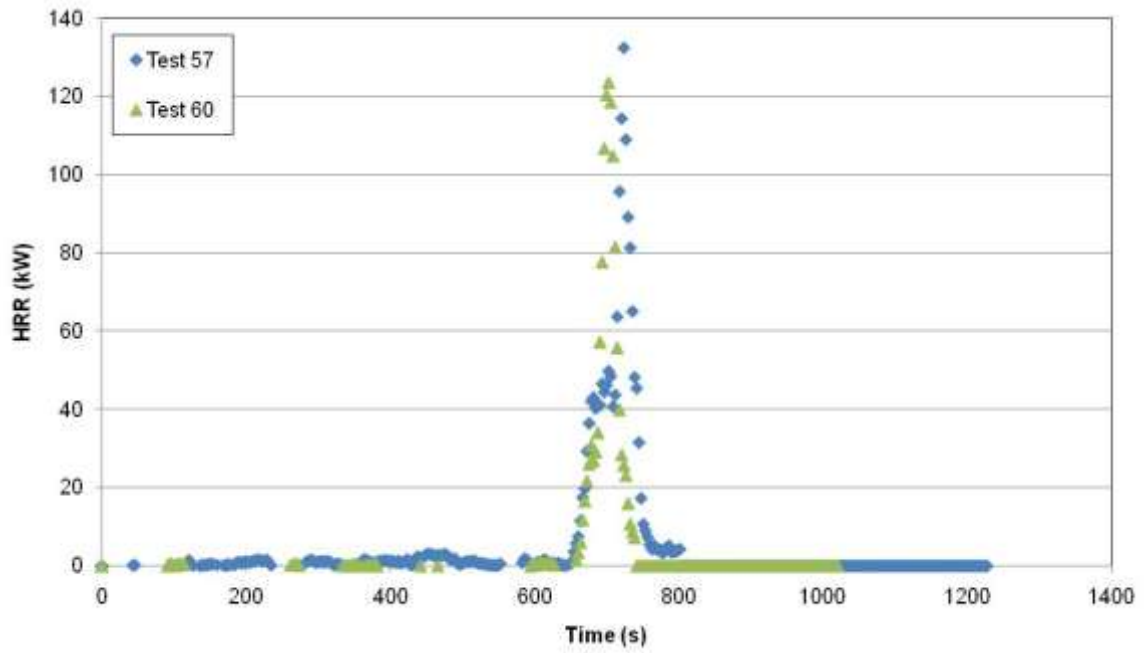
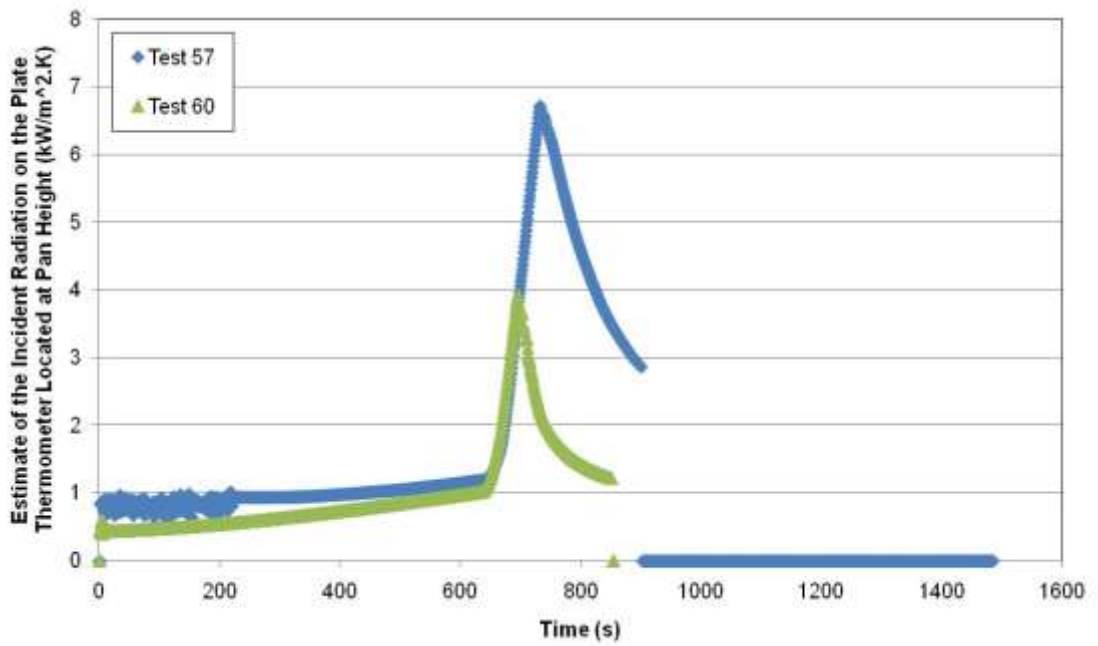
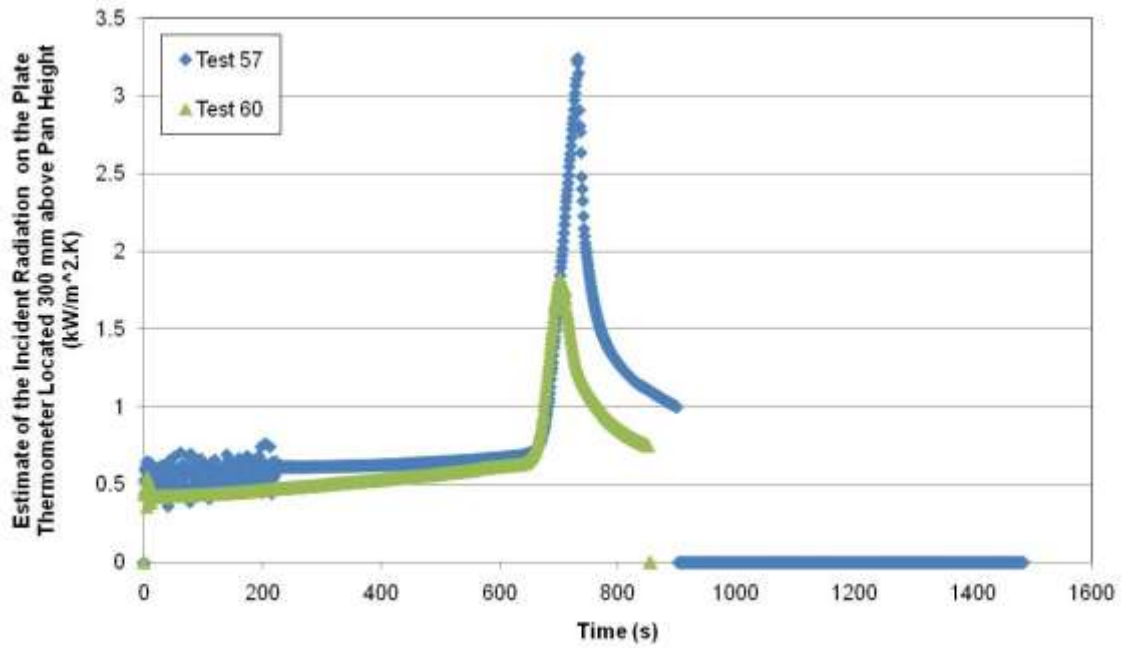

Figure 101: Heat release rates estimated from oxygen calorimetry for Tests 56 and 60.

4.15.1 Analysis



(a)



(b)

Figure 102: Estimates of the incident radiation on the plate thermometer (a) at the height of the lip of the skillet, and (b) 300 mm above the lip of the skillet for Tests 56 and 60.

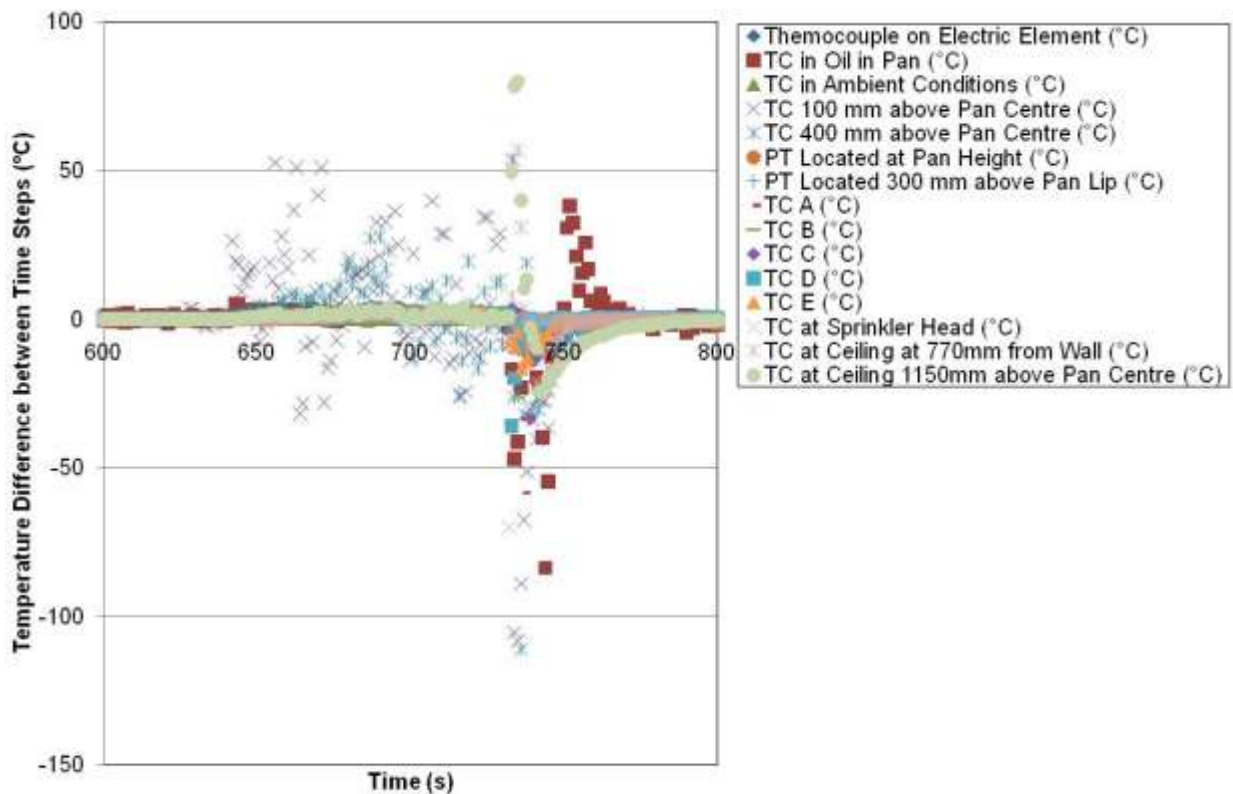

Figure 103: An example of differences of each of the variable temperatures to between sequential time steps for Test 57.

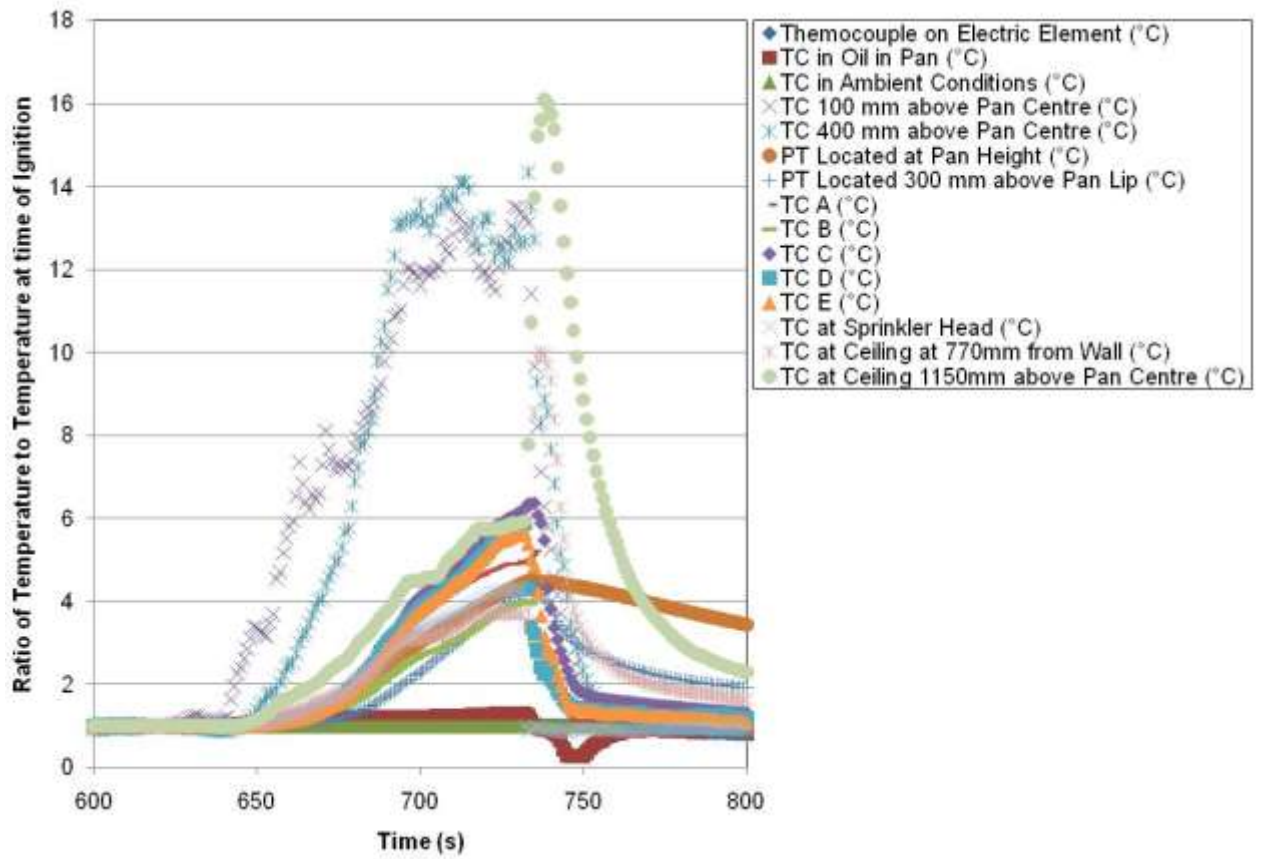

Figure 104: An example of ratios of each of the variable temperatures to the temperatures at the time of ignition for Test 57.

4.16 Skillet with 400 ml Canola Oil, Fan, Single Automatic Sprinkler Head (Test 70)

This test involved an electric stove-top against a wall in a corridor section under the furniture calorimeter hood with the fan turned on. The skillet, containing 400 ml of canola oil, was present on the powered electric element. A single residential pendant sprinkler head was located 1500 mm from the wall behind the electric stove-top and located centrally in the width of the corridor. This test provided a comparison to the tests where 200 ml of canola oil was present and was protected by a single sprinkler head (Section 0). The measured temperatures are shown in Figure 105. Estimates of the incident radiation on the plate thermometers is shown in Figure 109. Differences between time step measurements of each of the temperatures are shown in Figure 110. Ratios of each of the variable temperatures to the temperatures at the time of ignition are shown in Figure 111.

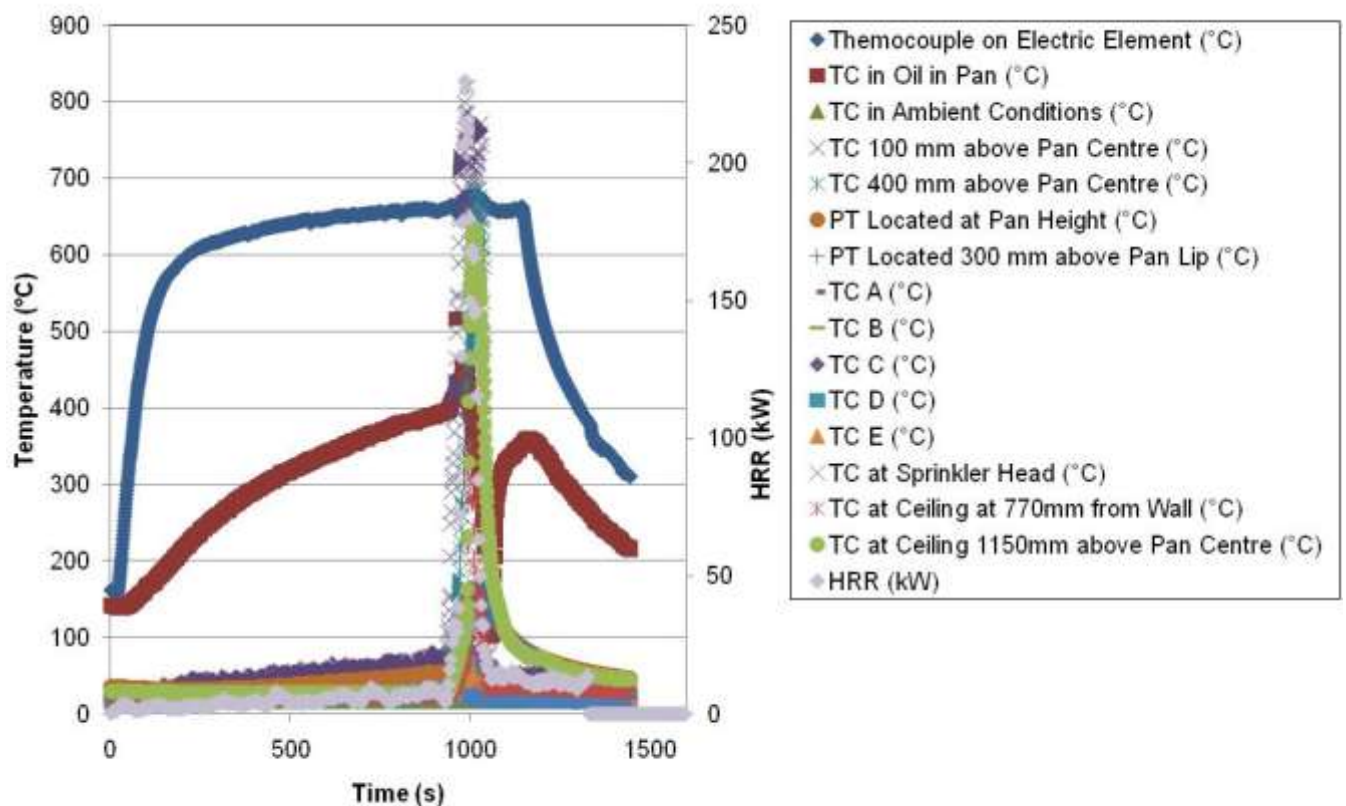

Figure 105: Measured temperatures of the thermocouples and plate thermometers for a skillet containing 400 ml canola oil on an electric stove-top against a wall in a partial corridor with the furniture calorimeter fan running and protected by a single sprinkler head (Test 70).

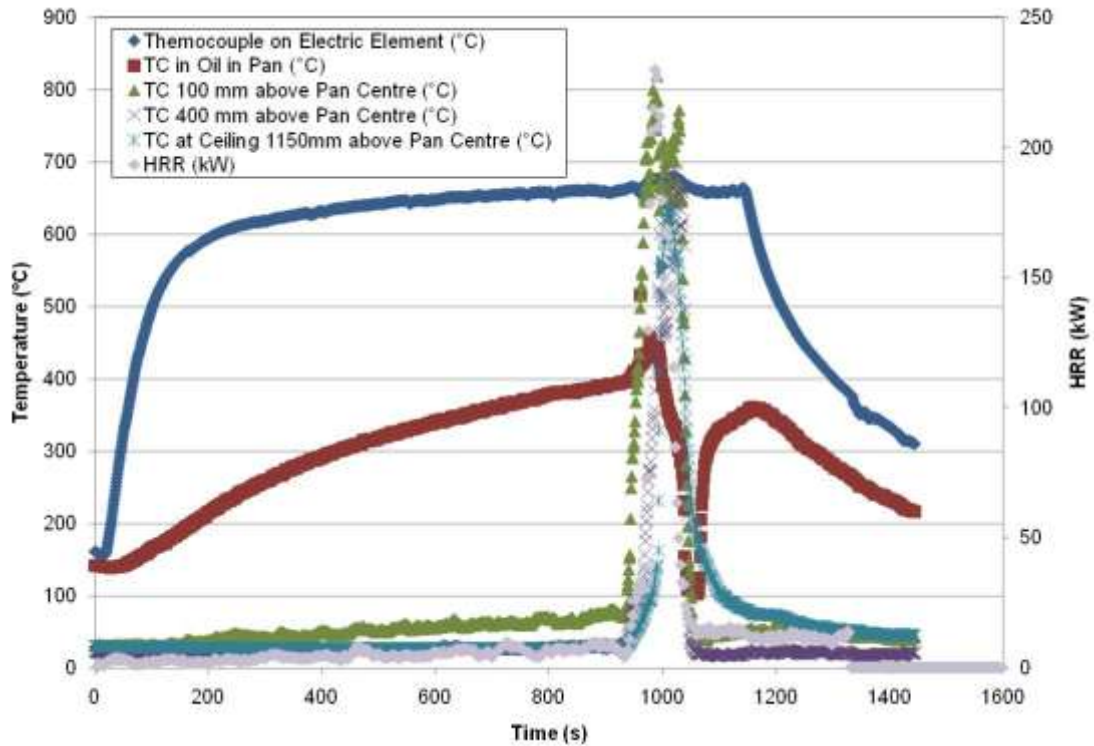

Figure 106: Measured temperatures of the thermocouples in a vertical line above the centre of the heating element for a skillet containing 400 ml canola oil on an electric stove-top against a wall in a partial corridor with the furniture calorimeter fan running and protected by a single sprinkler head (Test 70).

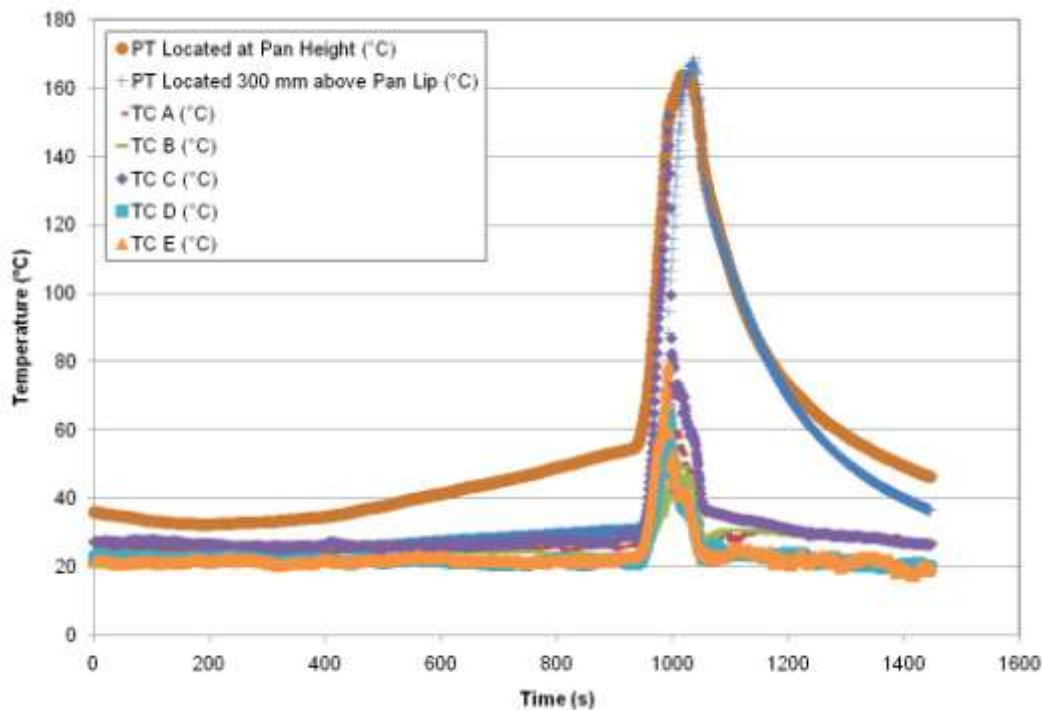

Figure 107: Measured temperatures of the thermocouples on the stove-top surface (A-E) and plate thermometers for a skillet containing 400 ml canola oil on an electric stove-top against a wall in a partial corridor with the furniture calorimeter fan running and protected by a single sprinkler head (Test 70).

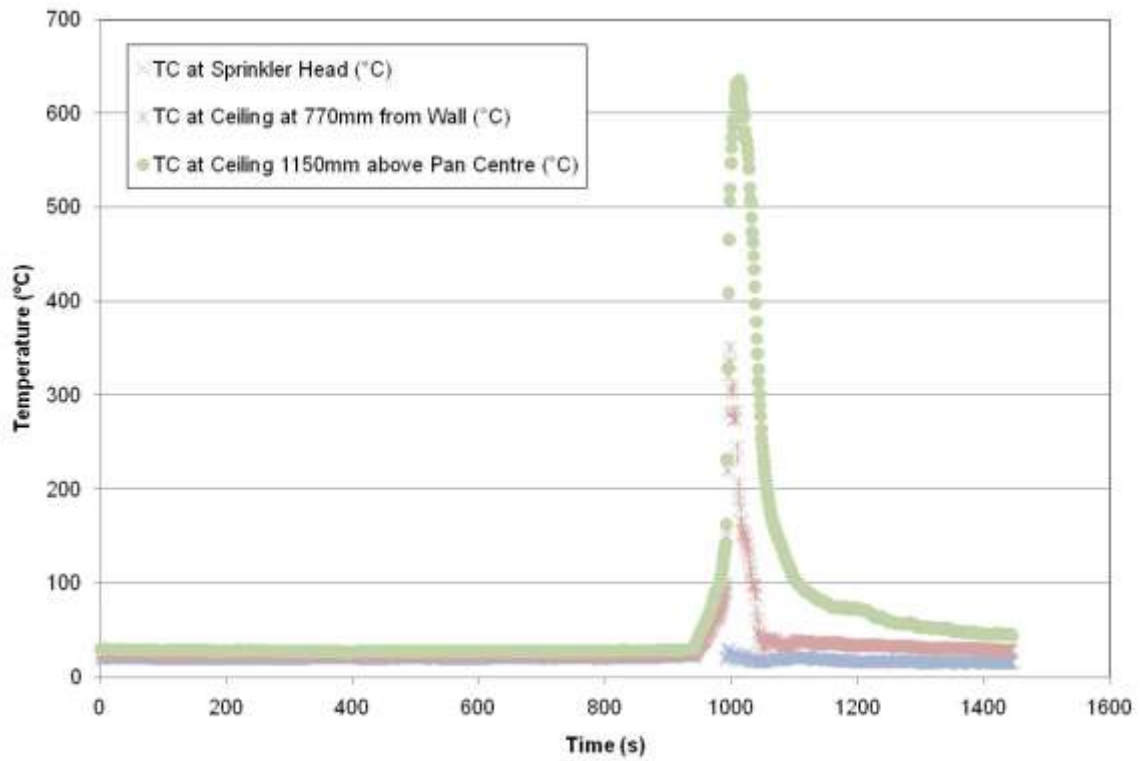

Figure 108: Measured temperatures of the thermocouples at the ceiling of the partial corridor for a skillet containing 400 ml canola oil on an electric stove-top against a wall in a partial corridor with the furniture calorimeter fan running and protected by a single sprinkler head (Test 70).

4.16.1 Analysis

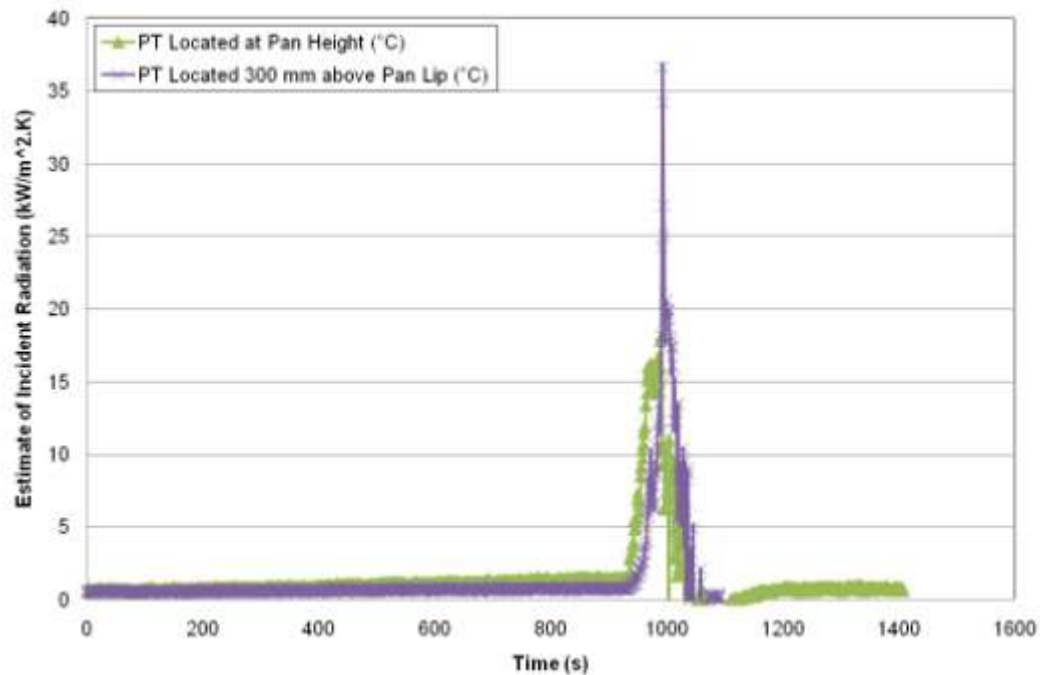

Figure 109: Estimates of the incident radiation for the plate thermometers located 50 mm and 350 mm above the surface of the stove-top for a skillet containing 400 ml canola oil on an electric stove-top against a wall in a partial corridor with the furniture calorimeter fan running and protected by a single sprinkler head (Test 70).

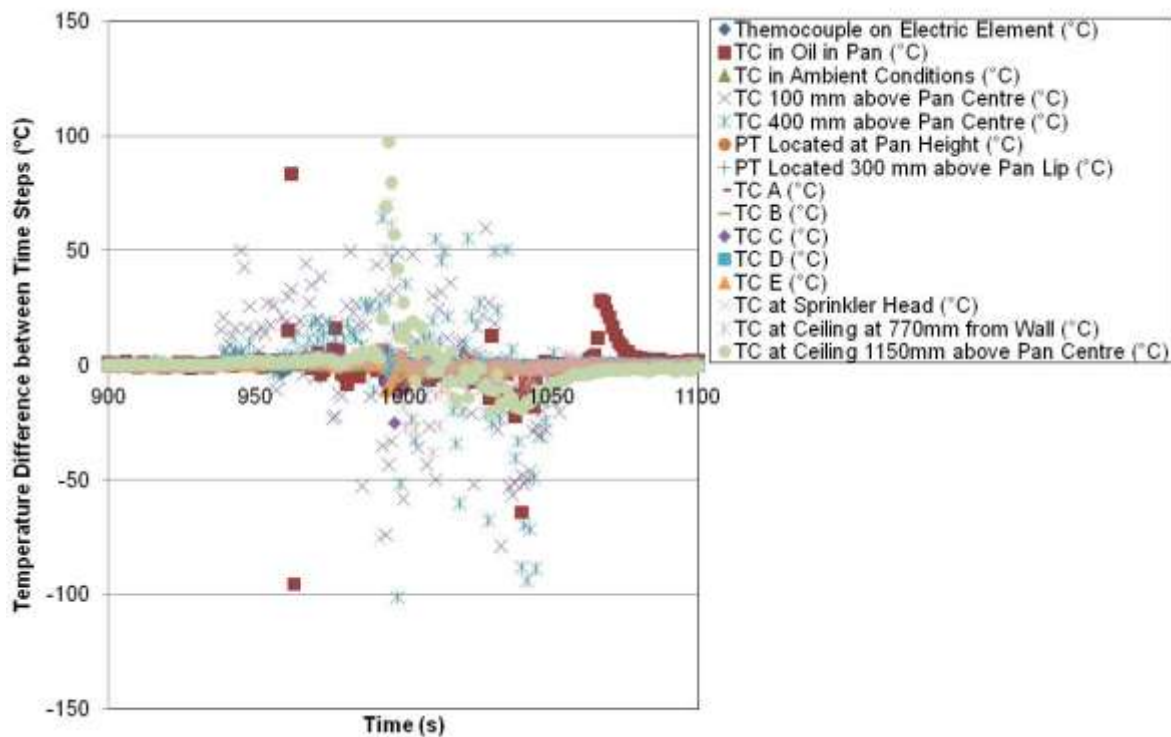

Figure 110: Differences of each of the variable temperatures to between sequential time steps for a skillet containing 400 ml canola oil on an electric stove-top against a wall in a partial corridor with the furniture calorimeter fan running and protected by a single sprinkler head (Test 70).

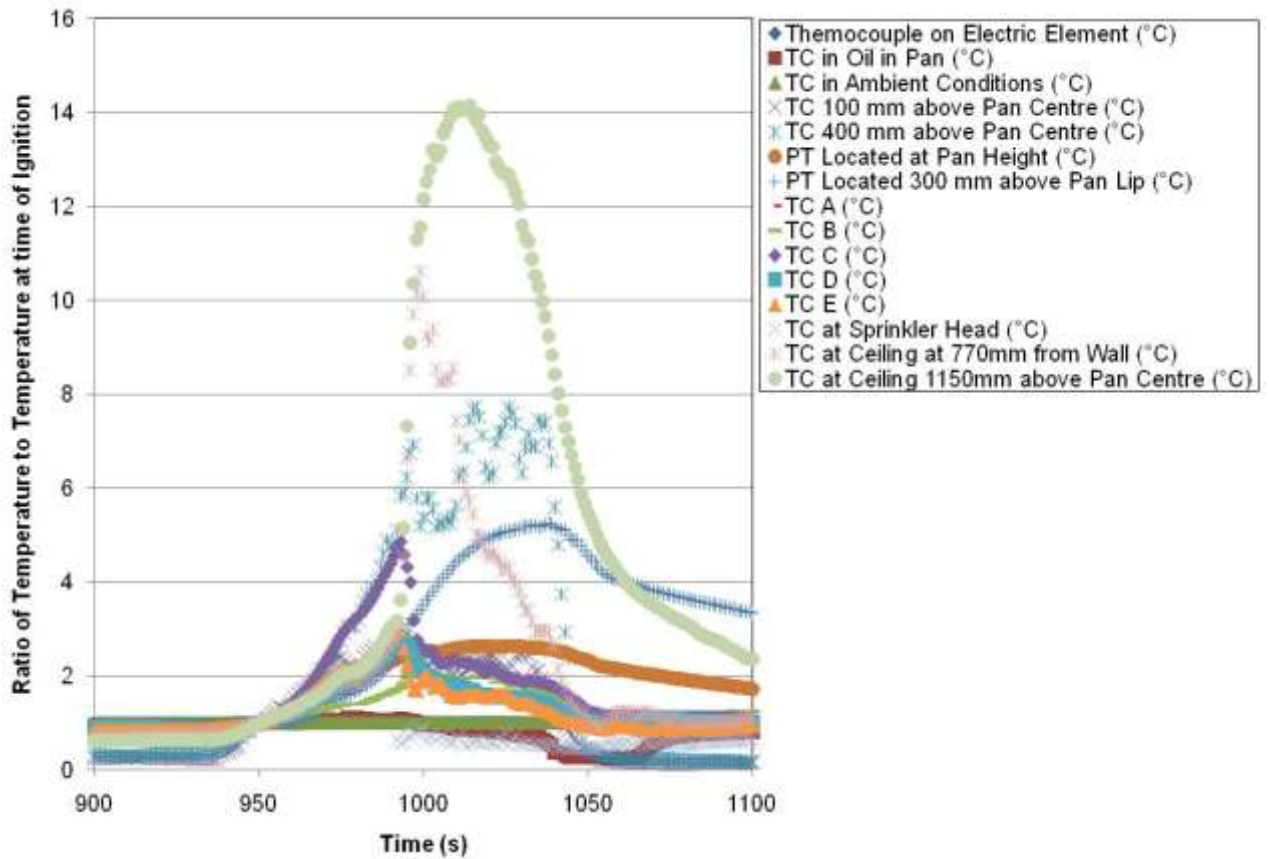
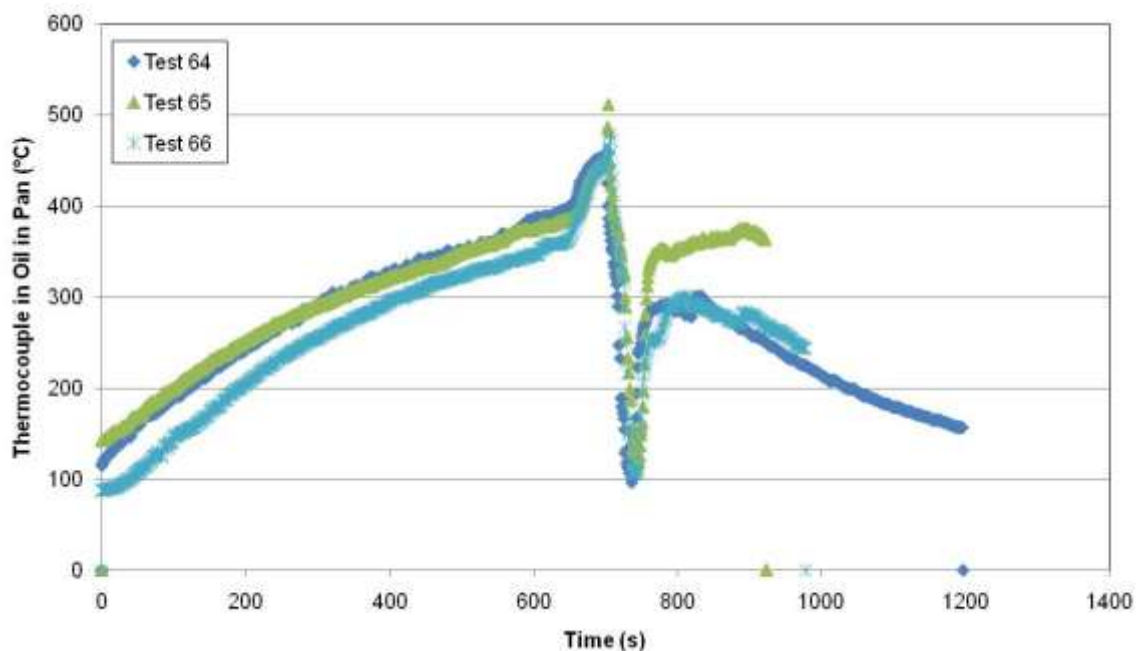

Figure 111: Ratios of each of the variable temperatures to the temperatures at the time of ignition for a skillet containing 400 ml canola oil on an electric stove-top against a wall in a partial corridor with the furniture calorimeter fan running and protected by a single sprinkler head (Test 70).

4.17 Skillet with 200 ml Canola Oil, No Fan, Single Automatic Sprinkler Head (Tests 64 – 66)

This test was an electric stove-top against a wall in the partial corridor under the furniture calorimeter hood with the fan turned off. A single residential sprinkler head was located 1500 mm from the wall and centrally in the width of the partial corridor. The water supply to the sprinkler head was turned on before the start of the test and manually turned off after flameout was observed for each test. The skillet, with 200 ml of canola oil, was present on the powered electric element. This test formed a comparison to the results for the setup with a stove-top against a wall in the partial corridor and flaming 200 ml canola oil with the extraction fan running with a single residential fire sprinkler present (e.g. Section 4.16) and tests where types of fire suppression were applied (e.g. Sections 4.12 - 4.14). Tests 64 to 66 are examples of this scenario.

The thermocouple measurements in the oil and above the centre of the pan are shown in Figure 112. Plate thermometer temperature measurements are shown in Figure 113. Thermocouple measurements for locations on the surface of the stove-top are shown in Figure 114. Thermocouple measurements for locations on the ceiling of the partial corridor are shown in Figure 115. Estimates of the incident radiation on the plate thermometers are shown in Figure 116. An example of the temperature differences between sequential time steps for each of the variables recorded is shown in Figure 117 for Test 64 (where the time shown is based on the original test data, as included in Appendices C and D). An example of the ratios of temperatures to the temperature at the time of ignition for each of the variables recorded is shown in Figure 118 for Test 64 (where the time shown is based on the original test data, as included in Appendices C and D).



(a)

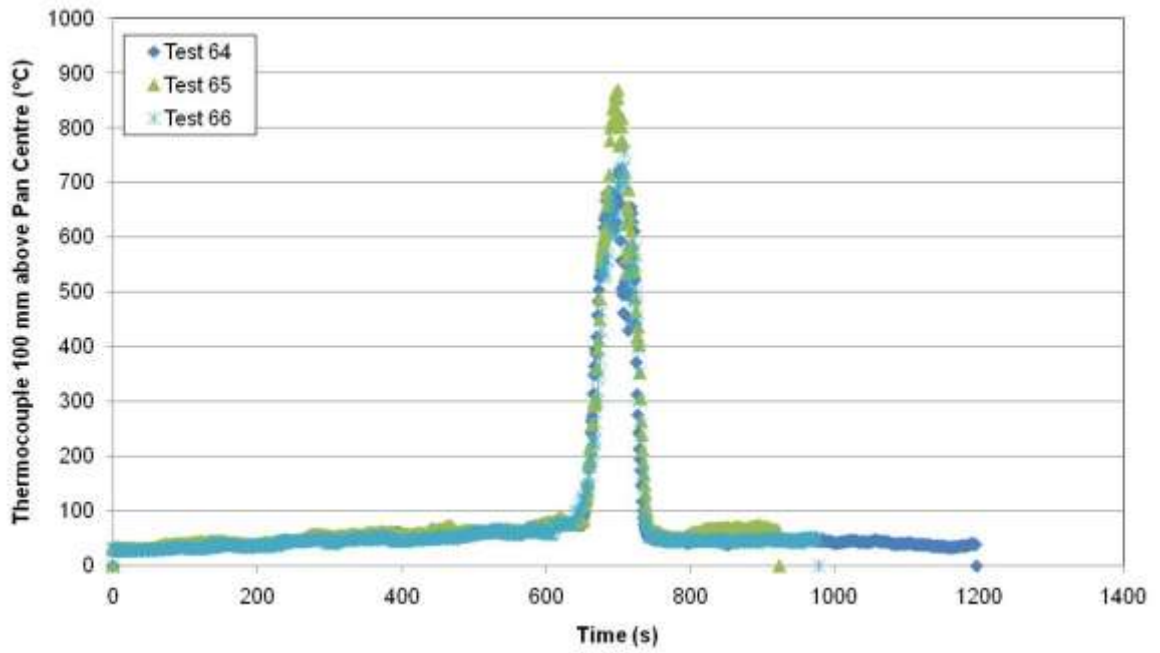

(b)

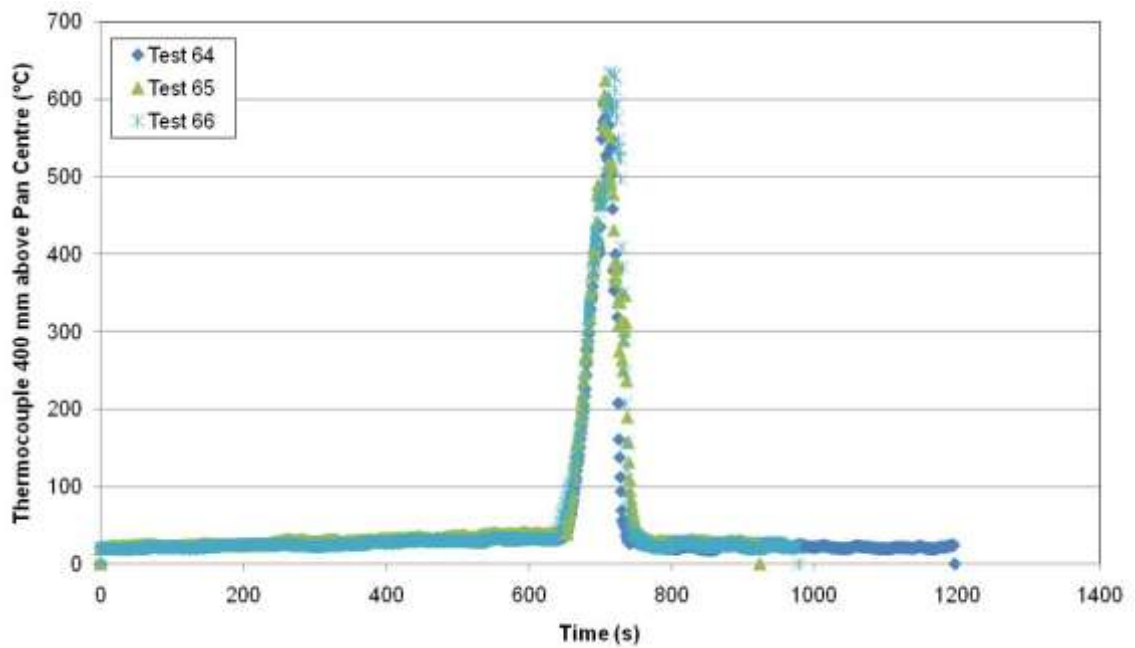

(c)

Figure 112: Thermocouple measurements for the thermocouple located (a) in the oil in the skillet, (b) 100 mm above the centre of the skillet, and (c) 400 mm above the centre of the skillet for Tests 64 – 66.

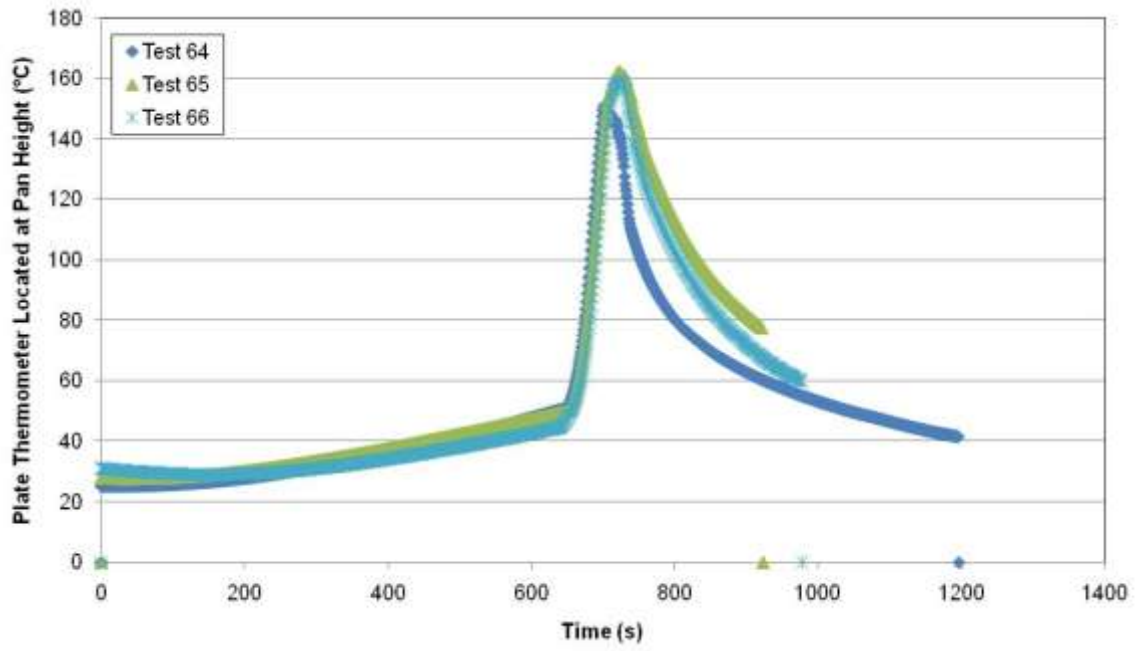

(a)

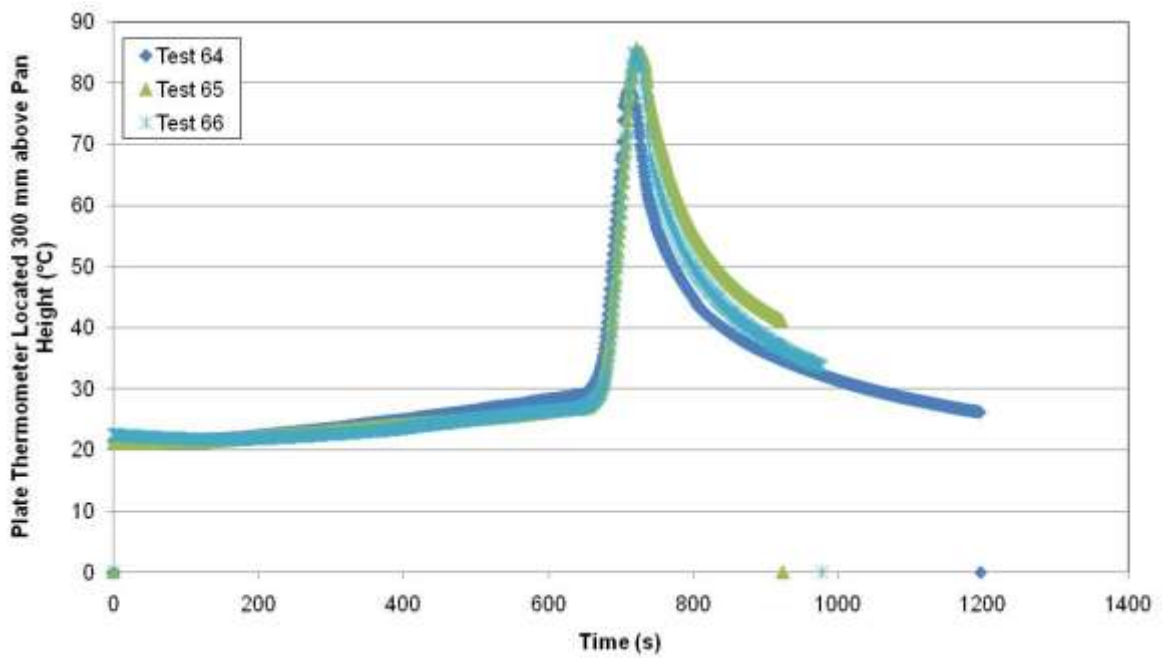

(b)

Figure 113: Plate thermometer temperature measurements for (a) at the height of the lip of the skillet, and (b) 300 mm above the lip of the skillet for Tests 64 – 66.

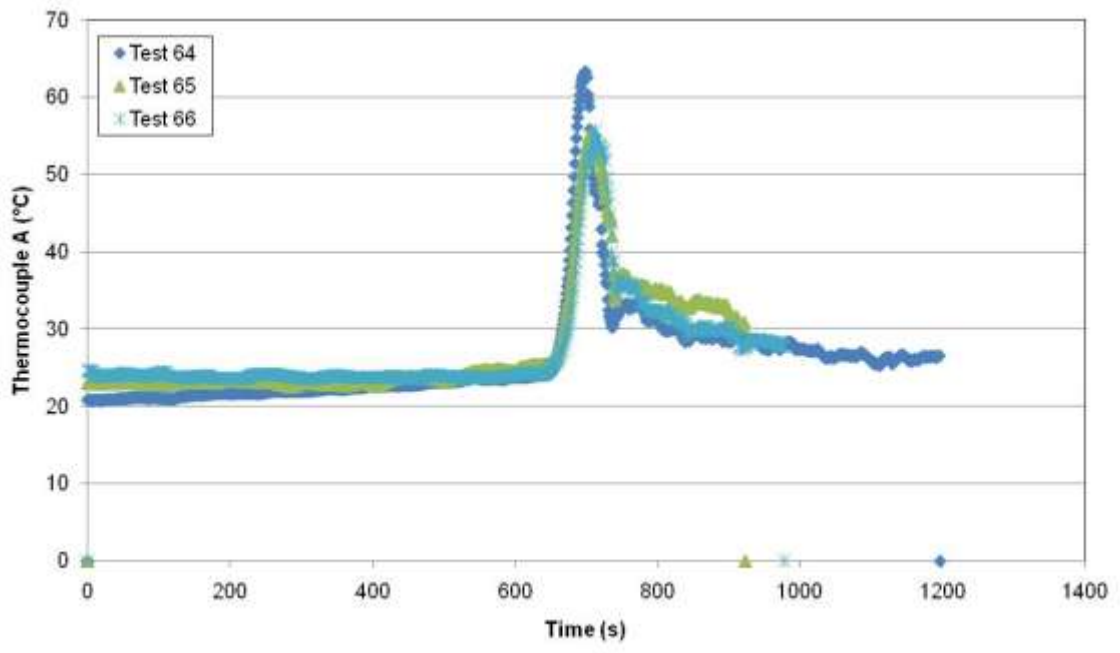

(a)

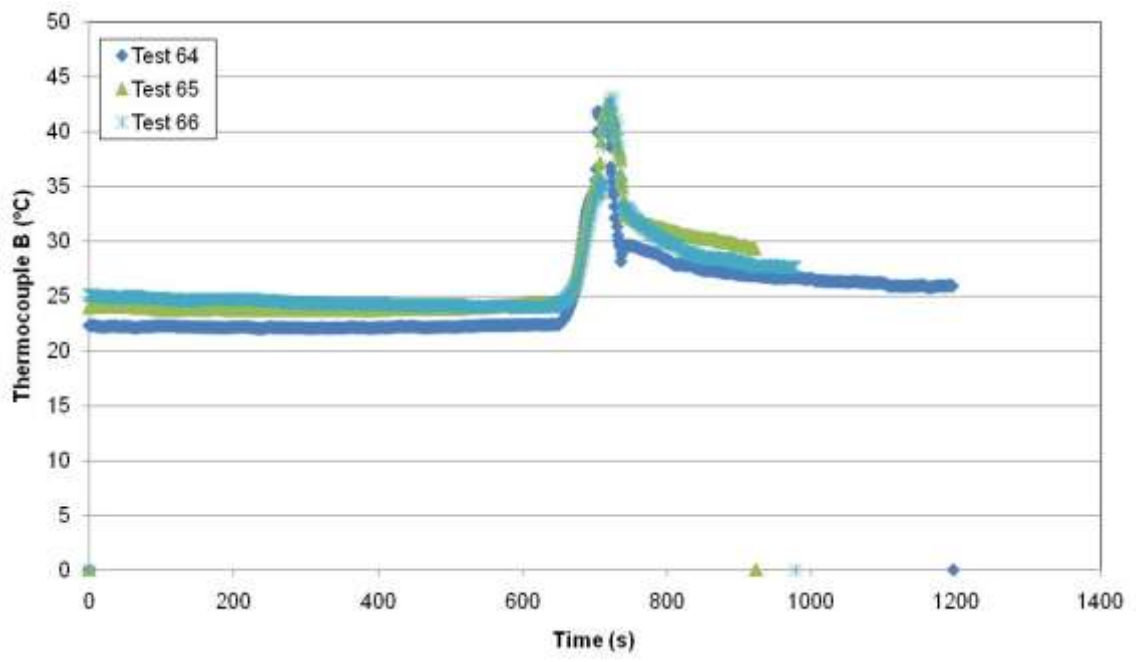

(b)

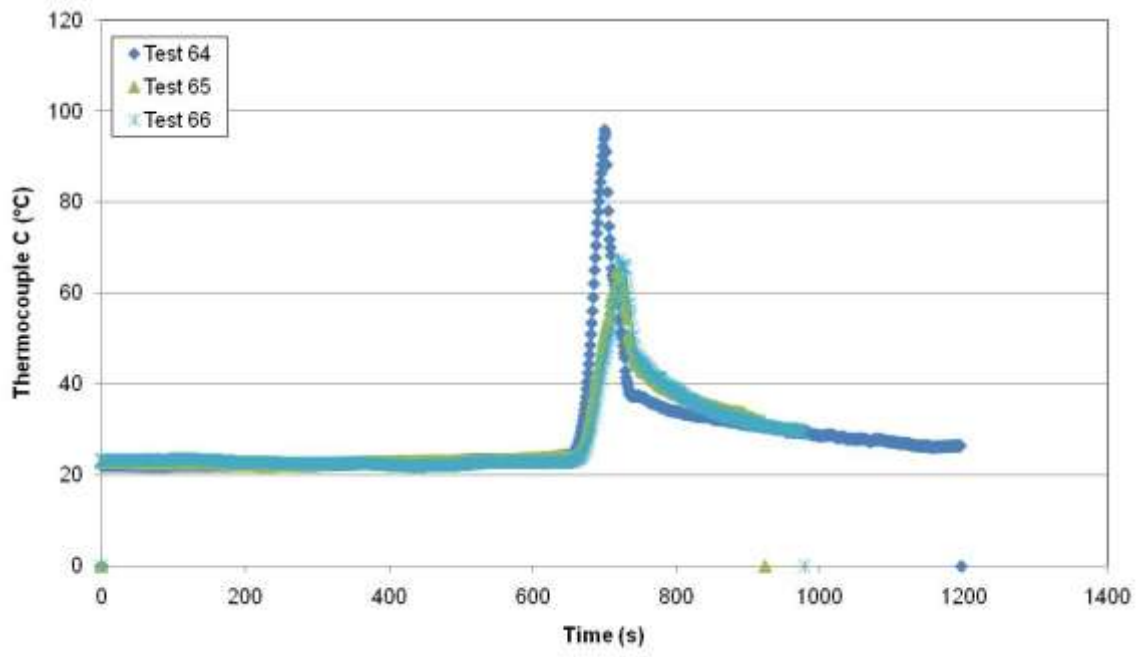

(c)

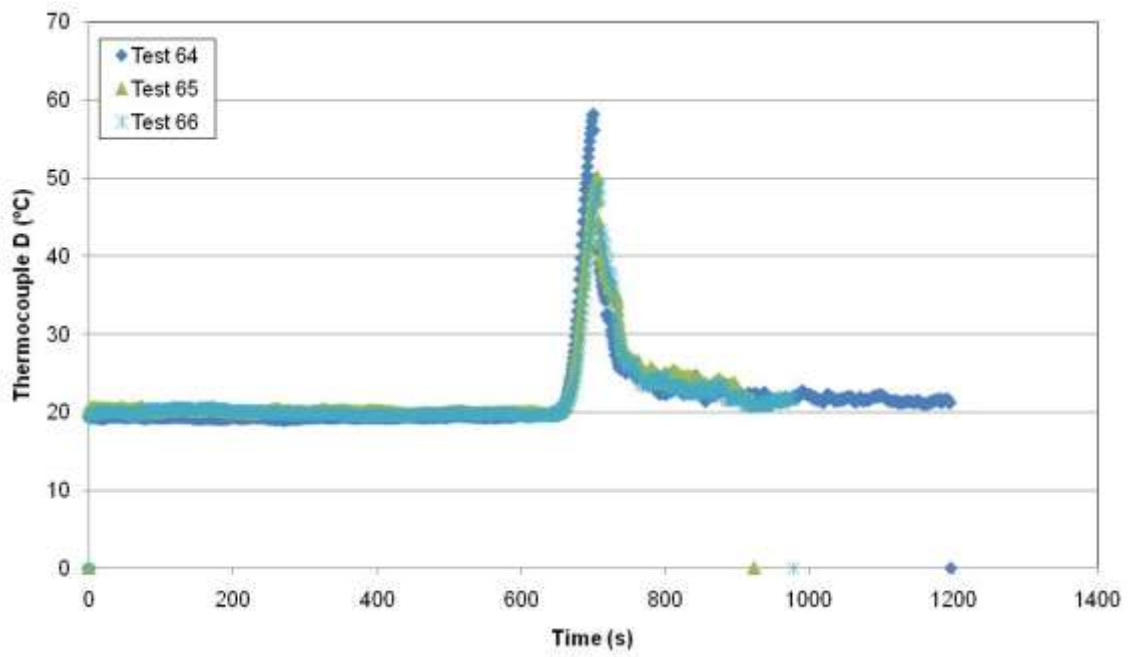

(d)

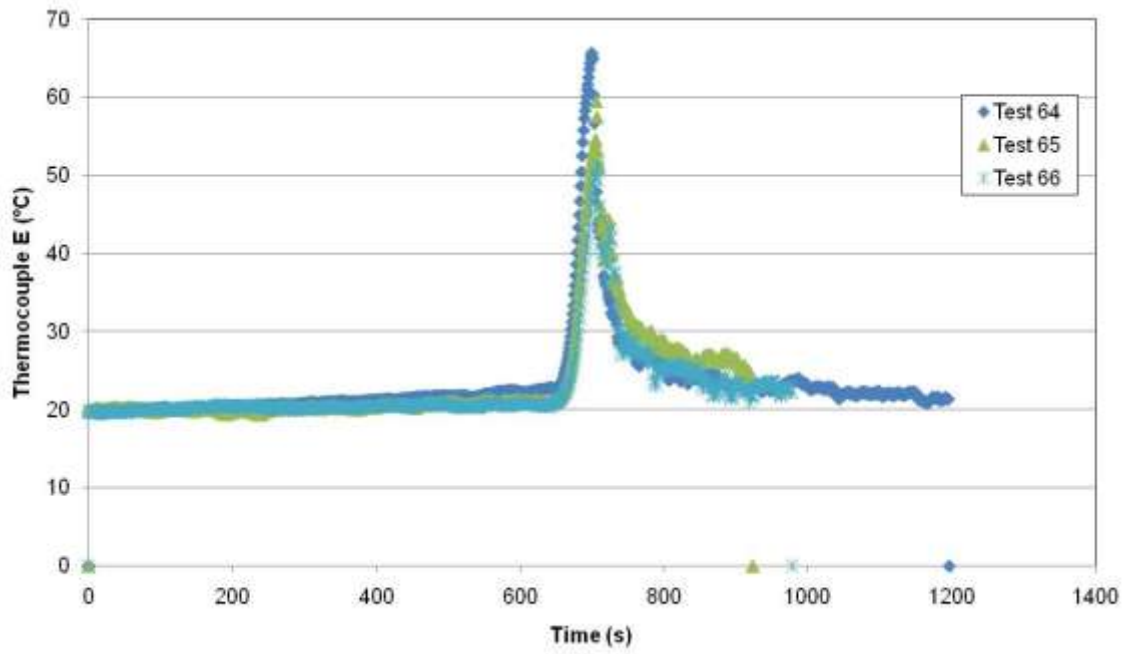

(e)

Figure 114: Thermocouple measurements of (a) thermocouple A, (b) thermocouple B, (c) thermocouple C, (d) thermocouple D, and (e) thermocouple E for Tests 56 and 60.

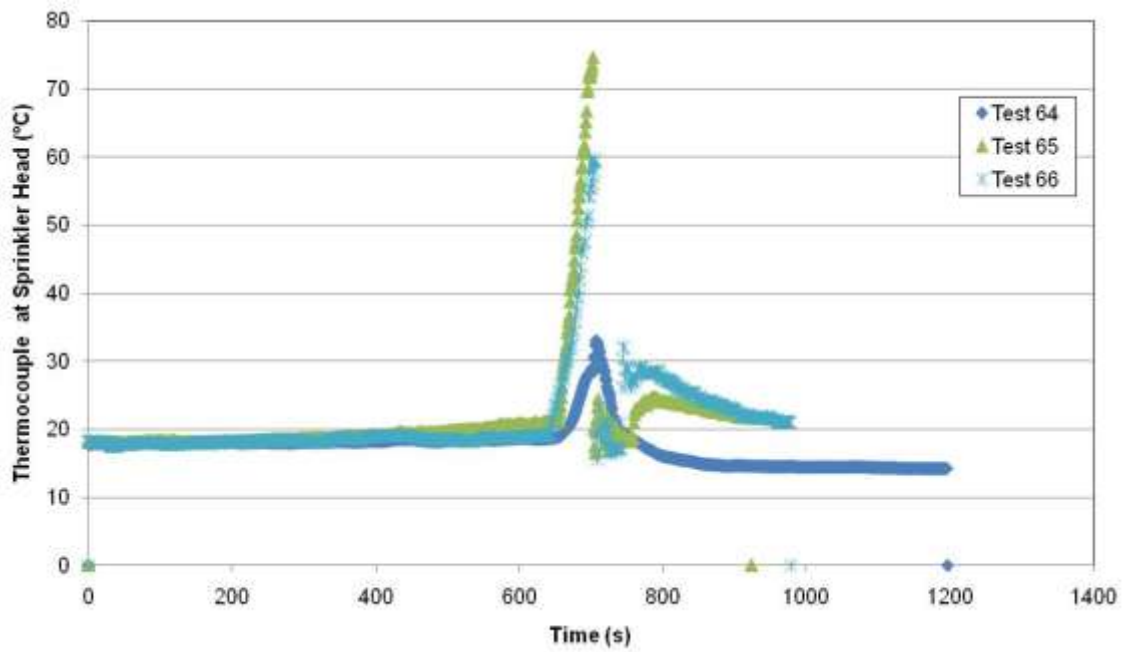

(a)

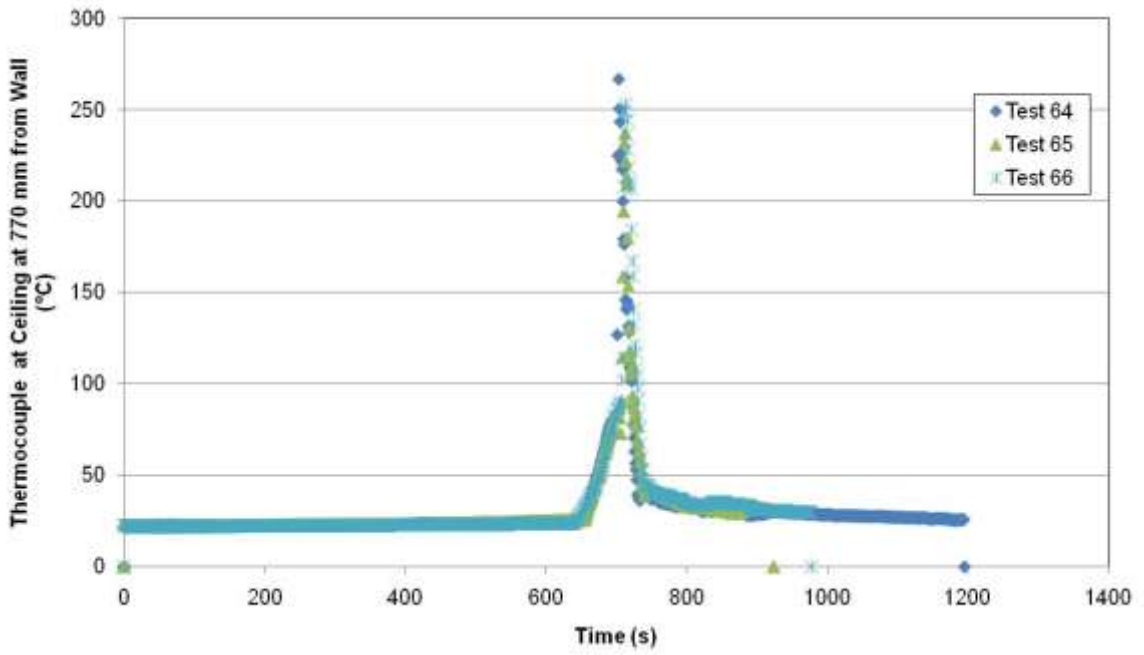

(b)

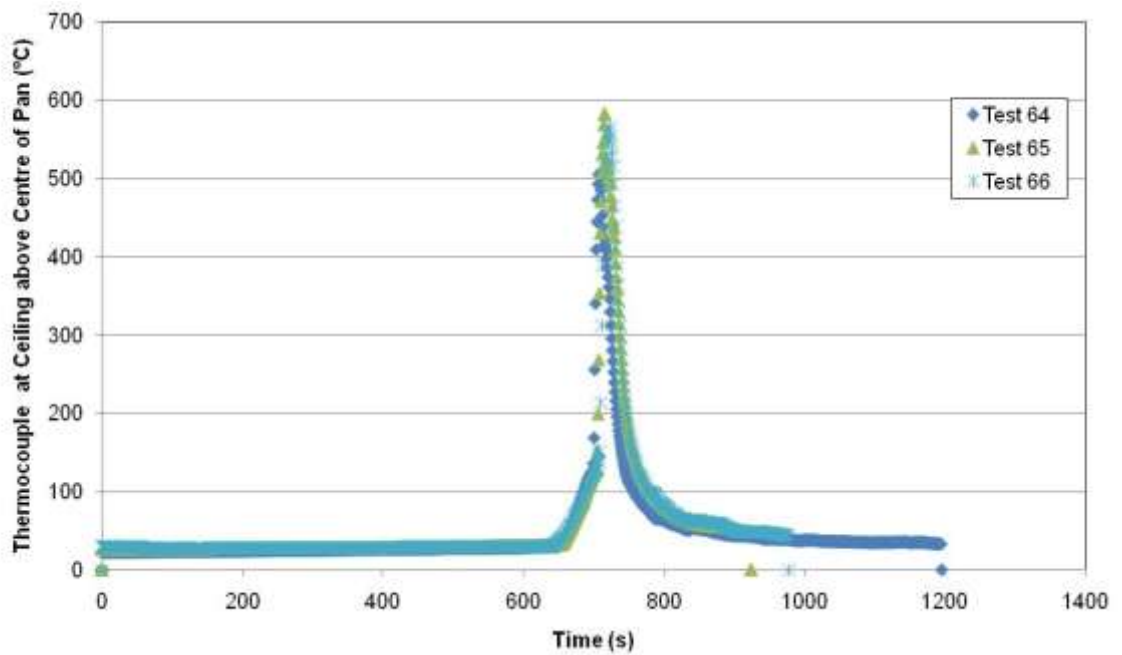

(c)

Figure 115: Thermocouple measurements at the ceiling (a) 1500 mm from the wall and centred in the corridor (at the sprinkler head), (b) 770 mm from the wall and centred in the corridor, and (c) directly above the centre of the skillet for Tests 64 – 66.

4.17.1 Analysis

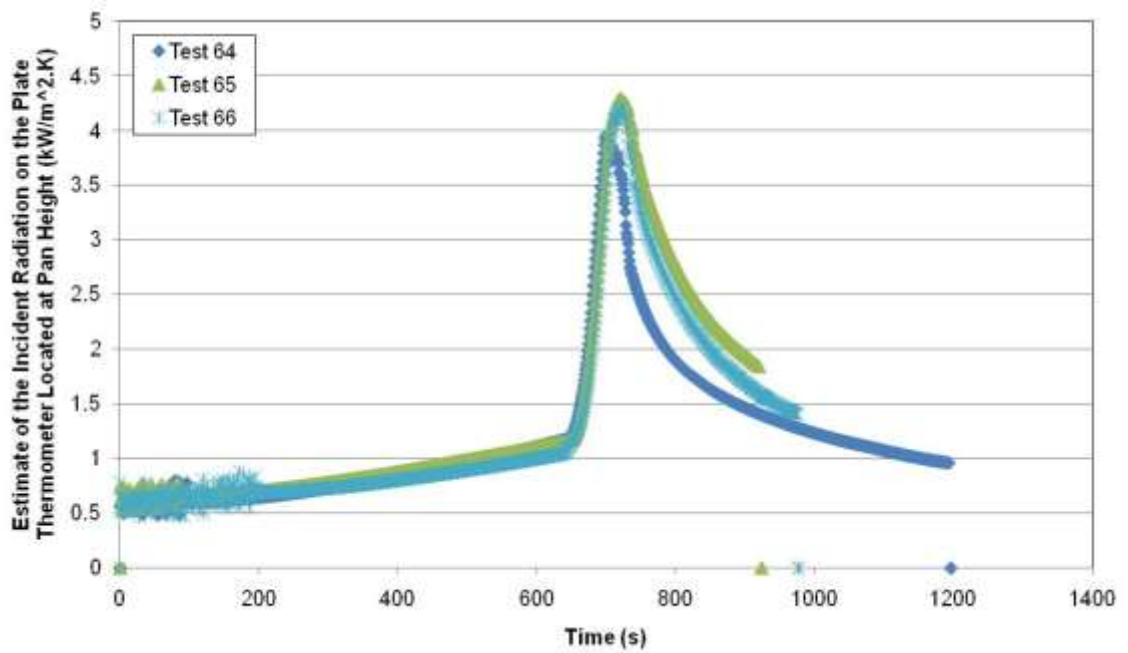

(a)

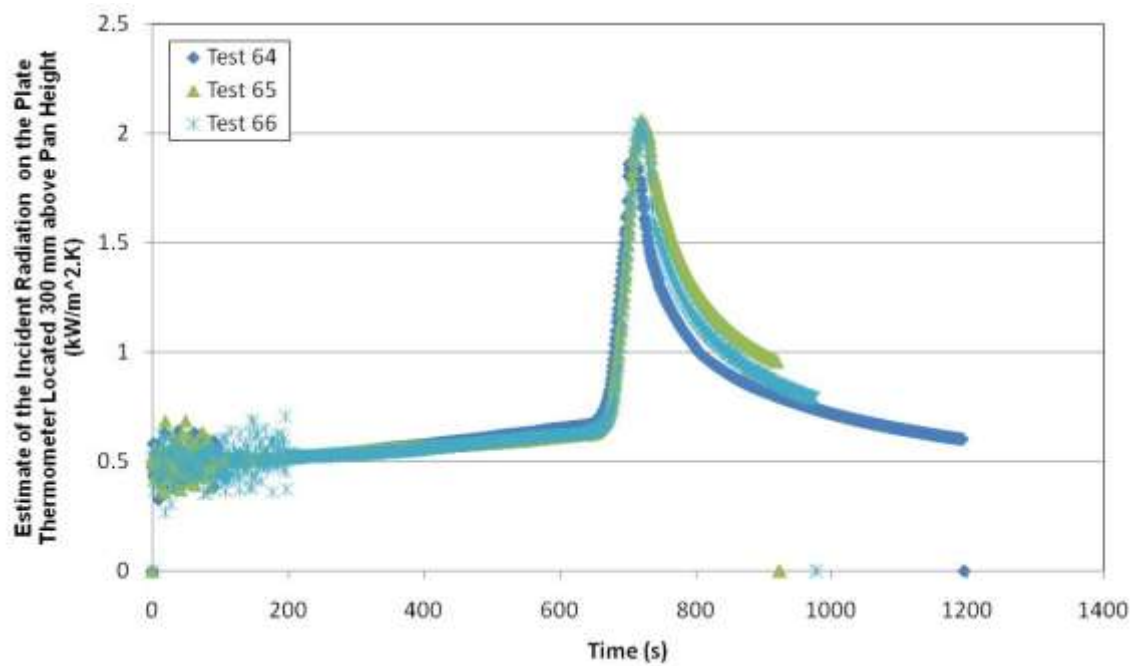

(b)

Figure 116: Estimates of the incident radiation on the plate thermometer (a) at the height of the lip of the skillet, and (b) 300 mm above the lip of the skillet for Tests 64 – 66.

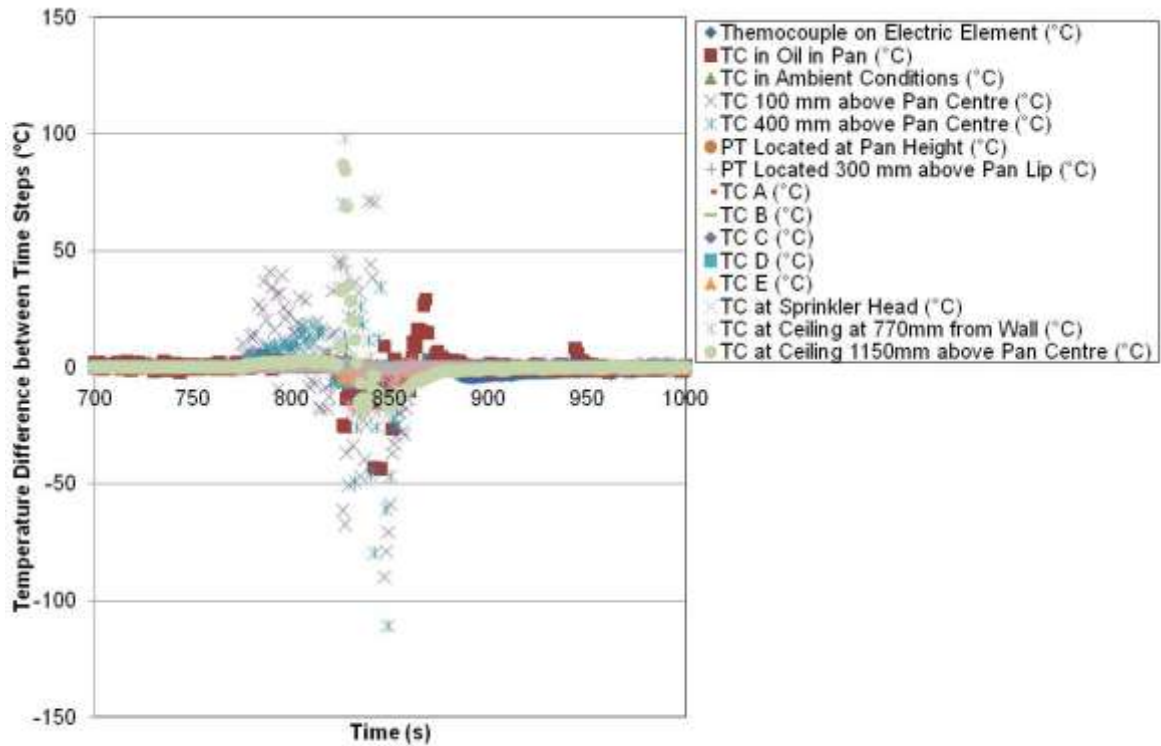

Figure 117: Differences of each of the variable temperatures to between sequential time steps for Test 64.

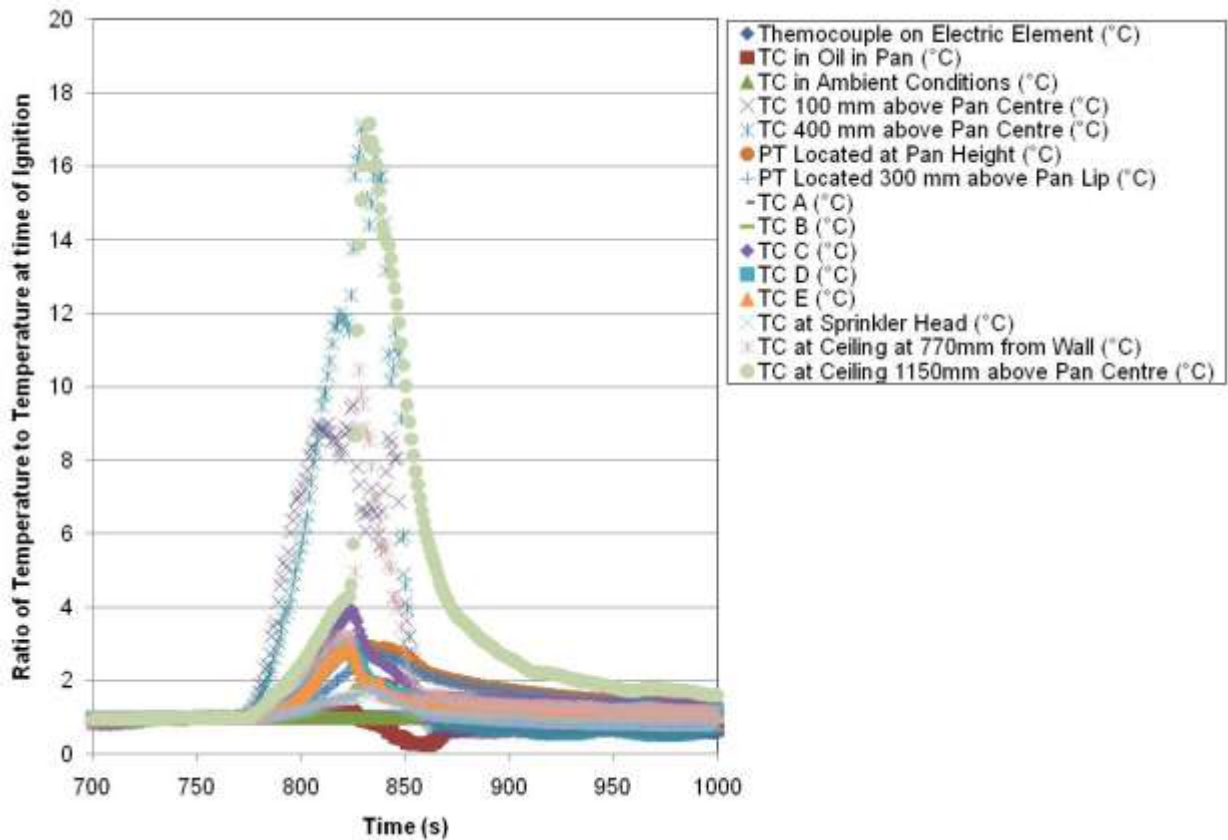

Figure 118: Ratios of each of the variable temperatures to the temperatures at the time of ignition for Test 64.

5. DISCUSSION OF RESULTS

This section is a summary of a general discussion of the repeatability and influence of the experimental parameters on the experiment results. Quantification of fire suppression effectiveness is discussed in the following section (Section 6).

5.1 Repeatability

The repeatability of the free-burning experiments was good. This provides high confidence in a consistent level of challenge available for assessing potential fire protection systems.

There was less, although still reasonable, repeatability associated with the experiments with potential fire protection systems present. This lower repeatability is expected for tests including potential fire protection systems, since the interaction of the active part of the suppression system and the fire is dynamic and complex, and feedback between the two components of the system is expected throughout the test. This follows onto the number of tests required for each scenario considered to be sufficiently high to provide a reasonable confidence level. The specific number of tests required may vary between different potential local residential kitchen fire protection systems, depending on the repeatability of the test results and the desired level of confidence.

It is recommended that at least 3 repeated tests of at least 3 of the most likely (and most challenging for the specific potential local fire protection system) scenarios are tested to establish a measure of the repeatability and the associated confidence in the testing regime. Based on this information, the final number of tests and scenario descriptions that will be used to assess the appropriateness of the system would then be confirmed.

It is recommended to consider the influence of each of the experimental parameters on the test results when selecting the most likely and the most challenging for a specific design for a potential local fire protection system. It is expected that the most influential parameters may vary between different potential suppression systems depending on their specific action and interaction with the fire and the surrounds.

5.2 Influence of Experimental Parameters

Each of the experimental parameters considered in this investigation are discussed in terms of the influence on the test results and the associated difficulties or practicalities.

5.2.1 Electric or Gas Stove-top

Due to the scope of the testing program for this investigation, electrical elements were focused on for the majority of testing. However a few preliminary tests were performed with a gas element for comparison.

The heating regimes for the electric and gas elements is different, as indicated by the examples shown for the thermocouple measurements on the element for the electric element in Figure 4 and the gas element in Figure 140, Figure 144, Figure 148, Figure 152 and Figure 156. The temperature time curve associated with the electrical element is generally smoother than measured for the gas element. This may affect how long it takes for the fuel in the cooking vessel to auto-ignite.

The electric element may also have a different heating regime between sequential tests from wear as well as more apparent changes, such as corrosion of the element

contacts reaching a critical level such that the heating element is adversely affected (e.g. resulting in a slower rate of increase in temperature of the element), or if the element moves to change the contact points or break them all together. Therefore care must be applied to ensure that the electric element is kept in good, clean repair and replaced when damaged during a test.

It is recommended that both an electric stove-top and a gas stove-top be included in the testing to determine the effectiveness of a potential local fire protection system, since the heating regimes are different and the interaction between the stove-top and the suppression system may be different depending on specific designs.

5.2.2 Stove-top Hood and Compartment Air Movement

A stove-top hood was not included in the experimental investigation. However the effect of an extraction fan was included by comparing results for scenarios with and without the furniture calorimeter in operation. The use of the extraction fan for the furniture calorimeter was not intended to simulate the action of a stove-top hood, but instead the action of air movement through the compartment (e.g. if a window or door was open or the kitchen was part of a large open-plan space), where the local air velocities would not be expected to be as high as when a range hood would be present.

The flow in the duct of the furniture calorimeter during these tests was 2.7 - 3.0 m³/s. The local air velocities surrounding the stove-top was not measured, however based on the extraction rate local air speeds of up to 0.1 - 0.5 m/s would be reasonably expected.

An example of this comparison is the results of Section 4.2 and Section 4.3, for free-burning free-standing skillet, containing 200 ml canola oil. Similarly an example for a scenario with suppression for comparison is the results of Section 4.15 and Section 4.17, for a skillet, containing 200 ml canola oil, in the partial corridor with a single sprinkler head.

In the case of the free-burning, free-standing skillet (Section 4.2 and Section 4.3):

- The maximum temperatures measured in the oil were similar (Figure 8a and Figure 14a),
- The maximum temperatures measured 100 mm above the centre of the heating element were generally higher for the tests with the extract in operation (~400 - 800°C, Figure 8b) than for the tests with the extract turned off (~350 - 550°C, Figure 14b),
- The maximum temperatures measured 400 mm above the centre of the heating element were generally lower for the tests with the extract in operation (~100 - 300°C, Figure 8c) than for the tests with the extract turned off (~500 - 900°C, Figure 14c), and
- The maximum temperatures measured at the plate thermometers located at 50 mm and 350 mm above the heating element were similar (Figure 9 and Figure 15).

These results indicate that the air movement associated with the extract influences the flame height and shape when the stove-top was located directly under the extract of the furniture calorimeter. Therefore an operational stove-top hood over a flaming vessel would be expected to influence the flame shape and subsequently is recommended to be included in testing to estimate the effectiveness of a potential local fire protection system.

In the case of the partial corridor with a sprinkler head present (Section 4.15 and Section 4.17):

- The maximum temperatures measured in the oil were generally similar (Figure 97a and Figure 112a), with more variation observed between the tests where the extraction fan was operational (Figure 97a),
- The maximum temperatures measured 100 mm above the centre of the heating element were generally similar for the tests with the extract in operation (Figure 97b) and with the extract turned off (Figure 112b),
- The maximum temperatures measured 400 mm above the centre of the heating element were generally similar, but the tests with the extract in operation showed more variation in the results (~450 - 600°C, Figure 97c) than for the tests with the extract turned off (~600°C, Figure 112c),
- The maximum temperatures measured at the plate thermometers located at 50 mm and 350 mm above the heating element showed good repeatability for the tests with the extract turned off (Figure 113) and more variation between the test results where the extract was in operation (Figure 98),
- Similar to the maximum temperatures at the plate thermometers, the maximum temperatures measured at the locations on the surface of the stove-top (A - E of Figure 1) showed good repeatability for the tests with the extract turned off (Figure 114) and more variation between the test results where the extract was in operation (Figure 99),
- The maximum temperatures measured at the ceiling next to the sprinkler head (1500 mm from the wall behind the stove-top) were higher for the tests where the extract was operational (~90°C, Figure 100a) than the tests where the extract was turned off (~60 - 75°C, Figure 115a),
- The rate of temperature rise measured at the ceiling next to the sprinkler head was consistently slower for the tests where the extract was operational (Figure 100a) compared to the tests where the extract was turned off (Figure 115a), and
- The results for ceiling temperatures closer to the flaming showed increasingly similar maximum values between the sets of tests with extraction on (Figure 100b & c) and off (Figure 115b & c) and less variation between tests with the extraction operational (Figure 100b & c).

The larger variation between results for tests where the extract was in operation is attributed to a slower rate of rise in temperature at the location near the sprinkler head, so that the time from when ignition was observed to when the sprinkler activated was slower and more variable. This delay in the time to system activation allowed the fire to develop further and therefore higher maximum temperatures were recorded in the area surrounding the flaming pan.

These results indicate that there is more variation in the results associated with the furniture calorimeter extraction fan being operational during the partial corridor tests and the temperatures more remote from the flaming rise may rise slower compared to the situation with no extraction present. Based on these results, it is suggested that the air flow through a house compartment containing the kitchen (e.g. if a window were open in the room, etc.) may influence the results of the activation and operation of a potential local fire protection system and, depending on the specific design of the local fire protection system (e.g. where system activation depends on conditions remote from the stove-top and the local area where flaming would be expected), would also be recommended to be included in the testing program for estimating effectiveness.

5.2.3 Cooking Vessel

Three types of cooking vessel were included in the experimental program:

- Skillet (or frying pan)
- Small pan, and
- Stock pot

Results for these three vessels can be compared for 200 ml canola oil, free-standing under the operational furniture calorimeter (e.g. Sections 4.3, 4.9 and 4.10 for a skillet, small pan and stock pot, respectively).

The time flaming was observed was approximately the same for the skillet (~200 s, Figure 14) and stock pot (~250 s, Figure 61). The time flaming was observed in the small pan (~400 s, Figure 54) was approximately twice as long as for either the skillet or stock pot. This is expected because the type and volume of oil was the same in each case, whereas the surface area of the oil is approximately the same in the cases of the skillet and stock pot (i.e. the stock pot is ~80% of the area of the skillet) but the surface area of oil in the small pan is approximately ~30% of the skillet.

Before ignition was observed, the temperature increase in the oil in the stockpot was more rapid than for the skillet or small pan (Figure 14, Figure 54 and Figure 61). This is attributed to the thinner base of the stock pot compared to either the skillet or the small pan. The temperature of the oil in each pan at which ignition was observed was approximately similar (~360 - 380°C) for the three types of cooking vessel considered.

After ignition was observed, the temperatures measured at 400 mm above the centre of the heating element were consistently higher for the stock pot and small pan (both up to 300 - 800°C, Figure 54 and Figure 61) than for the skillet (100- 300°C, Figure 14). This is attributed to the bending of the flames with local drafts that were much more obvious during the skillet tests than during either the small pan or stock pot tests.

The stock pot produced higher maximum heat release rates (60 - 100 kW, Figure 64) than the skillet (50 - 70 kW, Figure 16) or the small pan (30 - 50 kW, Figure 57). This is consistent with the inverse relationship to the length of time for which flaming was observed in each case.

In general the heat associated with the flaming small pan and stock pot was focused more vertically compared to the skillet. Therefore it is recommended that a stove-top of cooking vessels to provide different directional spread of heat is included in any testing regime to estimate effectiveness of a potential local fire protection system.

5.2.4 Fuel

The influence of the type and amount of cooking oil within the vessel was considered.

An example of the different types of oil are shown in the examples of 200 ml canola oil (Section 4.3) and 200 ml peanut oil (Section 4.4) for free-burning, free-standing tests.

Maximum heat release rates were similar for the canola oil (~50 - 75 kW, Figure 16) and the peanut oil (~45 - 85 kW, Figure 23). Although the temperature in the oil was similar at ignition and for the maximum value for both types of oil (Figure 14a and Figure 20a), the maximum temperatures measured at 100 mm above the centre of the heating element were lower for the canola oil (~500 - 800°C, Figure 14b) than for the peanut oil (~650 - 900°C, Figure 20b). In addition, the maximum temperatures measured at 400 mm above the centre of the heating element were also lower for the canola oil (~100 - 350°C, Figure 14c) than for the peanut oil (~200 - 650°C, Figure 20c). The maximum temperatures measured by the plate thermometers located

at 50 mm above the heating element were similar for both oils (~300 - 350°C, Figure 15a and Figure 21a). However the maximum temperatures measured by the plate thermometers located at 350 mm above the heating element were lower for the canola oil (~140 - 180°C, Figure 15b) than for the peanut oil (~140 - 230°C, Figure 21a). There was also more smoke produced with the flaming peanut oil than the canola oil.

An example of the different amounts of oil are shown in the examples of 200 ml canola oil (Section 4.3) and 400 ml canola oil (Section 4.5) for free-burning, free-standing tests.

Maximum heat release rates were lower for the 200ml tests (~50 - 75 kW, Figure 16) than for 400 ml tests (~90 - 110 kW, Figure 30). The maximum temperature in the oil in the pan was lower for the 200 ml tests (~700°C, Figure 14a) than for the 400 ml tests (~750°C, Figure 27a).

Maximum temperatures of the thermocouples located at 100 mm above the centre of the heating element were higher for the 200 ml tests (~450 - 800°C, Figure 14b) than for the 400 ml tests (~200 - 450°C, Figure 27b). The maximum temperatures of the thermocouples located at 400 mm above the centre of the heating element were lower for the 200 ml tests (~100 - 350°C, Figure 14c) than for the 400 ml tests (~750 - 950°C, Figure 27c). This was consistent with a lower flame height associated with the 200 ml tests than the 400 ml tests.

Plate thermometer maximum temperatures were consistently lower for the 200 ml tests (Figure 15) than the 400 ml tests (Figure 28), by approximately 100°C at 50 mm above the heating element and 100 - 150°C at 350 mm above the heating element.

Another example of the different amounts of oil are shown in the examples of 200 ml canola oil (Section 4.15) and 400 ml canola oil (Section 4.16) for single sprinkler heads in a partial corridor test.

Maximum heat release rate values were lower for the 200 ml tests (~50 - 130 kW, Figure 101) than the 400 ml tests (~230 kW, Figure 105). The time from when ignition was observed to the time of sprinkler activation was slightly longer for the 200 ml tests than for the 400 ml tests. However the total time for the heat release rate value to go from approximately 40 kW during the growth phase to approximately 40 kW after the activation of the sprinkler head was similar for both the 200 ml tests and 400 ml tests (approximately 70 - 80 s from 40 kW to 40 kW).

Thermocouple temperatures on the vertical line above the centre of the heating element were similar, with only the thermocouple located at 400 mm above the heating element being lower for the 200 ml tests (~450 - 600°C, Figure 97b) than for the 400 ml tests (~700°C, Figure 106). Plate thermometer temperatures were also similar for the 200 ml (Figure 98) and 400 ml tests (Figure 107). Stove-top surface thermocouple temperatures were similar for the 200 ml test with faster temperature rise at the ceiling (Test 57, Figure 99) and the 400 ml test (Figure 107).

Thermocouples located at the ceiling of the partial corridor were consistently lower for the 200 ml tests (Figure 100) than for the 400 ml tests (Figure 108). The shorter time to activation of the sprinkler during the 400 ml is attributed to these higher ceiling temperatures.

In summary, although there was a relatively small difference between the results for the tests using canola oil and peanut oil (in terms of heat release rate, auto-ignition temperature of the oil in the pan and temperatures of the surrounds during flaming) if the potential local fire suppression depends on visibility, a stove-top of oils with a stove-top of smoke characteristics is recommended for testing the response of the system.

The amount of oil influences the flame height, the maximum temperatures and heat release rates, and duration of flaming. Therefore it is suggested that at least two volumes of a cooking oil are used in the testing of a potential local fire protection system.

5.2.4.1 Fuel Additives

In general, considering the 'fuel' within the cooking vessel, cooking oil by itself is not the only potential scenario expected in a residential kitchen. Food or water from a rinsed pan is also likely to be present in the oil.

It was observed during testing that a small amount of water or foods containing water can cause heated cooking oil to spit oil onto the surfaces surrounding the cooking vessel (e.g. Tests 22, 23, 24, 29, 43 and 58). When spitting of oil occurred before ignition was observed, drops of oil were spread past the diameter of the cooking vessel. These drops of oil on the surfaces surrounding the pan provided fuel for spot fires on the surrounding surfaces after ignition of the oil remaining in the vessel.

Comparing results from tests using cooking oil only (e.g. Sections 4.3 and 4.6) and those with additives to the cooking oil (e.g. Section 4.7 with bacon and Section 4.8 with 20 ml of oil at the beginning of the test), the maximum heat release rate values (~50 - 65 kW) are similar (Figure 16, Figure 38, Figure 42 and Figure 48). The maximum thermocouple measurements 100 mm above the centre of the heating element were also similar for each case (Figure 14b, Figure 34b, Figure 43 and Figure 49). These results indicate that water-based additives do not significantly influence the fire conditions close to the original centre of the oil fire.

Maximum temperatures measured of the thermocouple located 400 mm above the centre of the heating element were lower for the oil only in both the free-standing (~100 - 350°C, Figure 14c) and partial corridor (~400 - 450°C, Figure 34c) orientations than for the test with the bacon as an oil additive (~450 - 650°C, Figure 43) or the 20 ml water as an oil additive (~750 - 900°C, Figure 49). Maximum plate thermometer temperatures were also lower for the oil only scenarios (Figure 15 and Figure 35) than for the bacon or 20 ml water oil-additive tests (Figure 44 and Figure 50) by 50 to 100°C. Temperature spikes were recorded by some of the stove-top surface thermocouples (A - E) during the bacon (Figure 44) and 20 ml water (Figure 50) oil-additive tests. No similar temperature spikes were recorded for the oil only tests (Figure 36). The temperature spikes observed during the tests with water-containing additives to the cooking oil were attributed to the observed spot fires from the oil drops distributed during the heating of the oil before ignition was observed.

It is to be noted that the tests performed for this investigation were in a relatively sterile environment, i.e. with cleared surfaces, without typical residential decoration or clutter (such as surrounding cabinets with melamine or wood panelling, tea towels, plastic containers, etc.) that would be reasonable in a domestic scenario. Thin or flammable items may be susceptible to ignition from spot fires from oil drops that have been ejected during the heating process.

Therefore, instead of cooking oil only being used as the fuel for stove-top fire tests, it is recommended that cooking oil and a small amount of water be used. The amount of 20 ml of water in 200 ml of canola cooking oil was found to cause spitting of the oil during heating and subsequent spot fires after ignition of the oil remaining in the cooking vessel.

5.2.5 De-Energizing the Heating Element

The de-energizing of the heating element after ignition (e.g. Section 4.12), provided a comparison to the free-burning condition where the heating element remained powered until after flameout was observed (e.g. Section 4.3).

Comparing 200 ml canola free-burning in a skillet, while the extraction for the furniture calorimeter is operating, (Section 4.3) with the same scenario where the heating element was de-energized within 4 s of ignition being observed, the maximum heat release rates were slightly higher for the continuously energized element tests (~50 - 75 kW, Figure 16) than for the post-ignition de-energized tests (~40 - 60 kW, Figure 79).

Maximum temperatures in the oil in the pan were similar for the continuously energized element tests (~700°C, Figure 14a) and for the post-ignition de-energized element tests (~750°C, Figure 76a). The post-ignition de-energized element test results show a change in temperature rise at the time of the power being removed from the heating element. The temperature rise continues at a much slower rate directly after the element is de-energized and the rate increases under the sustained burning of the oil.

Maximum temperatures of the thermocouples located at 100 mm above the centre of the heating element were higher for the continuously energized element tests (~450 - 800°C, Figure 14b) than for the post-ignition de-energized element tests (~250 - 400°C, Figure 76b). The maximum temperatures of the thermocouples located at 400 mm above the centre of the heating element were lower for the continuously energized element tests (~100 - 350°C, Figure 14c) than for the post-ignition de-energized element tests (~500 - 900°C, Figure 76c).

Maximum temperatures measured by the plate thermometers located at 50 mm above the heating element were slightly lower for the continuously energized element tests (~300 - 350°C, Figure 15a) compared to the post-ignition de-energized element tests (~400°C, Figure 77a). Maximum temperatures measured by the plate thermometers located at 350 mm above the heating element were similar for the continuously energized element tests (~140 - 180°C, Figure 15b) and the post-ignition de-energized element tests (~150 - 200°C, Figure 77b).

In general, the main influence de-energizing the heating element after flaming has been observed had on the results was to slow the initial growth phase. This slowing of the initial growth phase of the fire influences the results by a slightly reduced maximum HRR and a slightly increased duration period of flaming compared to the continuously energized element tests (i.e. the mass loss rate is slightly decreased).

5.2.6 Manual Fire Suppression

Two modes of manual fire suppression were included in this investigation: application of a fire blanket and application of a dry powder fire extinguisher. These were included to provide comparisons to the free-burning scenarios and the example of an automatic potential local fire protection system (a single residential pendant sprinkler head, e.g. Section 4.16).

5.2.7 Application of Water on an Oil Fire

It was assumed that pouring water into an oil fire was the worst case scenario for an attempted application of a potential suppression component. To establish a comparison with potential local fire suppression that uses water, 200 ml of water was poured into

the pan while the oil was flaming (i.e. within 10 s from when ignition was observed) (e.g. Tests 32 and 33, summarised in Section 4.11).

Comparing 200 ml canola free-burning in a skillet, while the extraction for the furniture calorimeter is operating, (Section 4.3) with the same scenario where 200 ml water is applied within 10 s of ignition being observed, the maximum heat release rates were lower for the free-burning tests (~50 - 75 kW, Figure 16) than for the water applied post-ignition tests (a spike of ~140 kW, Figure 71).

Maximum temperatures in the oil in the pan were higher for the free-burning tests (~700°C, Figure 14a) than for the 200 ml water applied post-ignition tests (~550°C, Figure 68a).

Maximum temperatures of the thermocouples located at 100 mm above the centre of the heating element were higher for the free-burning tests (~450 - 800°C, Figure 14b) than for the 200 ml water applied post-ignition tests (~400°C, Figure 68b). The maximum temperatures of the thermocouples located at 400 mm above the centre of the heating element were lower for the free-burning tests (~100 - 350°C, Figure 14c) than for the 200 ml water applied post-ignition tests (~500°C, Figure 68c). This is consistent with cooling the local area where the water is applied by both removing energy due to the specific heat and heat of evaporation of water as well as moving some flaming oil from the area.

Maximum temperatures measured by the plate thermometers located at 50 mm above the heating element were higher for the free-burning tests (~300 - 350°C, Figure 15a) compared to the 200 ml water applied post-ignition tests (~90 - 130°C, Figure 69a). Maximum temperatures measured by the plate thermometers located at 350 mm above the heating element were higher for the free-burning tests (~140 - 180°C, Figure 15b) than the 200 ml water applied post-ignition tests (~55 - 80°C, Figure 69b). Combined with the information of the spike in the HRR after the application of the 200 ml of water during flaming, the measurements of the plate thermometers (Figure 15) provide an indication that the duration of the intense heat was limited. This situation would be hazardous if easily ignitable materials (e.g. paper, tea towels, etc.) were in the vicinity of the dispersed flaming oil.

Another indication of the dispersion of the flaming oil after the application of the 200 ml of water were the temperature measurements at the stove-top locations (Figure 70). In particular, thermocouples at locations A and C recorded spikes of 450 and 550°C, respectively, followed by a period of up to 200 s of sustained burning at average temperatures of approximately 150 to 200°C. These results confirm the implication of the other thermocouple and plate thermometer results.

5.2.8 Single Sprinkler Head

An example of an automatic potential local fire protection system was a single residential sprinkler head (Section 4.15). This is compared to the equivalent free-burning scenario (e.g. Section 4.6).

Maximum heat release rate values were lower for the free-burning tests (~40 - 50 kW, Figure 38) than for the automatic suppression tests (~50 - 140 kW, Figure 101). However the highest HRR values for the automatic suppression tests (~120 - 140 kW) occur in a short-lived spike directly after the activation of the sprinkler head.

Thermocouple temperatures on the vertical line above the centre of the heating element at heights of 100 mm and 400 mm were similar (~650 - 850°C at 100 mm, Figure 34b and Figure 97b, and ~400 - 600°C at 400 mm, Figure 34c and Figure 97c).

Maximum plate thermometer temperatures were consistently higher for the free-burning tests (~300°C at 50 mm and ~140 - 160°C at 350 mm, Figure 35) than for the automatic suppression tests (~150 - 230°C at 50 mm and ~80 - 130°C at 350 mm, Figure 98). This is consistent with the short duration HRR spikes recorded during the automatic suppression tests.

Maximum stove-top surface thermocouple temperatures were similar for both sets of tests (~160°C at location A and ~180°C at location C for the free-burning tests, Figure 36, and ~180°C at location C and ~150°C at location E for the automatic suppression tests, Figure 99).

Thermocouples located at the ceiling of the partial corridor were consistently lower for the free-burning tests (~120 - 140°C over the centre of the heating element and ~80°C located centrally in the corridor and 770 mm from the wall behind the stove-top, Figure 37) than for the automatic suppression test (~420 - 500°C over the heating element and ~230 - 290°C at 770 mm from the wall, Figure 100). The maximum temperatures recorded at the ceiling thermocouples related to short-duration spikes that occurred directly after activation of the sprinkler head.

6. ESTIMATING FIRE PROTECTION EFFECTIVENESS

For this study the fire protection effectiveness of a system was considered in terms of two aspects: item to item fire spread and flashover.

Considering, in general terms, the desired outcome of an effective local kitchen stove-top fire protection system, effectiveness may be estimated in terms of:

- reduction of amount of energy released in total,
- reduction of amount of energy released per unit of time,
- delay of critical temperatures, heat fluxes or defined conditions being reached, or
- a combination of these.

The amount of any reduction or delay of conditions that a local fire protection system might achieve is in relation to the original challenge scenario without fire protection. The comparison of the measured conditions with and without fire protection provides an indication of the level of protection the fire protection system provides over the completely unprotected scenario.

Potential critical or threshold values are also considered. In terms of item to item fire spread, autoignition temperatures of common materials was considered as well as incident heat flux. Autoignition temperature for wood products (such as fireboard, hardboard or plywood) and polymer products that may be found in a residential home stove-top from approximately 220 to 350°C (based on values summarised by Babrauskas (2003)). An indication of item to item fire spread was chosen as 200°C and 10 kW/m² for surrounding areas at a distance of 0, 0.4 and 1.1 m vertically from the centre of the heating element (based on considerations of where items might be located around or near to the stove, e.g. stove-top hood, cabinets, etc.) and at distances of 0.2 and 0.4 m from the centre of the heating element (based on an estimate of the closest distance an item can be located without being directly on a stove top). An indication of flashover was chosen as 600°C at the ceiling for the partial corridor orientation.

Other factors that may affect the effectiveness of a local fire protection system:

- Spread of flaming oil by splashing when fire protection is activated is a concern.
- Orientation of stove-top and hood within a room is important in the way any fire protection may interact with it and the surroundings.
 - E.g. whether the stove-top is against a wall or part of an island bench may influence the fire behaviour and/or the potential suppression behaviour due to differences in air flow and/or solid obstacles.

There are also many unquantified advantages and disadvantages of different potential residential kitchen stove-top fire protection. For example other considerations not quantified in this investigation may include:

- Are there potential secondary hazards?
 - E.g. short circuiting electrical components, etc.
- How difficult is it to clean the affected area afterwards?
 - E.g. corrosive powders, etc.

These additional factors and currently unquantified advantages and disadvantages are recommended for incorporation with future research in this area.

6.1 Single Sprinkler Head Example

We now consider the example of the potential single automatic sprinkler head (of which test results are summarised in Section 4.15) using the general concepts that effectiveness of a potential local residential kitchen stove-top fire protection system may be estimated in terms of:

- reduction of amount of energy released in total,
- reduction of amount of energy released per unit of time,
- delay of critical temperatures, heat fluxes or defined conditions being reached, or
- a combination of these.

To estimate the performance of the example single sprinkler head system, we firstly compare the test results for the system to the equivalent free-burning test results (Section 4.6). For this example the scenario of an electric stove-top in the partial corridor with the furniture calorimeter extraction operational with a skillet, containing 200 ml canola oil is used to demonstrate this concept. In the full assessment of a potential system, several of these challenging free-burn scenarios would be used in the testing regime, however it is beyond the scope of this project to recommend any specific product or system. Therefore for a specific system to be recommended in the future, a full regime of testing of that specific system must be performed and analysed. A summary of the maximum values for these two types of scenario is presented in Table 2.

The results for the free-burning scenario that is used to challenge the potential fire protection system are averaged. A summary of the averaged results are included in Appendix E.1.

For this investigation a local fire protection effectiveness of 1 is defined as maintaining the conditions 5 s before ignition is observed. This implies that the fire being prevented is the most desired outcome (i.e. effectiveness = 1). In addition, if the fire protection has no effect on the scenario used to challenge it, then the effectiveness would have the value of zero. Furthermore, if the fire protection caused the conditions to worsen (implying that the fire protection is not appropriate for that particular scenario) then the effectiveness would have a negative value. Negative effectiveness values indicate the use of a potential fire protection system in scenarios or conditions beyond its limitations.

6.1.1 Comparing Fire Protected Test Results with the Base Challenge Scenario

The individual test results for both the free-burning challenge scenario and the equivalent scenario with fire protection were aligned in relation to the time at which flaming was initially observed, which correlates well for these tests with the initial temperature rise recorded by the thermocouple located 100 mm above the heating element. In this case ignition is at 626 s (in relation to the summarised test results in Section 4.15). The test results for each variable are normalised with respect to the associated value at time 621s.

The measured values for each experimental variable are normalised with respect to the values at 5 s prior to the time that ignition was observed during the tests. Choosing to normalise with respect to the conditions 5 s prior to ignition, allows for uncontrollable variables (such as ambient temperature, etc.) to be accounted for between tests.

The normalised values are then summed from 5 s prior to ignition (621 s) to flameout (1033 s for the average of Tests 55 and 59, and 753 s for Test 57 and 728 s for Tests 60). It is important to not include values past the time of flameout in the summation of

the normalised values. Only values associated with the flaming are to be included. This process for each experimental variable (e_n) is summarised in Equation 1.

$$E_{n,Test} = \frac{\sum_{t=(t_i-5)}^{t_f} [e_{n,Test}(t)]}{e_{n,Test}(t_i - 5)}$$

Equation 1

Where:

- $e_{n,Test}(t)$ refers to the experimental variable numbered n measured at time step t for each Test number $Test$,
- t refers to time, with the subscript i referring to time of ignition and f referring to time of flameout,
- E_n refers to the cumulative normalised value of the experimental variable $e_n(t)$ over the time from $t = (t_i - 5)$ to $t = t_f$

Cumulative normalised values for each experimental variable are summarised in Table 3.

The improvement, $I_{n,Test}$, (expressed as a fraction) of the results for each test with fire protection ($Test$) compared to the free-burning challenge ($Challenge$) scenario are calculated for each experimental variable (n) by:

$$I_{n,Test} = \frac{(E_{n,Challenge} - E_{n,Test})}{E_{n,Challenge}}$$

Equation 2

The values for improvement in measured experimental conditions for each test with fire protection are summarised in Table 4.

Using this method provides a measure of the average improvement of the results of the tests with fire protection over the results of the challenge scenario. This is a 'lumped' approach, where spikes in measurements or other anomalies are averaged over the time flaming occurs. An improvement value of zero (0) implies that the fire protection does not provide any improvement in measured conditions to the free-burning scenario that the fire protection system is being challenged with. Any negative 'improvement' values (i.e. <0), indicate that the average test results for that particular experimental variable performed worst than in the challenge. This is a way of highlighting potential problems that may be inadvertently caused by the operation of the fire protection system or another problem that would need to be identified and assessed as to the potential for worsening the situation compared to the initial free-burning challenge.

6.1.2 Considering Maximum Measured Values

To address the potential spikes in the recorded experimental variable values, the same concept is applied to the maximum values for each experimental variable (as summarised in Table 2). The improvement, $i_{n,Test,max}$, (also expressed as a fraction) of the maximum value for each experimental variable (e_n) for each test with fire protection present ($Test$) compared to the average of the free-burning challenge tests ($Challenge$) is calculated by:

$$i_{n,Test,max} = \frac{(e_{n,Challenge,max} - e_{n,Test,max})}{e_{n,Challenge,max}}$$

Equation 3

The values for improvement of the maximum values of experimental variables for each test with fire protection are summarised in Table 6. The cells coloured blue contain negative improvement values. On examination of the experiment results for Tests 57 and 60 (Section 4.15), it is obvious that these maximum values are associated with the short-lived spike in temperatures measured directly after activation of the sprinkler head. These are short-lived and the fire protection continues to be applied to the area after the spike in temperatures are recorded and these temperatures are quickly reduced.

6.1.3 Estimating Effectiveness of a Local Fire Protection System

To calculate an estimate of the effectiveness of the tested local fire protection system, the lumped improvement values for each variable and each test are averaged. For this investigation an even weighting of each of the measured experimental variables was used. The estimate of system effectiveness (S) is calculated by:

$$S = \frac{\sum_{Test=1}^{Test_{max}} \sum_{n=1}^{n_{max}} [w_n I_{n,Test}]}{n_{max} Test_{max}}$$

Equation 4

Where:

- S refers to the estimate of the fire protection system effectiveness,
- n_{max} refers to the maximum number of experimental variables,
- $Test_{max}$ refers to the maximum number of tests with the fire protection system being assessed, and
- w_n refers to the weighting of each experimental variable (in this investigation these are set as 1 for all variables considered).

Using this approach and the values presented in Table 4, the value for the single sprinkler head used as a local fire protection system for residential stove-top fires is approximately 0.7 (with a spread from 0.4 to 0.9). However this value is only based on one type of challenge scenario, and therefore this value is only applicable to this particular scenario. To provide a robust estimate of a specific design for a local fire protection system for residential stove-top fires, a more diverse program of testing would be used based on the methodology described in this demonstration of concept.

Table 2: Summary of maximum measured values for the free-burning challenge scenario and the equivalent scenario with fire protection.

Experimental Variable	Maximum Measured Value		
	Free-Burning Challenge Scenario (Average of Tests 55 & 59)	Equivalent Scenario with Fire Protection	
		Tests 57	Test 60
Time from 5 s prior to Ignition to Flameout (s)	413	113	108
Total Energy Released (MJ)	8.2	4.7	3.6
HRR (kW)	50	130	120
Oil TC Temperature (°C)	610	490	430
TC Temperature at 100 mm above Heating Element (°C)	800	830	820
TC Temperature at 400 mm above Heating Element (°C)	440	460	590
TC Temperature at the Ceiling 1150 mm above Heating Element (°C)	130	430	490
PT Temperature at 50 mm above Heating Element (°C)	300	230	150
PT Temperature at 350 mm above Heating Element (°C)	150	130	80
TC Temperature on the Stove-top Surface at A (°C)	110	170	60
TC Temperature on the Stove-top Surface at B (°C)	70	110	40
TC Temperature on the Stove-top Surface at C (°C)	120	180	80
TC Temperature on the Stove-top Surface at D (°C)	70	130	50
TC Temperature on the Stove-top Surface at E (°C)	70	150	60
Ceiling TC Temperature at the Ceiling at 770 mm from Wall (°C)	80	230	290
Ceiling TC Temperature at the Ceiling at 1500 mm from Wall (at sprinkler head) (°C)	60	90	90

Note:

TC refers to thermocouple

PT refers to plate thermocouple

Table 3: Summary of summations of normalised values for the free-burning challenge scenario and the equivalent scenario with fire protection from 5 s prior to ignition to flameout.

Experimental Variable	Summation of Normalised Values		
	Free-Burning Challenge Scenario (Average of Tests 55 & 59)	Equivalent Scenario with Fire Protection	
		Test 57	Test 60
Time from 5 s prior to Ignition to Flameout (s)	413 s	113 s	108 s
Total Energy Released (MJ)	8.2 MJ	4.7 MJ	3.6 MJ
Oil TC Temperature	560	150	110
TC Temperature at 100 mm above Heating Element	2140	950	590
TC Temperature at 400 mm above Heating Element	1940	920	610
TC Temperature at the Ceiling 1150 mm above Heating Element	1100	600	560
PT Temperature at 50 mm above Heating Element	1810	340	220
PT Temperature at 350 mm above Heating Element	1598	280	180
TC Temperature on the Stove-top Surface at A	1000	330	180
TC Temperature on the Stove-top Surface at B	840	260	150
TC Temperature on the Stove-top Surface at C	1180	380	210
TC Temperature on the Stove-top Surface at D	1000	330	170
TC Temperature on the Stove-top Surface at E	990	330	180
Ceiling TC Temperature at the Ceiling at 770 mm from Wall	930	370	340
Ceiling TC Temperature at the Ceiling at 1500 mm from Wall (at sprinkler head)	840	270	180

Note:

TC refers to thermocouple

PT refers to plate thermocouple

Table 4: Summary of improvement in measured experimental conditions for the scenario with fire protection compared to the free-burning challenge scenario based on summations of normalised values.

Experimental Variable	Improvement of the Equivalent Scenario with Fire Protection Compared to the Challenge Scenario	
	Test 57	Test 60
Time from 5 s prior to Ignition to Flameout (s)	0.7	0.7
Total Energy Released (MJ)	0.4	0.6
Oil TC Temperature	0.7	0.8
TC Temperature at 100 mm above Heating Element	0.6	0.7
TC Temperature at 400 mm above Heating Element	0.5	0.7
TC Temperature at the Ceiling 1150 mm above Heating Element	0.5	0.5
PT Temperature at 50 mm above Heating Element	0.8	0.9
PT Temperature at 350 mm above Heating Element	0.8	0.9
TC Temperature on the Stove-top Surface at A	0.7	0.8
TC Temperature on the Stove-top Surface at B	0.7	0.8
TC Temperature on the Stove-top Surface at C	0.7	0.8
TC Temperature on the Stove-top Surface at D	0.7	0.8
TC Temperature on the Stove-top Surface at E	0.7	0.8
Ceiling TC Temperature at the Ceiling at 770 mm from Wall	0.6	0.6
Ceiling TC Temperature at the Ceiling at 1500 mm from Wall (at sprinkler head)	0.7	0.8

Note:

TC refers to thermocouple

PT refers to plate thermocouple

Table 5: Summary of improvement in maximum values of measured experimental conditions for the scenario with fire protection compared to the free-burning challenge scenario based on the values summarised in Table 2.

Experimental Variable	Improvement of the Equivalent Scenario of Maximum Experimental Variable Values with Fire Protection Compared to the Challenge Scenario	
	Test 57	Test 60
HRR	-1.8	-1.6
Oil TC Temperature	0.2	0.3
TC Temperature at 100 mm above Heating Element	0.0	0.0
TC Temperature at 400 mm above Heating Element	0.0	-0.3
TC Temperature at the Ceiling 1150 mm above Heating Element	-2.3	-2.7
PT Temperature at 50 mm above Heating Element	0.2	0.5
PT Temperature at 350 mm above Heating Element	0.2	0.5
TC Temperature on the Stove-top Surface at A	-0.5	0.4
TC Temperature on the Stove-top Surface at B	-0.6	0.4
TC Temperature on the Stove-top Surface at C	-0.5	0.4
TC Temperature on the Stove-top Surface at D	-0.9	0.2
TC Temperature on the Stove-top Surface at E	-1.0	0.2
Ceiling TC Temperature at the Ceiling at 770 mm from Wall	-2.0	-2.6
Ceiling TC Temperature at the Ceiling at 1500 mm from Wall (at sprinkler head)	-0.4	-0.4

Note:

TC refers to thermocouple

PT refers to plate thermocouple

7. SUMMARY & CONCLUSIONS

A summary of the highlights and conclusions from this investigation includes:

- A test apparatus and methodology was developed to estimate the effectiveness of potential local fire protection systems for residential stove-top fires.
 - Two orientations for the test apparatus were investigated: free-standing and within a partial corridor (to represent a larger room).
 - Results from both orientations were used to form a fundamental understanding of the complexities of defining a 'stove-top fire' and the influencing experimental parameters.
 - Challenge scenarios are free-burning fire scenarios with no fire protection present. These test results form a baseline to compare to the equivalent scenarios with the proposed local fire protection system present.
 - An estimate of the effectiveness of a potential local fire protection system is calculated from the test results of the challenge scenarios and the equivalent scenarios with the fire protection system present.
 - An example system, consisting of a single residential sprinkler head, was used to demonstrate the proposed concept.
- Repeatability of the free-burning experiments was good. This provided confidence in a consistent level of challenge being available for assessing potential fire protection systems.
- Repeatability associated with the experiments with potential fire protection systems present was lower than for the baseline challenge scenarios.
 - This lower repeatability is expected, since the interaction of the suppression system and the fire is dynamic, complex and feedback is expected throughout the test.
 - The number of tests required for each challenge scenario must be sufficient to provide a reasonable confidence level. Specific numbers of tests required will vary between different potential local residential kitchen fire protection systems, depending on the repeatability of the test results and the desired level of confidence.
- Electrical elements were the primary focus for the majority of testing due to the necessity to limit the scope of the investigation. However a few preliminary tests were performed with a gas element for comparison.
 - Care must be applied to ensure that the electric element is kept in good, clean repair and replaced when damaged during a test to ensure consistent heating regimes between sequential tests.
 - The heating regimes for the electric and gas elements was found to be different.
 - It is recommended that both an electric stove-top and a gas stove-top be included in the testing to determine the effectiveness of a potential local fire protection systems, since the heating regimes are different and the interaction between the stove-top and the suppression system may be different depending on specific designs.

- The effect of an extraction fan was included in free-standing orientation tests by comparing results for scenarios with and without the furniture calorimeter in operation.
 - Analysis of free-standing test results indicated that the air movement associated with the operational extract influences the flame height and shape when the stove-top was located directly under the extract of the furniture calorimeter. Therefore an operational stove-top hood over a flaming vessel would also be expected to influence the flame shape.
 - A stove-top hood would provide different local air movement that may affect the operation and effectiveness of a potential local fire protection system, as well as potentially providing additional fuel for the initial fire. Therefore it is recommended that an operational stove-top hood be included in the experimental parameters for challenging a potential system.
- The effect of an extraction fan was also included in partial corridor orientation tests by comparing results for scenarios with and without the furniture calorimeter in operation, where the entire partial room was located under the extraction hood.
 - Analysis of partial corridor test results indicated that there is more variation in the results associated with the furniture calorimeter extraction fan being operational. Temperatures more remote from the flaming rise may rise more slowly than when compared to the situation with no extraction present.
 - Based on these results, it is suggested that the air flow through a house compartment containing the kitchen (e.g. if a window were open in the room, etc.) may influence the results of the activation and operation of a potential local fire protection system and, depending on the specific design of the local fire protection system (e.g. where system activation depends on conditions remote from the stove-top and the local area where flaming would be expected), would also be recommended to be included in the testing program for estimating system effectiveness.
- Three types of cooking vessel were included in the experimental program: a skillet, small pan, and stock pot.
 - It was found that the heat associated with the flaming small pan and stock pot was focused more vertically compared to the skillet.
 - It is recommended that a stove-top of cooking vessels to provide different directional spread of heat is included in any testing regime to estimate effectiveness of a potential local fire protection system.
- The influence of the type (canola and peanut) and volume (200 ml and 400 ml) of cooking oil within the vessel was considered.
 - A relatively small difference was found between the results for the tests using canola oil and peanut oil (in terms of heat release rate, auto-ignition temperature of the oil in the pan and temperatures of the surrounds during flaming), however if the potential local fire suppression depends on visibility, a stove-top of oils with a stove-top of smoke characteristics is recommended for testing the response of the system.
 - The amount of oil was found to influence the flame height, maximum temperatures and heat release rates, and duration of flaming. Therefore

it is suggested that at least two volumes of a cooking oil are used in the testing of a potential local fire protection system.

- The ‘fuel’ within the cooking vessel is not realistically expected to be solely cooking oil. Therefore various foods and small amounts of water (e.g. from a rinsed pan) were present in the oil for some tests.
 - Small amounts of water or foods containing water were found to spit oil drops before ignition was observed. After ignition was observed in the pan, these oil drops on the surfaces surrounding the pan created spot fires.
 - It is recommended that cooking oil and a small amount of water be included in the challenge scenarios for assessing a potential local fire protection system.
- The tests performed for this investigation were in a relatively sterile environment, i.e. with cleared surfaces, without typical residential decoration or clutter (such as surrounding cabinets with melamine or wood panelling, tea towels, plastic containers, etc.) that would be reasonable in a domestic scenario. Thin or flammable items may be susceptible to ignition from spot fires from oil drops that have been ejected during the heating process.
- De-energizing the heating element shortly after flaming was observed, was found to slow the initial growth phase. This slowing of the initial growth phase of the fire influences the results by a slightly reduced maximum HRR and a slightly increased duration period of flaming compared to the continuously energized element tests.
- It was assumed that pouring water into an oil fire was the worst case scenario for an attempted application of a potential suppression component. To establish a comparison with potential local fire suppression that uses water, 200 ml of water was poured into the pan while the oil was flaming.
 - Analysis of test results showed that the combination of apparatus, instrumentation and methodology was capable of indicating that the application of 200 ml of water had a cooling effect on the local area where the water was applied and that areas outside of the pan had local flaming.
- It was suggested that the desired outcome of an effective local kitchen stove-top fire protection system, effectiveness may be estimated in terms of:
 - reduction of amount of energy released in total,
 - reduction of amount of energy released per unit of time,
 - delay of critical temperatures, heat fluxes or defined conditions being reached, or
 - a combination of these.
- The estimate of the effectiveness of a local fire protection system is based on the comparison of test results for challenge scenarios (free-burning tests with no fire protection present) and the test results for the equivalent scenarios with the system present.
- A local fire protection effectiveness of 1 was defined as maintaining the pre-ignition conditions (5 s before ignition is observed).

- This implies that the fire being prevented is the most desired outcome (i.e. effectiveness = 1).
- If the fire protection has no effect on the scenario used to challenge it, then the effectiveness would have the value of zero.
- If the fire protection caused the conditions to worsen (implying that the fire protection is not appropriate for that particular scenario) then the effectiveness would have a negative value. Negative effectiveness values indicate the use of a potential fire protection system in scenarios or conditions beyond its limitations.
- The value for the example single sprinkler head used as a local fire protection system for residential stove-top fires is approximately 0.7 (with a spread from 0.4 to 0.9).
 - This value is only based on one type challenge scenario, and therefore this value is only applicable to this particular type of scenario.
 - To provide a robust estimate of a specific design for a local fire protection system for residential stove-top fires, a more diverse program of testing would be used based on the methodology described in this demonstration of concept.

7.1 Recommended Test Methodology

There are infinite permutations for residential kitchen configurations. Therefore it is important to identify both the configurations that are expected to be successfully protected by a specific fire protection system as well as those that would be expected to cause problems with the effectiveness of the system. Therefore the key points that must be initially described are for each specific system to be tested are:

- Identify the specific design of the proposed fire protection system, including any parts that are intended to be interchangeable or optional,
- Identify the suppression system in terms of what it is designed to achieve and in what conditions/situations, and
- Identify limiting factors for the system in terms of kitchen configurations. (This list may be subsequently modified or added to based on analysis of test results.)

The answers to these key points will define the scope of the testing program that is necessary to challenge the system and provide an estimate of the effectiveness of the system for the tested scenarios. Then the methodology described in Sections 3 and 6 would provide a robust estimate of the effectiveness of a specific local fire protection system for residential stove-top fires and the limitations of scenarios and conditions of the system.

It is recommended that initially at least 3 repeated tests of at least 3 of the most likely (and most challenging for the specific potential local fire protection system) scenarios are tested to establish a measure of the repeatability and the associated confidence in the testing regime. Based on this information, the final number of tests and scenario descriptions that will be used to assess the appropriateness of the system would then be confirmed.

7.2 Recommendations for Future Research

Recommended areas for consideration in future research involving residential kitchen fires, local fire protection methods or estimation of fire protection effectiveness include:

- Consideration of ignition/fire prevention systems (such as temperature limiting switches for the stove-top, etc.) either instead of or in conjunction with fire protection systems.
- Expand the testing to include the effect of stove-top hoods, and gas stove-tops.

8. REFERENCES

- Aherns, M, Hall, JR, Comoletti, J, Gamache, S and LeBeau, A. 2007. *Behavioral Mitigation of Cooking Fires Through Strategies Based on Statistical Analysis, FA-312*. United States Fire Administration, National Fire Data Center, Emmetsburg, MD.
- Babrauskas, V. 2003. *Ignition Handbook*. Fire Science Publishers, Issaquah, WA, USA.
- CPSC 1998. Study of Technology for detecting Pre-Ignition Conditions of Cooking Related Fires Associated with Electric and Gas Stove-tops: Phase III. United States Consumer Product Safety Commission, Washington, DC.
- Energy International 2000. *Development of a Control System for Preventing Food Ignition on Gas Stove-tops, Energy International, Inc. Report No. 00-9615-AR9615001*. Energy International, Inc., Washington, DC.
- Dillon SE. 1998. *Analysis of the ISO 9705 Room/Corner Test: Simulations, Correlations and Heat Flux Measurements, NIST GCR 98-756*. National Institute of Standards and Technology, Gaithersburg, MD, USA.
- EN 1363 *Fire Resistance Tests, Part 1: General Requirements*. 1999. British Standards Institute, London, UK.
- FEMA 2004. *Kitchen Fires, Topical Fire Research Series, Volume 4, Issue 4*. Federal Emergency Management Agency, United States Fire Administration, National Fire Data Center, Emmetsburg, MD.
- Hall, JR. 1997. *US Home Cooking Fire Patterns and Trends Through 1995*. National Fire Protection Association, Quincy, MS.
- Hall, JR. 2006. *Home Cooking Fire Patterns and Trends*. National Fire Protection Association, Quincy, MA.
- Holman JP. 1990. *Heat Transfer*. 7th Edition. McGraw-Hill International, London.
- Inconel® Alloy 600*. 2008. Special Metals Corporation. Accessed on 6 January 2009. [http://www.specialmetals.com/documents/Inconel%20alloy%20600%20\(Sept%202008\).pdf](http://www.specialmetals.com/documents/Inconel%20alloy%20600%20(Sept%202008).pdf)
- Ingason H and Wickstrom U. 2007. *Measuring Incident Radiant Heat Flux Using the Plate Thermometer*. Fire Safety Journal 42: 161-166.
- ISO 834 *Fire-Resistance Tests - Elements of Building Construction - Part 1: General Requirements*. 1999. International Organisation for Standardization, Geneva, Switzerland.
- Johnsson, EL. 1995. *Study of Technology for Detecting Pre-Ignition Conditions of Cooking-Related Fires Associated with Electric and Gas Stove-tops and Cooktops, Phase I Report, NISTIR 5729*. National Institute of Standards and Technology, Gaithersburg, MD.
- Johnsson, EL. 1998. *Study of Technology for Detecting Pre-Ignition Conditions of Cooking-Related Fires Associated with Electric and Gas Stove-tops and Cooktops, Final Report, NISTIR 5950*. National Institute of Standards and Technology, Gaithersburg, MD.
- King, TK. 1998. *Stove-top Hood Fire Extinguishing Systems in US Marine Corps Family Housing*. Headquarters, US Marine Corps, National Fire Academy, Washington, DC.
- Madrzykowski, D. 1998. *Water Additives for Increased Efficiency of Fire Protection and Suppression*. Fire Detection, Fire Extinguishment and Fire Safety Engineering. Fire Fighting Future 50th Session Tokyo, Japan.

- Madrzykowski, D. 2009. Personal Communication concerning *Local kitchen fire suppression testing*. National Institute of Standards and Technology, Gaithersburg, MD.
- Madrzykowski, D, Hamins, A and Mehta, S. 2007. *Residential Kitchen Fire Suppression Research Needs: Workshop Proceedings*. U.S. Department of Commerce, National Institute of Standards and Technology, Washington DC, MD.
- Nicholson, J. 2006. *Watch What You Heat*. NFPA Journal 100(5).
- Robbins, AP and Collier, PCR. 2009. *Heat Flux Measurements: Experiments and Modelling. BRANZ Study Report 206*. BRANZ Ltd, Judgeford, New Zealand.
- Robbins, AP, Wade, CA, Bengtsson, MJ, Howard, N and Soja, E. 2008. *Revision of Cost Effectiveness Analysis of Home Sprinkler Systems incorporating Sustainability Aspects*. New Zealand Fire Service Commission: Wellington, New Zealand.
- Robbins, AP. 2010. *Residential Kitchen Local Fire Protection - Cost Effectiveness Analysis*. BRANZ Study Report 226. BRANZ Ltd, Judgeford, New Zealand.
- Subject 300A Outline of Investigation for Extinguishing System Units for Residential Stove-top Top Cooking Surfaces*. 2006. Underwriters Laboratories Inc.
- UL 2009. *UL Online Certifications Directory, Residential Stove-top Top Extinguisher Units*. Underwriters' Laboratory Inc. Accessed on 30 June 2009. http://database.ul.com/cgi-bin/XYV/cgifind.new/LISEXT/1FRAME/srchres.html?collection=/data3/verity_collections/lisext&vdkhome=/data3/verity_sw_rev24/common&SORT_BY=textlines:asc,cnshorttitle:asc&query=GMCH%3CIN%3ECCN+and+not+GUIDEINFO.
- United States Fire Administration (USFA). 2003. *National Residential Fire Sprinkler Initiative*. Summary of Meeting, April 9-10, 2003.
- USCPSC 1998. *Study of Technology for detecting Pre-Ignition Conditions of Cooking Related Fires Associated with Electric and Gas Stove-tops: Phase III*. United States Consumer Product Safety Commission, Washington, DC.

APPENDIX A METHOD OF ANALYSIS OF PLATE THERMOMETER DATA

A.1 General Description of Plate Thermometer Construction

The plate thermometers were constructed in accordance with ISO 834-1 (1999) and EN1363-1 (1999).

The plate thermometers are made from a 0.7 ± 0.1 mm thick nickel alloy (INCONEL[®] 600) sheet. The 150 x 100 mm sheet is folded to form a plate thermometer with a face of 100 x 100 mm, as shown in Figure 119.

A K-type thermocouple was secured to the centre of the back face of the nickel alloy sheet by a small (25 x 6 mm) steel strip and two 2 mm diameter screws. A (97 x 97 mm x 10 mm thick) pad of inorganic insulation material (Kaowool[™] VF board) was fitted behind the thermocouple.

The completed plate thermometer was conditioned by exposure in a fire resistance furnace for the first 90 min of the standard time/temperature curve.

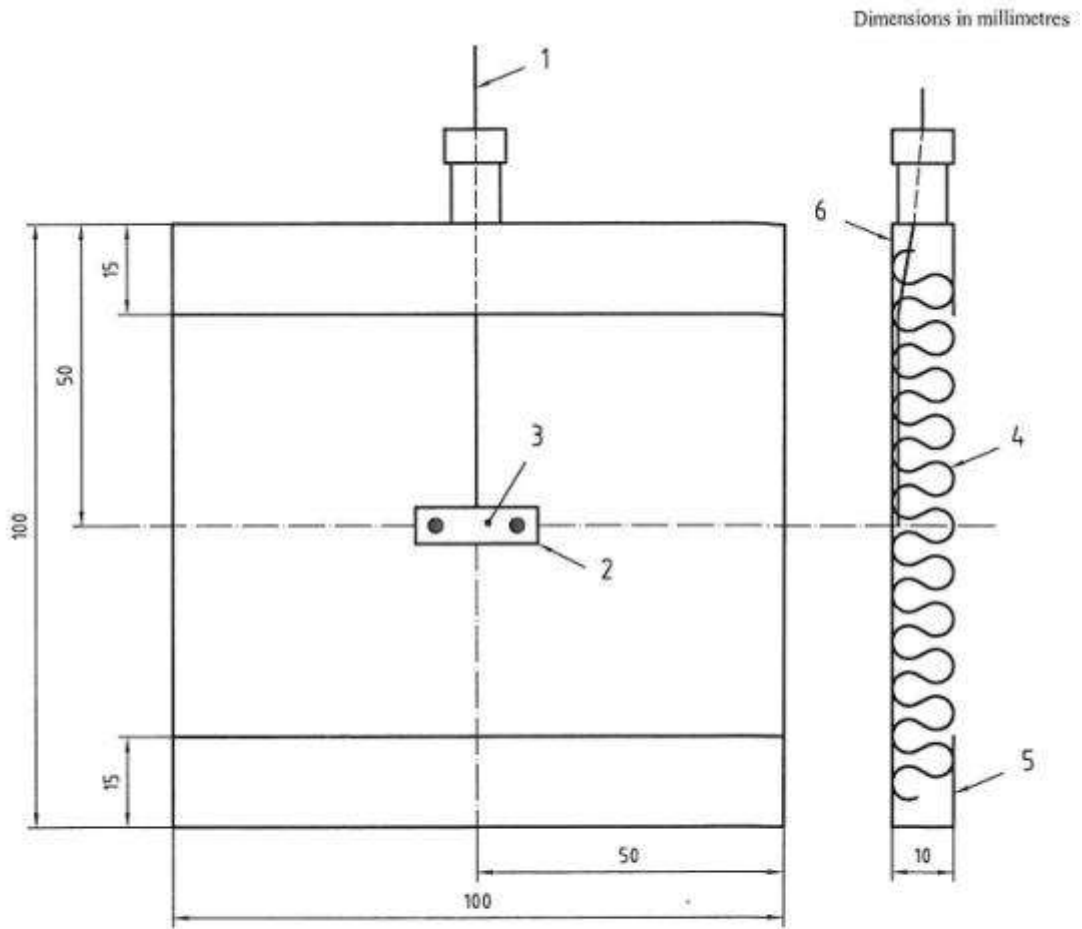

- Key**
- 1 Sheathed thermocouple with insulated hot junction
 - 2 Spot-welded or screwed steel strip
 - 3 Hot junction of thermocouple
 - 4 Insulation material
 - 5 Nickel alloy strip ($0,7 \pm 0,1$) mm thick
 - 6 Face A

Figure 119: Schematic of the back and side of a plate thermocouple. Extracted from (ISO 834-1 1999) and (EN 1363-1 1999).

A.2 Theory – Estimation of the incident radiation for a plate thermometer – Previous Approach

An approach for estimating the incident radiation that a plate thermometer is subject to, as suggested by Ingason and Wickstrom (2007) and also used in another BRANZ study report (Robbins & Collier 2009), is to assume the INCONEL® 600 plate to be infinitely long and wide (i.e. an infinite plate) in air on one side and adjacent to mineral insulation on the other. A schematic of the assumed heat transfer associated with a plate thermometer is shown in Figure 121. Where:

- T_p refers to the temperature measured at the surface of the plate thermometer adjacent to the mineral insulation (K)
- T_s refers to the temperature at the surface of the plate thermometer adjacent to air (K)
- δ_{plate} refers to thickness of the plate thermometer (m)

- $\dot{q}_{rad,net}'' = \dot{q}_{rad,inc}'' - \dot{q}_{rad,reflect}'' - \dot{q}_{rad,emit}''$ refers to the net radiation flux received at the surface of the plate (W/m²)
- $\dot{q}_{rad,inc}''$ refers to the incident radiation flux received at the surface of the plate thermometer (W/m²)
- $\dot{q}_{rad,reflect}''$ refers to the incident radiation flux reflected at the surface of the plate thermometer (W/m²)
- $\dot{q}_{rad,emit}''$ refers to the emitted radiation flux from the surface of the plate thermometer to the surrounds (W/m²)
- \dot{q}_{conv}'' refers to the convective heat flux from the hot surrounding gases to the surface of the plate (W/m²)
- \dot{q}_{store}'' refers to the energy stored in the material of the plate per unit area of the surface of the plate thermometer (W/m²)
- \dot{q}_{cond}'' refers to the conductive heat flux through the metal plate thickness (W/m²)
- $\dot{q}_{cond,1}''$ refers to the conductive heat flux losses attributed to the geometry (length and width) of the plate (W/m²), and
- $\dot{q}_{cond,2}''$ refers to the conductive heat flux losses to the mineral insulation (W/m²).

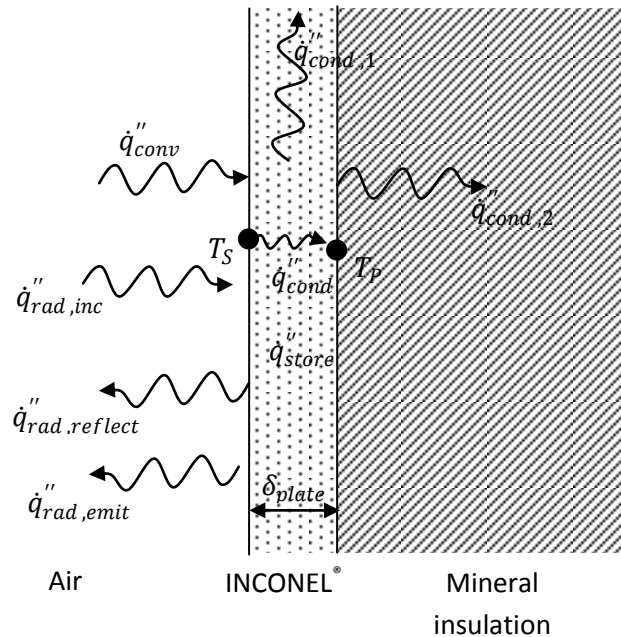

Figure 120: Schematic of heat transfer concerning a plate thermometer. Not to scale.

Balancing the energy for the situation shown in Figure 121 provides:

$$\dot{q}_{tot}'' = \dot{q}_{rad,net}'' + \dot{q}_{conv}'' = \dot{q}_{cond}'' + \dot{q}_{store}'' + \dot{q}_{cond,1}'' + \dot{q}_{cond,2}''$$

Equation 5

Which can be rewritten as:

$$\dot{q}_{rad,inc}'' - \dot{q}_{rad,reflect}'' - \dot{q}_{rad,emit}'' = \dot{q}_{cond}'' + \dot{q}_{store}'' + \dot{q}_{cond,losses}'' - \dot{q}_{conv}''$$

Equation 6

Where $\dot{q}_{cond,losses}''$ refers to an estimate of the combined thermal losses attributed to the plate geometry and the non-adiabatic properties of the mineral insulation.

$$\dot{q}_{rad,inc}'' - (1 - \varepsilon_{plate})\dot{q}_{rad,inc}'' - \sigma T_S^4 = \dot{q}_{cond}'' + \dot{q}_{store}'' + \dot{q}_{cond,losses}'' - \dot{q}_{conv}''$$

Equation 7

$$\dot{q}_{rad,inc}'' = \frac{1}{\varepsilon_{plate}} (\dot{q}_{cond}'' + \dot{q}_{store}'' + \dot{q}_{cond,losses}'' - \dot{q}_{conv}'') + \sigma T_S^4$$

Equation 8

Where:

- ε_{plate} refers to the emissivity of the plate thermometer (dimensionless), and
- σ refers to the Stefan-Boltzmann constant ($W/m^2 K^4$).

This is in agreement with the theory presented by (Ingason and Wickstrom 2007).

If it is assumed that the temperatures associated with the convection between the plate and the surrounding gas and the conduction losses associated are ambient (T_∞), then Equation 8 can be rewritten as:

$$\dot{q}_{rad,inc}'' = \frac{1}{\varepsilon_{plate}} \left(k_{plate}(T_S - T_P) + \rho_{plate} C_{P,plate} \delta_{plate} \frac{\Delta \left(\frac{T_P + T_S}{2} \right)}{\Delta t} + K_{cond}(T_P - T_\infty) - H_{conv}(T_S - T_\infty) \right) + \sigma T_S^4$$

Equation 9

Where:

- k_{plate} refers to the thermal conductivity of the metal plate ($W/m^2 K$)
- ρ_{plate} refers to the density of the metal plate (kg/m^3)
- $C_{P,plate}$ refers to the specific heat of the metal plate ($J/kg K$)
- t refers to time (s)
- K_{cond} represents an estimate for the combined conduction heat transfer coefficients and path length for the conductive heat losses attributed to the geometry of the plate and the non-adiabatic conditions of the mineral insulation ($W/m^2 K$), and
- H_{conv} represents the estimated convective heat transfer coefficient of the plate associated with heat transfer from the surrounding hot gases to the plate thermometer ($W/m^2 K$).

Where the heat transfer coefficient K_{cond} is estimated based on experimental results for the calibration of the plate thermometers, and H_{conv} is estimated based on theory for a horizontal plate exposed to natural convection (using the approach described by Ingason and Wickstrom (2007), where:

$$H_{conv} = 4.0 \left(\frac{(T_S - T_\infty)}{L_{plate}} \right)^{1/4} (T_S + T_\infty)^{-0.16}$$

Equation

10

Where L_{plate} refers to the characteristic length of the plate thermometer.

Furthermore assuming that the surface temperature of the plate is the same as the temperature between the plate and the insulation ($T_S = T_P$), then Equation 9 was rewritten by Ingason and Wickstrom (2007) as:

$$\dot{q}_{rad,inc}'' = \frac{1}{\varepsilon_{plate}} \left(\rho_{plate} C_{p,plate} \delta_{plate} \frac{\Delta T_{PT}}{\Delta t} + K_{cond}(T_{PT} - T_\infty) - H_{conv}(T_{PT} - T_\infty) \right) + \sigma T_{PT}^4$$

Equation

11

In summary, the error associated with this approach is dependent on the assumptions:

- The plate thermometer, from the perspective of the measurement thermocouple, can be described by an infinite plate,
- The surface temperature is the same as the temperature between the metal plate and the backing insulation ($T_S = T_P$) (i.e. a lumped parameter system is sufficient to describe this system),
- The convection heat transfer coefficient (H_{conv}) can be estimated by a horizontal plate under natural convection conditions (Equation 10) (although the experiments performed here use the plate thermometers in a vertical orientation and some mixing) resulting in localised turbulent flow, which is expected in the ISO room experiments compared to a theoretically isolated plate,
- The local gas temperature is assumed to be ambient ($T_{local\ gas} = T_\infty$),
- The temperature of the backing insulation is assumed to be ambient ($T_{insulation} = T_\infty$),
- The loss of heat to the insulation and the non-one-dimensional heat transfer through the metal Plate Can be estimated by an effective lumped conduction heat transfer coefficient (K_{cond}). This lumped coefficient is assumed to be temperature independent and is estimated using experimental data from a calibration phase.

Each of these assumptions were considered in turn in terms of the experimental results (Robbins & Collier 2009). This discussion is summarised here.

A.2.1 Impact of assumption - Uniform plate thermometer temperature

Using the previous analysis approach, it is assumed that the surface temperature is the same as the temperature between the metal plate and the backing insulation ($T_S = T_P$).

The experimental results of the study showed that in general the assumption that thermocouples located on the front and back surfaces of the metal plate measure similar temperatures. However it is noted that the front and back thermocouple temperatures show the most difference when initially exposed to the heat source and

then initially when removed from the heat source. Therefore when a variable heat source is of interest this assumption may not be appropriate. (Robbins & Collier 2009)

A.2.2 Impact of assumption - Convective heat transfer coefficient

The convection heat transfer coefficient (H_{conv}) was estimated for a horizontal plate under natural convection conditions (Equation 6). This assumption is expected to be valid for the cone calorimeter tests, where the plate thermometers were oriented in a horizontal position with natural convection conditions. However the experiments performed in the furniture calorimeter or the ISO room used the plate thermometers in a vertical orientation. Mixing of hot and cooler gases, resulting in localised turbulent flow, is expected in the ISO room experiments compared to a plate located in a large open space. (Robbins & Collier 2009)

Dillon (1998) proposed a convective heat transfer coefficient for vertically orientated plate thermometers that was suggested as 8.6 W/m²K for natural convection within a one-fifth-scale ISO room. Values of 13.8 and 15.9 W/m²K were suggested for regions within the flame, where forced convection was assumed, for 100 and 300 kW HRRs respectively (Dillon 1998).

A.2.3 Impact of assumption - Conduction correction factor

The loss of heat to the insulation and the non-one-dimensional heat transfer through the metal plate was estimated by an effective lumped conduction heat transfer coefficient (K_{cond}). This lumped coefficient was assumed to be temperature independent and was estimated as approximately 4 W/m²K using experimental data from the calibration phase using cone calorimeter test results. (Robbins & Collier 2009)

However the results from the calibration using cone calorimeter test showed that the value for this effective conduction coefficient varied over the target incident fluxes tested, with lower values generally associated with lower target incident fluxes compared to higher target incident fluxes. (Robbins & Collier 2009)

The effective conduction coefficient value of 4 W/m²K is consistent with the value of 5 W/m²K previously suggested to provide sufficiently accurate results compared to water-cooled Gardon gauge results (Ingason and Wickstrom 2007). Whereas a higher value for the effective conduction coefficient of ~22 W/m²K was estimated for the use of plate thermometers in vertical orientation with fire plume impingement (Ingason and Wickstrom 2007).

Since the plate thermometers in these set of experiments were not in the plume except for short durations during some furniture calorimeter tests where the burner flame was observed to lean in a direction of an equipment tree, a value as high as 22 W/m²K would not be expected. However the local turbulent conditions observed during the ISO room experiments where plate thermometers were either submerged in the hot layer or near the layer interface is expected to provide conditions related to an increase in the effective thermal conductivity coefficient value estimated in natural convection conditions. (Robbins & Collier 2009)

Comparison of estimates of incident radiative heat flux from plate thermometer measurement and Gardon gauge results from the furniture calorimeter tests provided more insight into this (Robbins & Collier 2009).

A.2.4 Impact of assumption - Local gas and backing insulation temperature

The local gas temperature was assumed to be ambient ($T_{local\ gas} = T_{\infty}$) as was the temperature of the backing insulation ($T_{insulation} = T_{\infty}$). These assumptions affect the heat transfer losses by convection and conduction (Equation 11).

These are likely to be reasonable assumptions for the cases of the cone calorimeter tests and furniture tests, where a hot layer is not maintained and the total test duration is not long enough for the backing insulation to heat up. However when the plate thermometer is submerged in the hot layer during a compartment test, then the assumption of the local gas being ambient temperature is no longer valid. In addition, test durations may be long enough for the backing insulation to heat up. (Robbins & Collier 2009)

For the furniture calorimeter and ISO room tests, temperatures of the surface of sample materials adjacent to each plate thermometer were recorded. Thermocouples were also used across the ceiling and in a tree near the door of the ISO room. These measurements could be used to estimate a local gas measurement in future analyses. The impact of the assumption of ambient local gas temperatures could then be assessed at this time in comparison with results using an estimate of the local gas temperature. (Robbins & Collier 2009)

A.2.5 Impact of assumption - Lumped parameter model approach

The average response time for a plate thermometer to reach a quasi steady state estimate of the incident radiative heat flux when subjected to a steady state incident heat flux of 250 to 350 s indicates that the assumptions used to develop the theory may not be as appropriate as possible. The appropriateness of the assumptions presented in Section 3.2.1 is related to the scenario. That is, if the incident heat flux is known to be quasi steady state or changes with time relatively slowly, then these assumptions are appropriate for estimating the incident radiative heat flux from the temperatures measured at the plate thermometers. However if the plate thermometers are required to provide an estimate of the incident radiative heat flux for scenarios where the heat source is variable, then another approach may be more appropriate. (Robbins & Collier 2009)

The analysis assumption that the plate thermometer is a lumped parameter system contributes to the rise time of the plate thermometer to incident radiation changes. Taking more transitive aspects into account in the theory used for analysis may reduce the rise time.

A.2.6 Suggestions for alternative theories or estimate approaches

Robbins and Collier (2009) also suggested that from the results of their experiments and the analysis, for scenarios where the incident heat flux is not expected to be constant or to change smoothly and relatively slowly, then an alternative approach would be required to provide a more accurate estimate of the incident radiative heat flux. Suggestions for future work in this area included (Robbins & Collier 2009):

- Investigation of dimensional approaches to heat transfer to replace the lumped parameter assumption.
- Investigation of the use of stability analysis to interpret when the measurement of the plate temperatures is approaching a quasi steady state or not and to estimate the value of the quasi steady state that is being approached.

A.3 Theory – Estimation of the incident radiation for a plate thermometer – New Approach

An alternative approach for estimating the incident radiation that a plate thermometer is subject to was developed as part of this project in order to analyse plate thermometer data fire tests where the incident radiation would not be expected to be constant, and therefore allow time for the response based on previous analysis. This alternative approach is still based on the original suggested by Ingason and Wickstrom (2007) with changes to the assumptions implemented based on the experience and recommendations of Robbins and Collier (2009).

The INCONEL® 600 plate is assumed to be infinitely long and wide (i.e. an infinite plate) relative to the point where the thermocouple is located. One side of the plate is exposed to air and the other has the thermocouple located by an INCONEL® 600 strip, backed with the mineral insulation. A small air gap is located around the thermocouple, between the plate and the insulation. A schematic of the assumed heat transfer associated with a plate thermometer is shown in Figure 122. Where:

- T_P refers to the temperature measured at the surface of the plate thermometer, attached to the plate by the small metal strip (as shown in Figure 119), adjacent to the mineral insulation (K)
- T_S refers to the temperature at the surface of the plate thermometer adjacent to air (K)
- T_I refers to the temperature at the surface of the strip locating the thermometer and the insulation (K)
- δ_{plate} refers to thickness of the plate thermometer (m)
- δ_{air_gap} refers to thickness of the air gap between the (m)
- $\dot{q}_{rad,net}'' = \dot{q}_{rad,inc}'' - \dot{q}_{rad,reflect}'' - \dot{q}_{rad,emit}''$ refers to the net radiation flux received at the surface of the plate (W/m^2)
- $\dot{q}_{rad,inc}''$ refers to the incident radiation flux received at the surface of the plate thermometer (W/m^2)
- $\dot{q}_{rad,reflect}''$ refers to the incident radiation flux reflected at the surface of the plate thermometer (W/m^2)
- $\dot{q}_{rad,emit}''$ refers to the emitted radiation flux from the surface of the plate thermometer to the surrounds (W/m^2)
- \dot{q}_{conv}'' refers to the convective heat flux from the hot surrounding gases to the surface of the plate (W/m^2)
- $\dot{q}_{store,plate}''$ refers to the energy stored in the material of the plate per unit area of the surface of the plate thermometer (W/m^2)
- $\dot{q}_{store,strip}''$ refers to the energy stored in the material of the INCONEL® 600 strip securing the thermocouple to the back of the plate per unit area of the surface of the plate thermometer (W/m^2)
- $\dot{q}_{cond,plate}''$ refers to the conductive heat flux through the metal plate thickness (W/m^2)
- \dot{q}_{cond,air_gap}'' refers to the conductive heat flux through the metal plate thickness (W/m^2)

- $\dot{q}''_{cond,losses}$ refers to an estimate of the combined thermal losses attributed to the plate geometry and the non-adiabatic properties of the mineral insulation (W/m²)
- $\dot{q}''_{cond,1}$ refers to the conductive heat flux losses attributed to the geometry (length and width) of the plate (W/m²), and
- $\dot{q}''_{cond,2}$ refers to the conductive heat flux losses to the mineral insulation (W/m²).

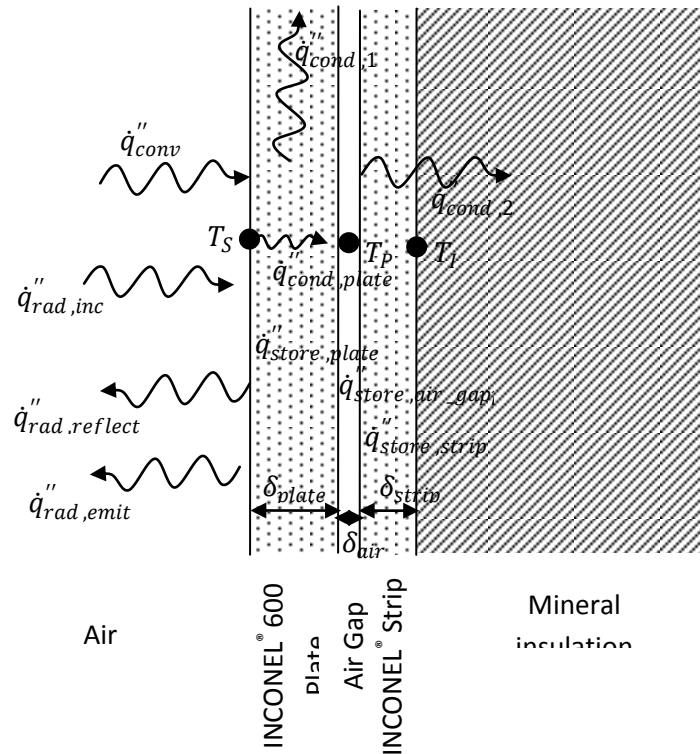

Figure 121: Schematic of heat transfer concerning a plate thermometer, based on the new approach to the analysis. Not to scale.

Similarly to the previous analysis (Ingason and Wickstrom 2007), balancing the energy for the situation shown in Figure 122 provides:

$$\dot{q}''_{tot} = \dot{q}''_{rad,net} + \dot{q}''_{conv} = \dot{q}''_{cond} + \dot{q}''_{store} + \dot{q}''_{cond,losses}$$

Equation 12

Where:

- $\dot{q}''_{store} = \dot{q}''_{store,plate} + \dot{q}''_{store,air_gap} + \dot{q}''_{store,strip}$
- $\dot{q}''_{cond} = \dot{q}''_{cond,plate}$ and
- $\dot{q}''_{cond,losses} = \dot{q}''_{cond,1} + \dot{q}''_{cond,2}$.

Equation 12 can be rewritten as:

$$\begin{aligned} \dot{q}''_{rad,inc} - \dot{q}''_{rad,reflect} - \dot{q}''_{rad,emit} &= \dot{q}''_{cond} + \dot{q}''_{store} + \dot{q}''_{cond,losses} - \dot{q}''_{conv} \\ \dot{q}''_{rad,inc} - (1 - \epsilon_{plate})\dot{q}''_{rad,inc} - \sigma T_s^4 &= \dot{q}''_{cond} + \dot{q}''_{store} + \dot{q}''_{cond,losses} - \dot{q}''_{conv} \\ \dot{q}''_{rad,inc} &= \frac{1}{\epsilon_{plate}} (\dot{q}''_{cond} + \dot{q}''_{store} + \dot{q}''_{cond,losses} - \dot{q}''_{conv}) + \sigma T_s^4 \end{aligned}$$

Equation 13

Where:

- ε_{plate} refers to the emissivity of the plate thermometer (dimensionless), and
- σ refers to the Stefan-Boltzmann constant ($W/m^2 K^4$).

If it is assumed that the temperatures associated with the convection between the plate and the surrounding gas is represented by a film temperature, T_f , where $T_f = (T_\infty + T_S)/2$ and the temperature of the surroundings associated with the conduction losses is ambient (T_∞), then Equation 8 can be rewritten as:

$$\dot{q}_{rad,inc}'' = \frac{1}{\varepsilon_{plate}} \left(k_{plate} \delta_{plate} (T_S - T_P) + \rho_{plate} C_{P,plate} \left[\delta_{plate} \frac{\Delta(T_P + T_S)}{\Delta t} + \delta_{strip} \frac{\Delta(T_P + T_I)}{\Delta t} \right] + \rho_{air} C_{P,air} \delta_{air} \frac{\Delta T_P}{\Delta t} + K_{cond} (T_P - T_\infty) - H_{conv} (T_S - T_\infty) \right) + \sigma T_S^4$$

Equation 14

Where:

- $k_{plate}(T)$ refers to the temperature dependent thermal conductivity of INCONEL[®] 600 ($W/m^2 K$)
- ρ_{plate} refers to the average density of INCONEL[®] 600 (kg/m^3)
- $C_{P,plate}(T)$ refers to the temperature dependent specific heat of INCONEL[®] 600 ($J/kg K$)
- $\rho_{air}(T)$ refers to the temperature dependent density of dry air (kg/m^3)
- $C_{P,air}(T)$ refers to the temperature dependent specific heat of dry ($J/kg K$)
- t refers to time (s)
- K_{cond} represents an estimate for the combined conduction heat transfer coefficients and path length for the conductive heat losses attributed to the geometry of the plate and the non-adiabatic conditions of the mineral insulation ($W/m^2 K$), and
- H_{conv} represents the estimated convective heat transfer coefficient of the plate associated with heat transfer from the surrounding hot gases to the plate thermometer ($W/m^2 K$).

Temperature dependent material properties are summarised in Table 6 and Figure 122 – Figure 125.

The combined heat transfer coefficient for thermal losses, K_{cond} , is estimated based on experimental results for plate thermometers exposed to a target incident radiation using a cone calorimeter for a stove-top of target incident radiation values, similar to the previous approach (Ingason and Wickstrom 2007; Robbins & Collier 2009).

The transfer coefficient of the plate associated with heat transfer from the surrounding hot gases to the plate thermometer, H_{conv} , is based on theory for a vertical isothermal plate exposed to natural convection, using empirical relations for free convection (Holman 1990):

$$H_{conv} = \frac{k_{air} C (Gr_f Pr_f)^m}{L}$$

Equation 15

Where:

- k_{air} refers to the thermal conductivity of dry air (W/m² K)
- Gr_f refers to the Grashof number at the film temperature, T_f , (dimensionless)
- Pr_f refers to the Prandtl number at the film temperature, T_f , (dimensionless)
- L refers to the characteristic length of the plate (m), and
- C and m refer to empirical constants (dimensionless).

The Grashof number is expressed as:

$$Gr_f = \frac{g\beta(T_s - T_\infty)L^3}{\nu^2}$$

Equation 16

Where:

- g refers to gravitational acceleration (m²/s)
- $\beta = 1/T_f$ refers to the temperature coefficient of thermal conductivity (1/K), and
- ν refers to the kinematic viscosity (m²/s) and material properties for dry air were assumed.

The Prandtl number is expressed as:

$$Pr_f = \frac{\nu}{\alpha}$$

Equation 17

Where:

- $\alpha = k/\rho C_p$ refers to thermal diffusivity (m²/s) and, again, material properties for dry air were assumed.

The temperature dependent values for kinematic viscosity and Prandtl number for dry air are summarised in Table 6.

The values for the empirical constants, C and m , are (Holman 1990):

$$\text{if } Gr_f Pr_f = 10^4 - 10^9 \left\{ \begin{array}{l} C = 0.59 \\ m = \frac{1}{4} \end{array} \right.$$
$$\text{if } Gr_f Pr_f = 10^9 - 10^{13} \left\{ \begin{array}{l} C = 0.10 \\ m = \frac{1}{3} \end{array} \right.$$

Equation 18

The flow is considered laminar for $Gr_f Pr_f < 10^9$ and turbulent for $Gr_f Pr_f > 10^9$.

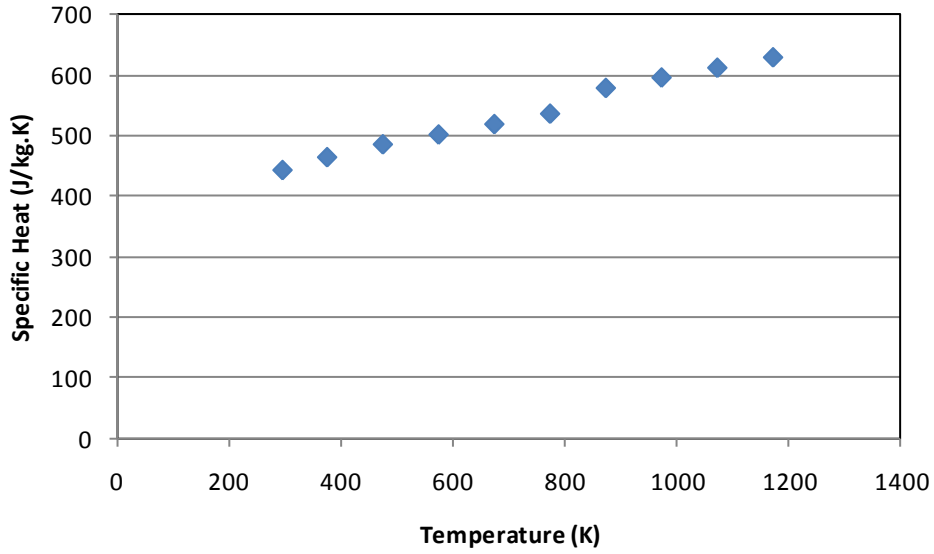

Figure 122: Temperature dependent specific heat values for INCONEL® 600. Adapted from *INCONEL® 600* (2008).

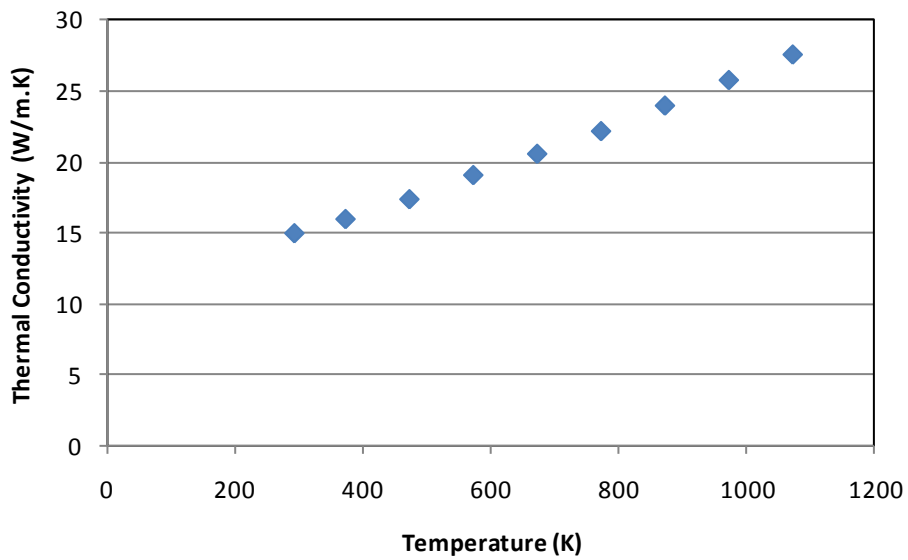

Figure 123: Temperature dependent thermal conductivity values for INCONEL® 600. Adapted from *INCONEL® 600* (2008).

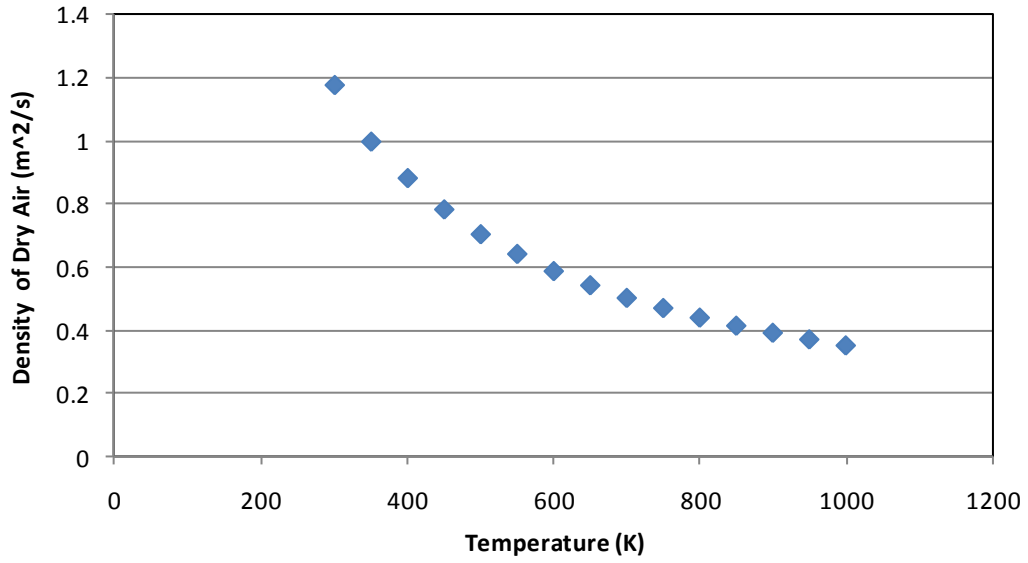

Figure 124: Temperature dependent density values for dry air. Adapted from Holman (1990).

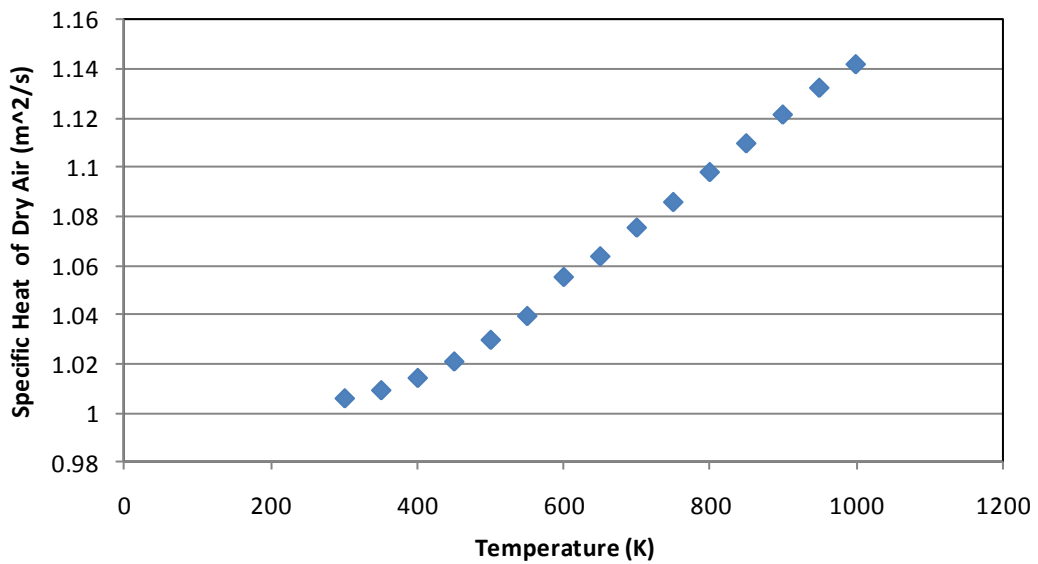

Figure 125: Temperature dependent specific heat values for dry air. Adapted from Holman (1990).

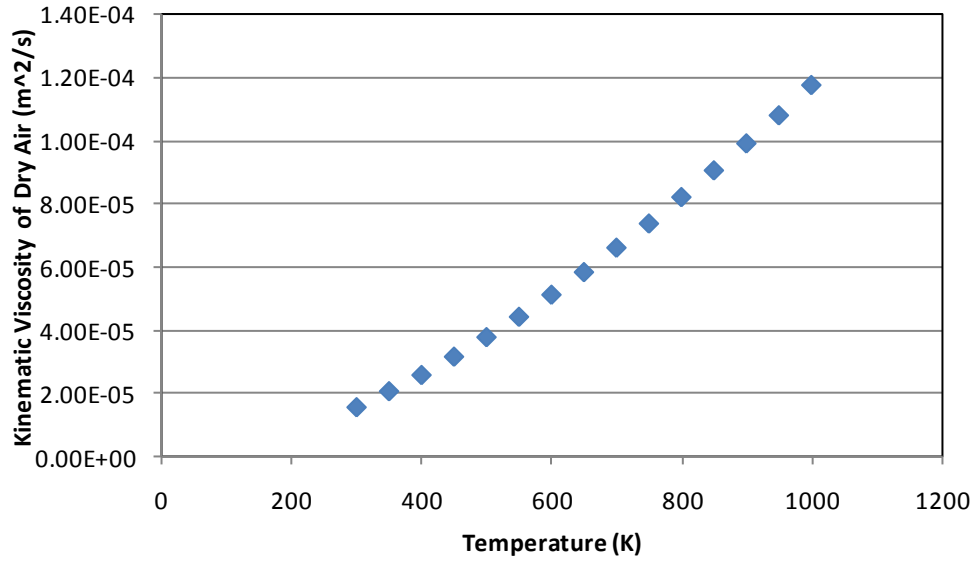

Figure 126: Temperature dependent kinematic viscosity values for dry air. Adapted from Holman (1990).

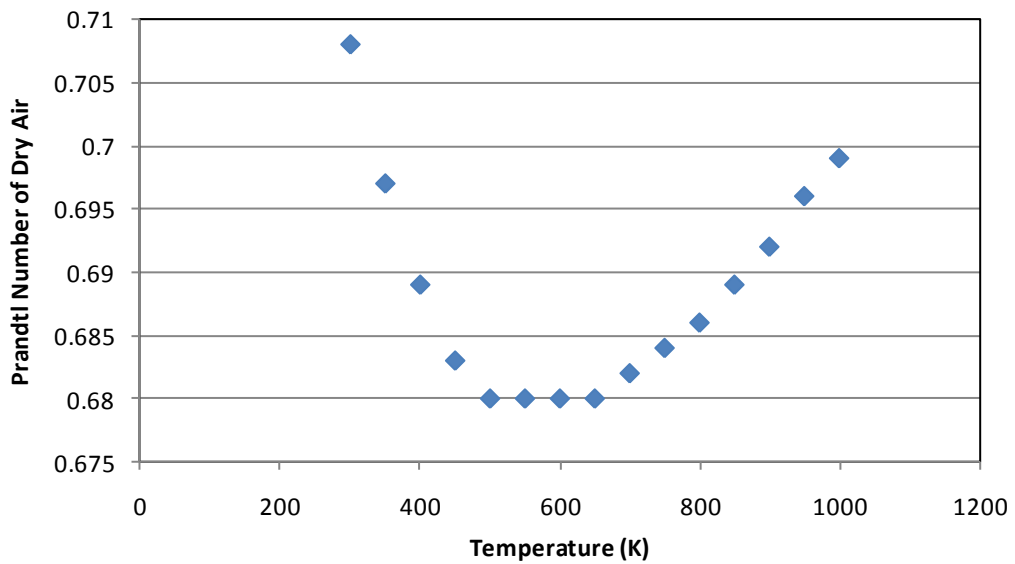

Figure 127: Temperature dependent Prandtl number values for dry air. Adapted from Holman (1990).

Table 6: Summary of the temperature material properties of INCONEL® 600 and dry air.

Variable	Equation
Thermal conductivity of INCONEL® 600 ^a	$k_{plate}(T) = (0.0162T + 9.7841)$
Specific heat of INCONEL® 600 ^a	$C_{P,plate}(T) = (0.2125T + 382.32)$
Density of dry air ^b	$\rho_{air}(T) = (-3.3 \times 10^{-9}T^3 + 7.9 \times 10^{-6}T^2 - 6.91 \times 10^{-3}T + 2.6235)$
Specific heat of dry air ^b	$C_{P,air}(T) = (-3 \times 10^{-10}T^3 + 7.2 \times 10^{-7}T^2 - 3 \times 10^{-4} + 1.03454)$
Kinematic viscosity of dry air ^b	$\nu_{air}(T) = 7 \times 10^{-11}T^2 + 6 \times 10^{-8}T - 0.000009$
Prandtl number for dry air ^b	$Pr_{air}(T) = -3.2 \times 10^{-10}T^3 + 8.1 \times 10^{-7}T^2 - 6.2 \times 10^{-4}T + 0.8296$

Notes:

T is temperature in Kelvin.

^a Adapted from INCONEL® 600 (2008).

^b Adapted from Holman (1990).

Considering the surface temperature of the plate thermometer, T_s , is not equal to the measured plate thermometer temperature, T_p , then the heat transfer across the plate of the plate thermometer in one dimension is represented by:

$$\frac{\partial T}{\partial x} = \frac{k_{plate}}{C_{P,plate}\rho_{plate}} \frac{\partial^2 T}{\partial x^2}$$

$$T(x, 0) = f(x)$$

$$T(0, t) = T_s(t)$$

$$T(\delta_{plate}, t) = T_p(t)$$

Equation 19

Where:

- $T(x, t)$ represents the temperature within the plate of the plate thermometer at time, t , and distance from the surface exposed to the surrounding gases, x ,
- x represents the dimension through the thickness of the plate of the plate thermometer, and
- $f(x)$ represents the initial distribution of temperature through the thickness.

Trying a solution of the form $T(x, t) = X(x)U(t)$, then using separation of variables Equation 16 can be rewritten as:

$$\frac{U'(t)}{\alpha U(t)} = \frac{X''(x)}{X(x)} = -\lambda$$

Equation 20

Where λ is a constant.

Then the solution takes the general form:

$$U'(t) = -\lambda\alpha U(t) \rightarrow U(t) = Ae^{-\lambda\alpha t}$$

$$X''(x) = -\lambda X(x) \rightarrow X(x) = B \sin(\sqrt{\lambda}x) + C \cos(\sqrt{\lambda}x)$$

Equation 21

Where λ must be a positive, real number.

Applying initial and boundary conditions and assuming $\lambda = (n\pi/L)^2$, results in the solution:

$$T(x, t) = T(0, t) + (T(x, 0) - T(0, t)) \sum_{n=0}^{\infty} a_n e^{-(\frac{n\pi}{L})^2 at} \sin\left(\frac{n\pi x}{2L}\right)$$

Equation 22

When $a_n = \begin{cases} \frac{4}{n\pi}, n \text{ odd} \\ 0, n \text{ even} \end{cases}$ and the $n = 1$ term dominates the solution.

Which can be used to estimate the value for the surface temperature of the plate thermometer, $T(0, t) = T_S(t)$, based on the measured value for the plate thermometer, $T_P(t)$:

$$T(0, t) = \frac{T(x, t) - T(x, 0) \sum_{n=0}^{\infty} a_n e^{-(\frac{n\pi}{L})^2 at} \sin\left(\frac{n\pi x}{2L}\right)}{1 - \sum_{n=0}^{\infty} a_n e^{-(\frac{n\pi}{L})^2 at} \sin\left(\frac{n\pi x}{2L}\right)}$$

$$T_S(t) = \frac{T_P(t) - T_P(0) \sum_{n=0}^{\infty} a_n e^{-(\frac{n\pi}{L})^2 at} \sin\left(\frac{n\pi \delta_{plate}}{2L}\right)}{1 - \sum_{n=0}^{\infty} a_n e^{-(\frac{n\pi}{L})^2 at} \sin\left(\frac{n\pi \delta_{plate}}{2L}\right)}$$

Equation 23

A.3.1 Summary of assumptions

In summary, the error associated with the new approach is dependent on the assumptions:

- The plate thermometer, from the perspective of the measurement thermocouple, can be described by an infinite plate (i.e. there is negligible deviation of temperature over the surface compared to the centre, where the thermocouple is located),
- The surface temperature is the same as the temperature between the metal plate and the backing insulation ($T_S = T_P$),
- The temperature between the metal locating strip and the insulation is the same as the temperature between the metal plate and the locating strip ($T_I = T_P$)
- The convection heat transfer coefficient (H_{conv}) can be estimated by the theory for a vertical plate under natural convection conditions (although the experiments performed here use the plate thermometers in a vertical orientation and some mixing) resulting in localised turbulent flow, which is expected in the ISO room experiments compared to a theoretically isolated plate,
- The local gas temperature is assumed to be a film temperature that is the average of the surface of the plate thermometer and ambient temperatures ($T_{local\ gas} = T_f = (T_S + T_{\infty})/2$),

- The temperature throughout the backing insulation is assumed to be ambient ($T_{insulation} = T_{\infty}$),
- The loss of heat to the insulation and the non-one-dimensional heat transfer through the metal Plate Can be estimated by an effective lumped conduction heat transfer coefficient (K_{cond}). This lumped coefficient is assumed to be temperature independent and is estimated using experimental data from a calibration phase.
- Material properties of the gases around the plate thermometer can be represented by those for dry air,

A.3.2 Summary of the Parameter Values Used in Analysis

A summary of the other parameter values used in the analysis is included in Table 7.

Table 7: Summary of constant parameter values used in calculations.

Parameter	Value
Plate emissivity	0.85
Plate thickness	0.85 mm
Average plate density	8500 kg/m ³
Characteristic length of plate	0.1 m
Effective thermal conductivity constant	6 W/m ² .K
Stefan Boltzmann constant	5.68x10 ⁻⁸ W/m ² .K

A.3.3 Comparison of Results for the Two Analysis Approaches

Using calibration experiments performed in the cone calorimeter (Robbins and Collier 2009), the results for the two types of analysis approaches discussed here were compared. The following is a summary of this comparison.

‘Approach A’ is used to describe the results associated with the analysis presented in Section A.2, and ‘Approach B’ is used to describe the results associated with the analysis presented in Section A.3.

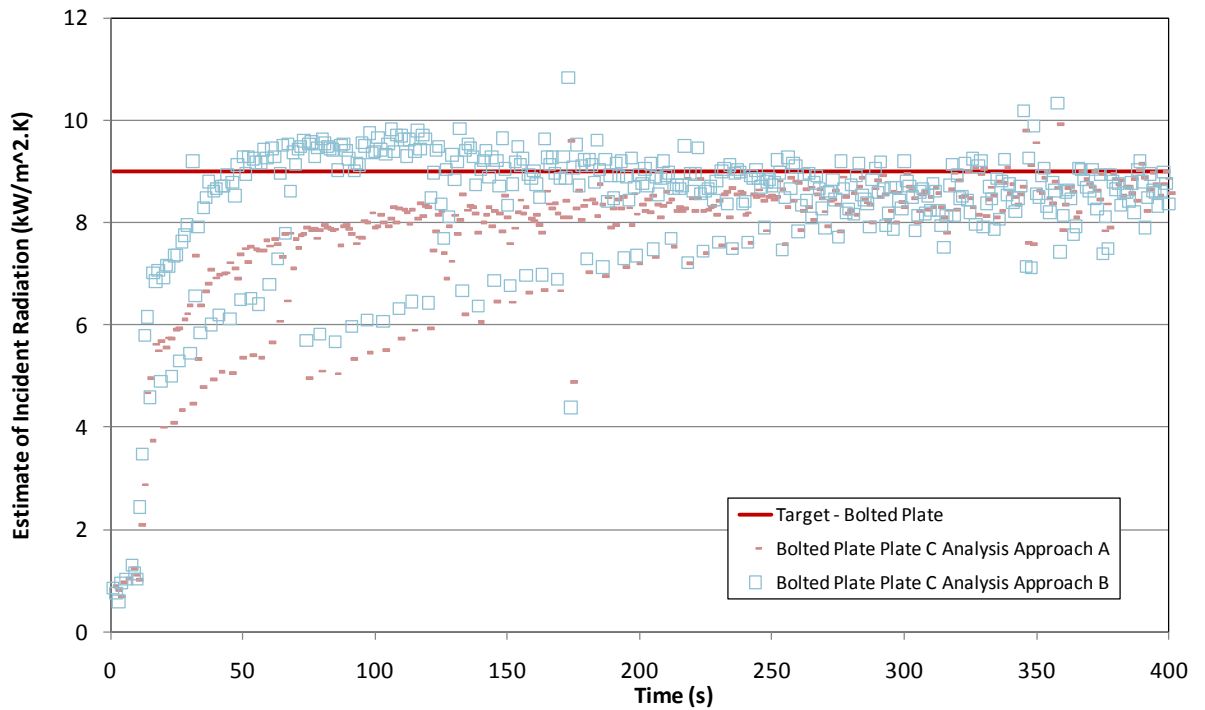

Figure 128: Comparison of the two analysis approaches for a bolted plate thermometer subjected to a target incident radiation of 9 kW/m².K.

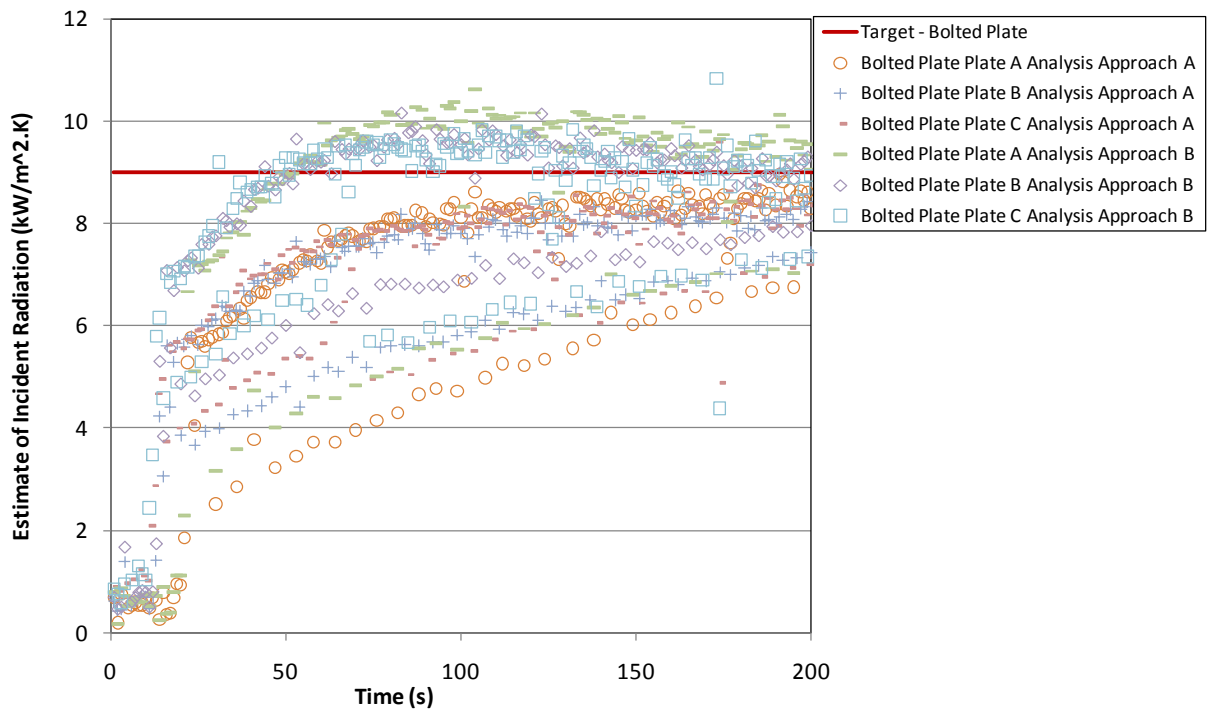

Figure 129: Comparison of the two analysis approaches for three bolted plate thermometers subjected to a target incident radiation of 9 kW/m².K.

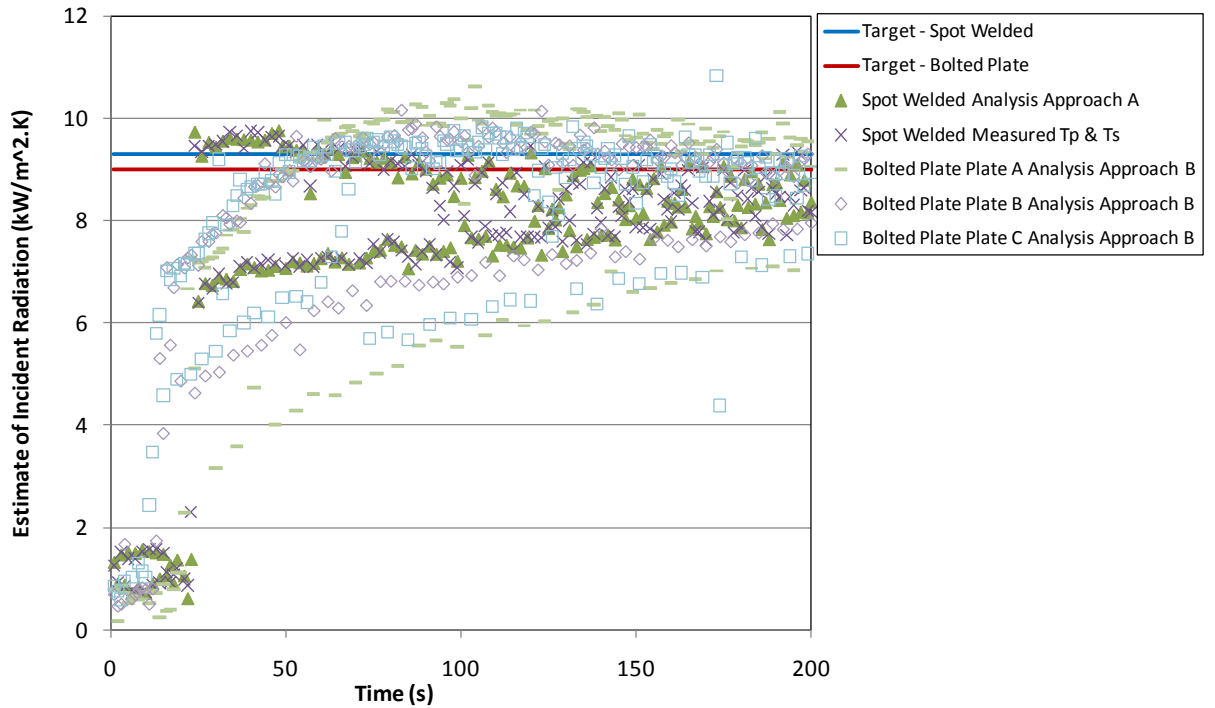

Figure 130: Comparison of analysis approach B for three bolted plate thermometers subjected to a target incident radiation of 9 kW/m².K and results from analysis approach A for a spot welded plate thermometer subjected to a target incident radiation of 9.4 kW/m².K.

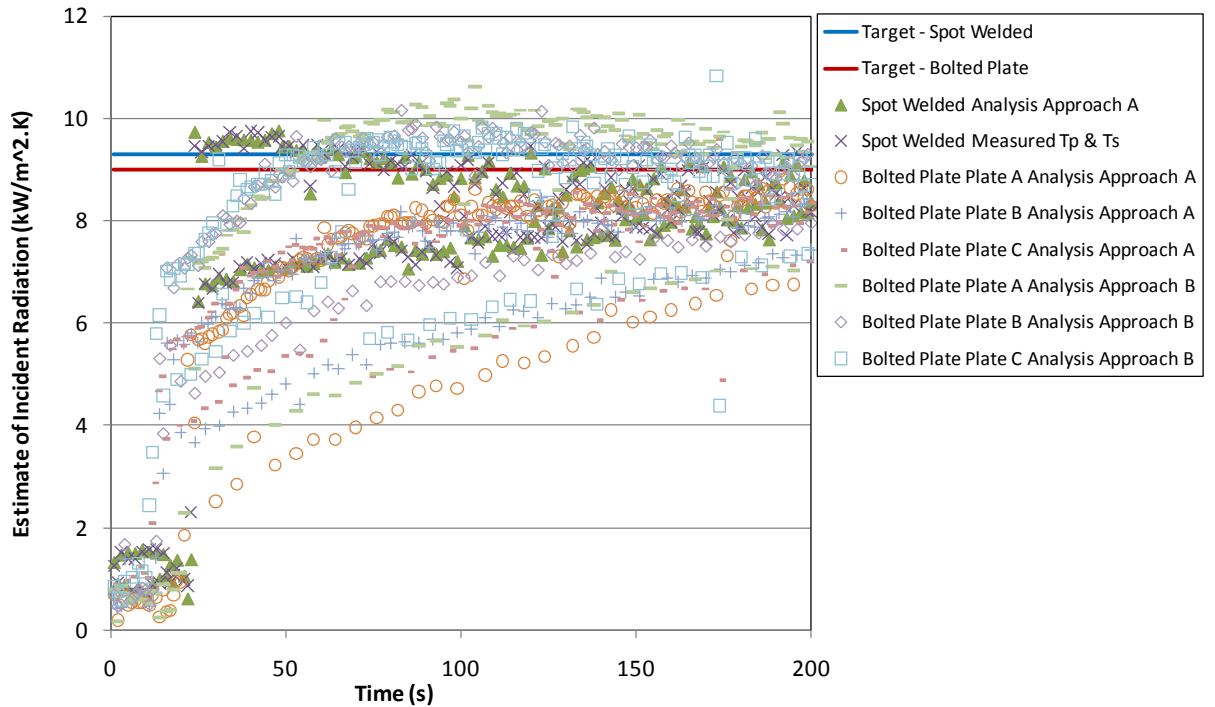

Figure 131: Comparison of the two analysis approaches for three bolted plate thermometers subjected to a target incident radiation of 9 kW/m².K and results from analysis approach A for a spot welded plate thermometer subjected to a target incident radiation of 9.4 kW/m².K.

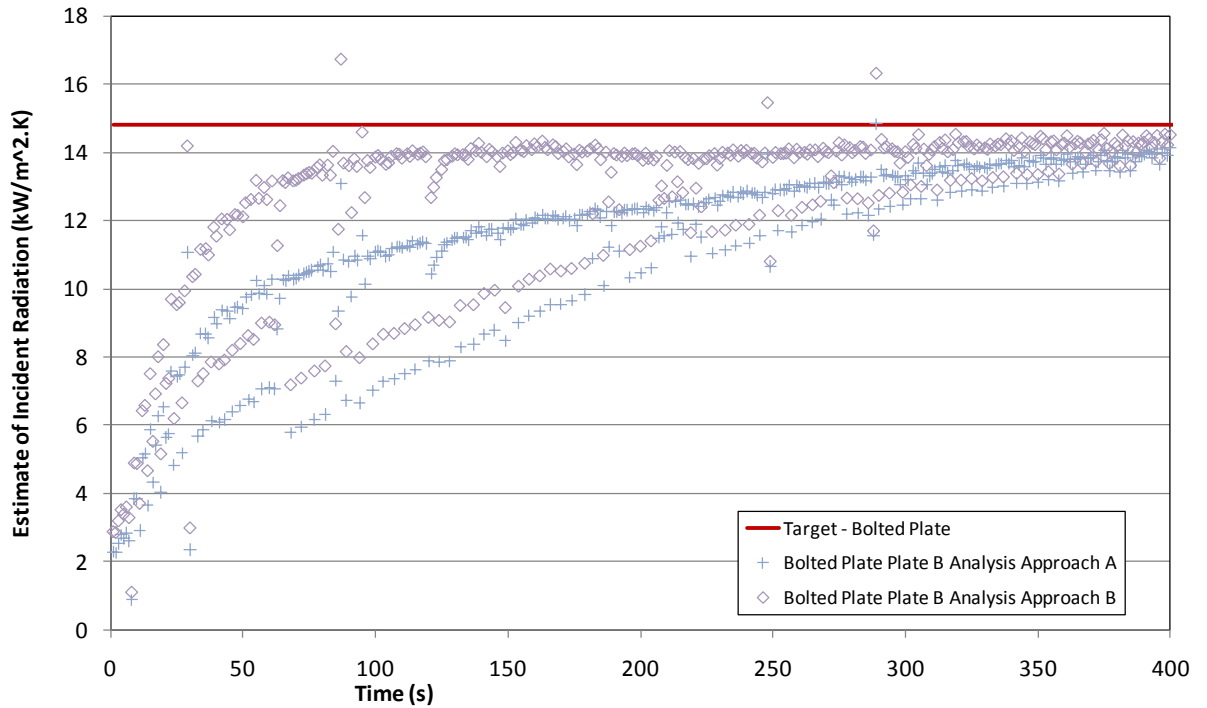

Figure 132: Comparison of the two analysis approaches for a bolted plate thermometer subjected to a target incident radiation of 14.8 kW/m².K.

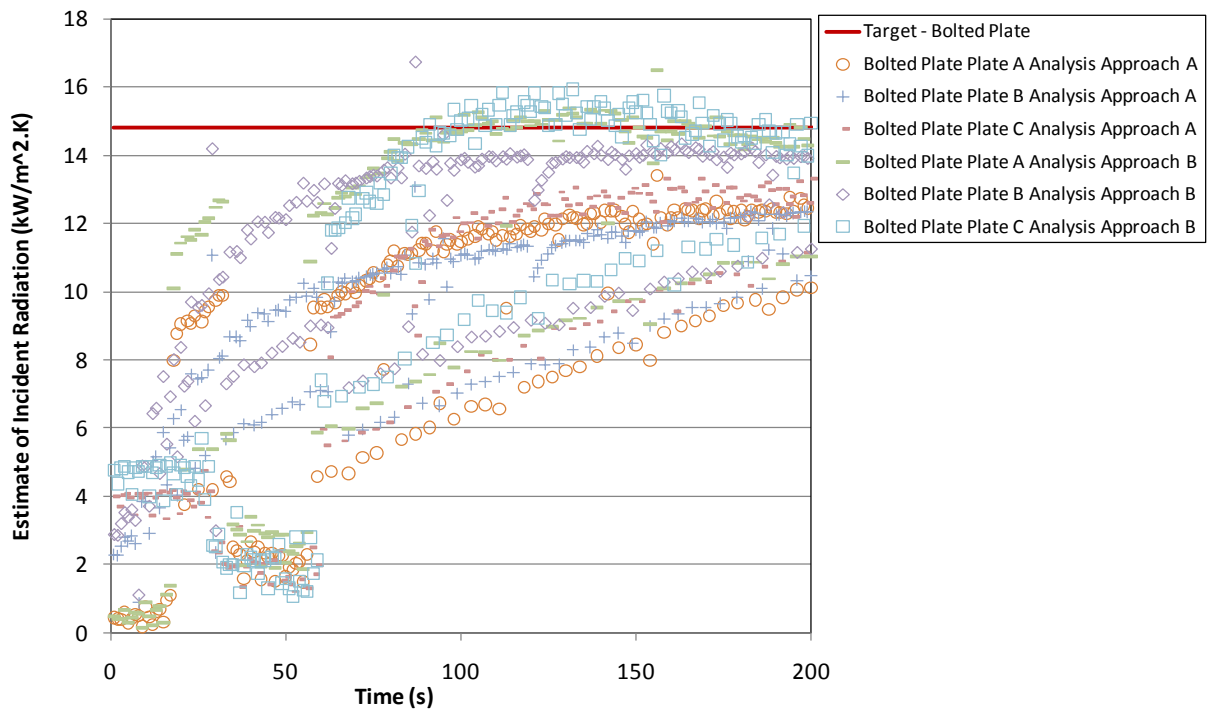

Figure 133: Comparison of the two analysis approaches for three bolted plate thermometers subjected to a target incident radiation of 14.8 kW/m².K.

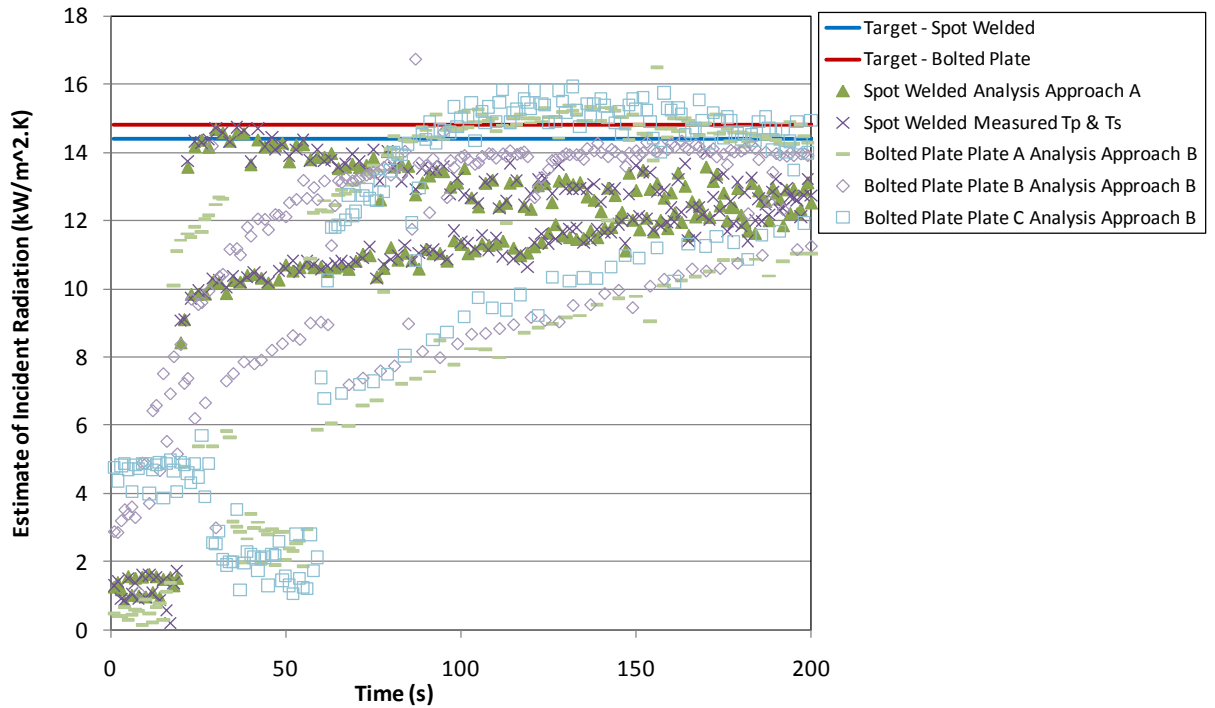

Figure 134: Comparison of analysis approach B for three bolted plate thermometers subjected to a target incident radiation of 14.8 kW/m².K and results from analysis approach A for a spot welded plate thermometer subjected to a target incident radiation of 14.4 kW/m².K.

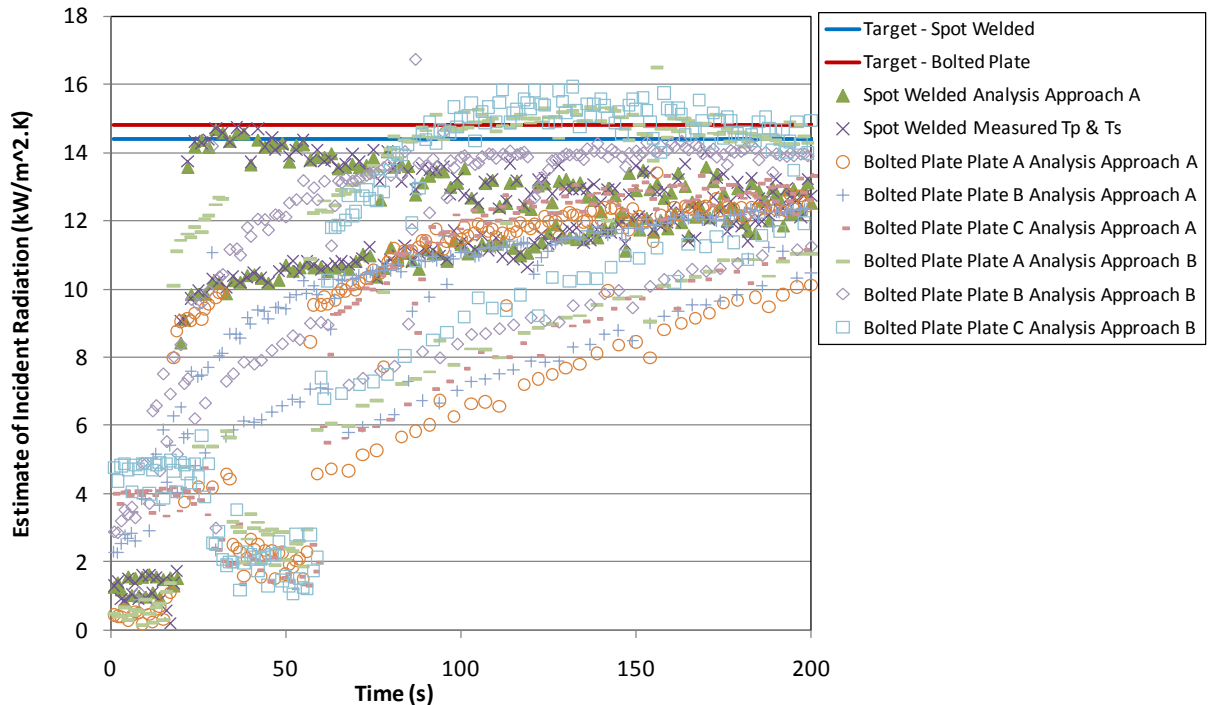

Figure 135: Comparison of the two analysis approaches for three bolted plate thermometers subjected to a target incident radiation of 14.8 kW/m².K and results from analysis approach A for a spot welded plate thermometer subjected to a target incident radiation of 14.4 kW/m².K.

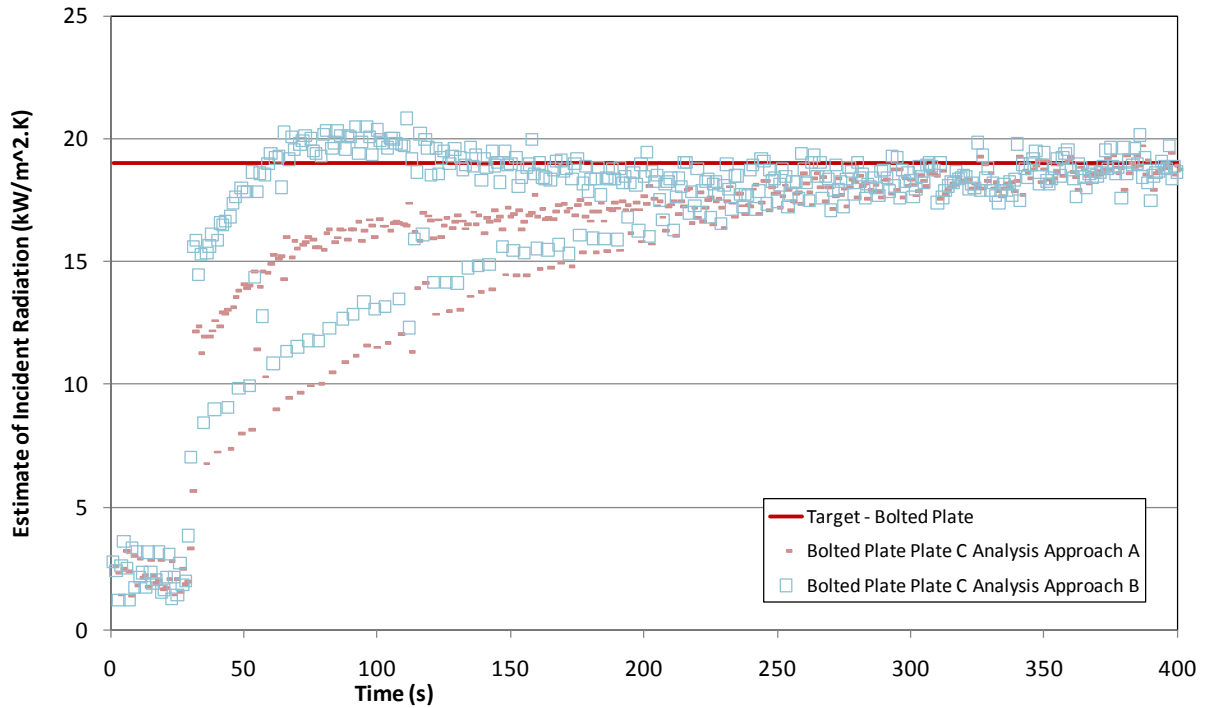

Figure 136: Comparison of the two analysis approaches for a bolted plate thermometer subjected to a target incident radiation of 19.0 kW/m².K.

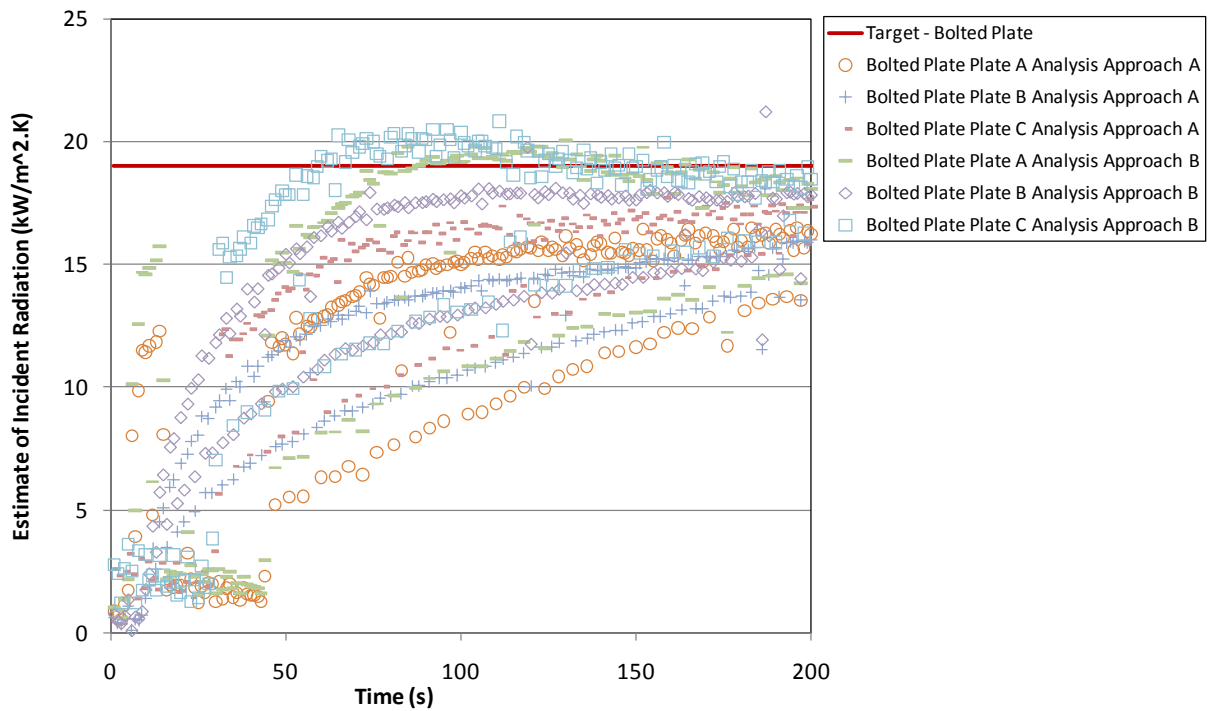

Figure 137: Comparison of the two analysis approaches for three bolted plate thermometers subjected to a target incident radiation of 19.0 kW/m².K.

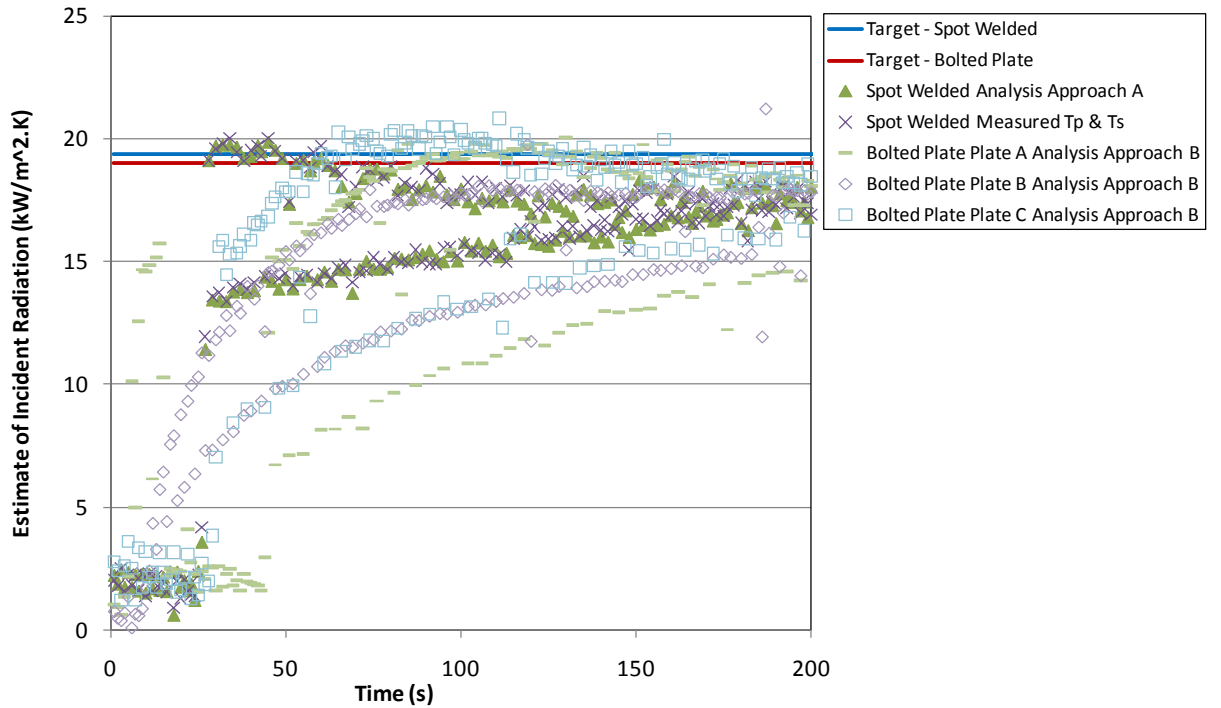

Figure 138: Comparison of analysis approach B for three bolted plate thermometers subjected to a target incident radiation of $19.0 \text{ kW/m}^2\cdot\text{K}$ and results from analysis approach A for a spot welded plate thermometer subjected to a target incident radiation of $19.4 \text{ kW/m}^2\cdot\text{K}$.

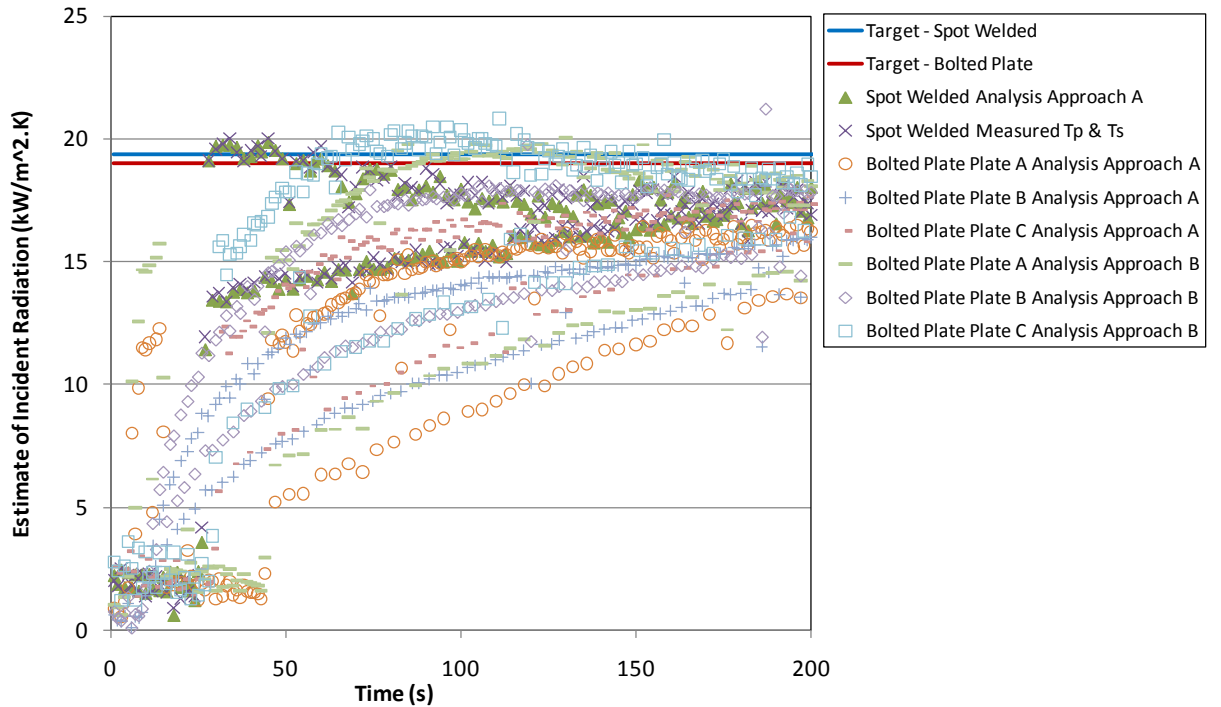

Figure 139: Comparison of the two analysis approaches for three bolted plate thermometers subjected to a target incident radiation of $19.0 \text{ kW/m}^2\cdot\text{K}$ and results from analysis approach A for a spot welded plate thermometer subjected to a target incident radiation of $19.4 \text{ kW/m}^2\cdot\text{K}$.

APPENDIX B LIST OF KITCHEN FIRE TESTS

Table 8: Summary of kitchen stove-top fire tests

Test No.	Vessel	Volume of Oil	Type of Oil	Food Present in Vessel	Wet/Dry Pan	HRR	Fire Protection System	Electric/Gas Element	Element Power During Flaming	Stove-top TC	Corridor	Baffle	Wet/Dry Corridor	Ceiling TC
1	small pan	200 ml	canola	-	dry	off	Damp towel, de-energize element	gas	on	-	-	-	-	-
2	small pan	200 ml	canola	-	dry	off	Damp towel, de-energize element	gas	on	-	-	-	-	-
3	small pan	200 ml	canola	-	dry	off	Damp towel, de-energize element	gas	on	-	-	-	-	-
4	small pan	200 ml	peanut	-	dry	off	Damp towel, de-energize element	gas	on	-	-	-	-	-
5	skillet	200 ml	canola	-	dry	off	Damp towel, de-energize element	gas	on	-	-	-	-	-
6	skillet	200 ml	canola	-	dry	on				-				
7	skillet	200 ml	canola	-	dry	on	-	electric	on	-	-	-	-	-
8	skillet	200 ml	canola	-	dry	on	-	electric	on	-	-	-	-	-

9	skillet	200 ml	canola	-	dry	on	-	electric	on	-	-	-	-	-
10	skillet	200 ml	peanut	-	dry	-	-	electric	on	-	-	-	-	-
11	skillet	200 ml	peanut	-	dry	on	-	electric	on	A-E	-	-	-	-
12	skillet	200 ml	peanut	-	dry	on	-	electric	on	A-E	-	-	-	-
13	small pan	200 ml	canola	-	dry	on	-	electric	on	A-E	-	-	-	-
14	small pan	200 ml	canola	-	dry	on	-	electric	on	A-E	-	-	-	-
15	small pan	200 ml	canola	-	dry	on	-	electric	on	A-E	-	-	-	-
16	skillet	400 ml	canola	-	dry	on	-	electric	on	A-E	-	-	-	-
17	skillet	400 ml	canola	-	dry	on	-	electric	on	A-E	-	-	-	-
18	skillet	400 ml	canola	-	dry	on	-	electric	on	A-E	-	-	-	-
19	stock pot	200 ml	canola	-	dry	on	-	electric	on	A-E	-	-	-	-
20	stock pot	200 ml	canola	-	dry	on	-	electric	on	A-E	-	-	-	-
21	stock pot	200 ml	canola	-	dry	on	-	electric	on	A-E	-	-	-	-
22	skillet	200 ml	canola	bacon	dry	on	-	electric	on	A-E	-	-	-	-
23	skillet	200 ml	canola	bread	dry	on	-	electric	on	A-E	-	-	-	-

24	skillet	200 ml	canola	potatoes	dry	on	-	electric	on	A-E	-	-	-	-
25	skillet	200 ml	canola	potatoes	dry	on	-	electric	on	A-E	-	-	-	-
26	skillet	200 ml	canola	-	dry	on	-	electric	on	A-E	-	-	-	-
27	aborted													
28	skillet	empty	-	-	dry	off	-	electric	on	A-E	-	-	-	-
29	skillet	200 ml	canola	-	wet	off	-	electric	on	A-E	-	-	-	-
30	skillet	200 ml	canola	-	dry	off	-	electric	on	A-E	-	-	-	-
31	skillet	200 ml	canola	-	dry	off	-	electric	on	A-E	-	-	-	-
32	skillet	200 ml	canola	cup of water 10s after ignition	dry	on	-	electric	on	A-E	-	-	-	-
33	skillet	200 ml	canola	cup of water 10s after ignition	dry	on	-	electric	on	A-E	-	-	-	-
34	skillet	200 ml	canola	cup of water 10s after ignition	dry	on	-	electric	on	A-E	-	-	-	-
35	skillet	200 ml	canola	-	dry	on	de-energize stove only	electric	de-energized	E missing	-	-	-	-
36	skillet	200 ml	canola	-	wet	on	de-energize	electric	de-energized	E	-	-	-	-

							stove only			missing				
37	skillet	200 ml	canola	-	dry	on	de-energize stove only	electric	de-energized	A-E	-	-	-	-
38	skillet	200 ml	canola	-	dry	on	fire blanket & de-energize	electric	de-energized	A-E	-	-	-	-
39	skillet	200 ml	canola	-	dry	on	fire blanket & de-energize	electric	de-energized	no B,D & E TC's	-	-	-	-
40	skillet	200 ml	canola	-	dry	on	fire blanket & de-energize	electric	de-energized	no B,D & E TC's for first part of test, moved back into place at end of test	-	-	-	-
41	skillet	200 ml	canola	-	dry	on	fireblanket & de- energize	electric	off after extinguishment	A-E	-	-	-	-
42	skillet	200 ml	canola	-	dry	on	fireblanket & de- energize (burnt through used parts of fire blanket)	electric	off after extinguishment	A-E	-	-	-	-
43	skillet	200 ml	canola	-	wet	on	-	electric	on	A-E	-	-	-	-
44	skillet	200 ml	canola	-				electric						

45	skillet	200 ml	canola	-	dry	on	Extinguisher A	electric	de-energized	A-E	-	-	-	-
46	aborted													
47	skillet	200 ml	canola	-	dry	crashed	Extinguisher B	electric	de-energized	A-E	-	-	-	-
48	skillet	200 ml	canola	-	dry	on	Extinguisher C	electric	de-energized	A-E	-	-	-	-
49	skillet	200 ml	canola	-	dry	on	-	electric	de-energized	A-E	yes	no	dry	-
50	skillet	200 ml	canola	-	dry	on	-	electric	de-energized	A-E	yes	no	dry	3 ceiling TC's (1700, 770, 440 (above pan) from wall)
51	skillet	200 ml	canola	-	dry	on	-	electric	de-energized	A-E	yes	no	dry	3 ceiling TC's (1700, 770, 440 (above pan) from wall)
52	skillet	200 ml	canola	-	dry	off	-	electric	de-energized	A-E	yes	no	dry	3 ceiling TC's (1700, 770, 440 (above pan) from wall)
53	skillet	200 ml	canola	-	dry	off	sprinkler	electric	on	A-E	yes	no	dry	3 ceiling TC's (1700, 770, 440 (above pan) from pan)
54	skillet	200 ml	canola	-	dry	on	-	electric	de-energized after ignition	A-E	yes	no	wet	3 ceiling TC's (1500, 770, 440 (above pan) from wall)

55	skillet	200 ml	canola	-	dry	on	-	electric	on	A-E	yes	no	wet	3 ceiling TC's (1500, 770, 440 (above pan) from wall)
56	skillet	200 ml	canola	-	dry	on	-	electric	de-energized after ignition	A-E	yes	yes	dry	3 ceiling TC's (1500, 770, 440 (above pan) from wall)
57	skillet	200 ml	canola	-	dry	on	sprinkler	electric	on	A-E	yes	yes	dry	3 ceiling TC's (1500, 770, 440 (above pan) from wall)
58	skillet	200 ml	canola	-	wet	on	sprinkler	electric	on	A-E	yes	yes	wet	3 ceiling TC's (1500, 770, 440 (above pan) from wall)
59	skillet	200 ml	canola	-	dry	on	-	electric	on	A-E	yes	yes	wet	3 ceiling TC's (1500, 770, 440 (above pan) from wall)
60	skillet	200 ml	canola	-	dry	on	sprinkler	electric	on	A-E	yes	yes	dry	3 ceiling TC's (1500, 770, 440 (above pan) from wall)
61	skillet	200 ml	canola	-	dry	off	-	electric	on	A-E	yes	yes	wet	3 ceiling TC's (1500, 770, 440 (above pan) from wall)

62	skillet	200 ml	canola	-	dry	off	-	electric	on	A-E	yes	yes	wet	3 ceiling TC's (1500, 770, 440 (above pan) from wall)
63	skillet	200 ml	canola	-	dry	off	-	electric	on	A-E	yes	yes	wet	3 ceiling TC's (1500, 770, 440 (above pan) from wall)
64	skillet	200 ml	canola	-	dry	off	sprinkler	electric	on	A-E	yes	yes	wet	3 ceiling TC's (1500, 770, 440 (above pan) from wall) TC on sprinkler head fell off
65	skillet	200 ml	canola	-	dry	off	sprinkler	electric	on	A-E	yes	yes	wet	3 ceiling TC's (1500, 770, 440 (above pan) from wall)
66	skillet	200 ml	canola	-	dry	off	sprinkler	electric	on	A-E	yes	yes	wet	3 ceiling TC's (1500, ?, ?(above pan) from wall)
67	skillet	400 ml	canola	-	dry	on	-	electric	on	A-E	yes	yes	wet	3 ceiling TC's (1500, 770, 440 (above pan) from wall)
68	skillet	400 ml	canola	-	dry	on	-	electric	on	A-E	yes	yes	wet	3 ceiling TC's (1500, 770, 440 (above pan)

														from wall)
69	skillet	400 ml	canola	-	dry	on	-	electric	on	A-E	yes	yes	wet	3 ceiling TC's (1500, 770, 440 (above pan) from wall)
70	skillet	400 ml	canola	-	dry	on	sprinkler	electric	on	A-E	yes	yes	wet	3 ceiling TC's (1500, 770, 440 (above pan) from wall)

APPENDIX C SUMMARY OF TEST OBSERVATIONS

The times used here are associated with the original experimental data, as included in Appendix D, and not associated with the times used in the results shown in Section 4.

Table 9: Summary of observations during kitchen stove-top fire tests

Test No.	Vessel	Volume of Oil	Type of Oil	Fire Protection System	Time to Ignition	Time to Fire Protection Application or Activation	Time to Element De-energized	Time to Flameout	Other Observations
1	small pan	200 ml	canola	Damp towel, de-energize element	597	605	610	Re-ignition	Damp towel removed & oil subsequently re-ignited.
2	small pan	200 ml	canola	Damp towel, de-energize element	517	519	524	Re-ignition	Damp towel removed & oil subsequently re-ignited, Re-ignition at 657, 723, 836 , 927 s
3	small pan	200 ml	canola	Damp towel, de-energize element	543	545	547	Re-ignition	Damp towel removed & oil subsequently re-ignited, Re-ignition at 727 and 849 s
4	small pan	200 ml	peanut	Damp towel, de-energize element	595	599	301	Re-ignition	Damp towel removed & oil subsequently re-ignited
5	skillet	200 ml	canola	-	802	-	840		
6	skillet	200 ml	canola		592		1766		
7	skillet	200 ml	canola	-	888	-	1146	1061	
8	skillet	200 ml	canola	-	603	-	873	763	
9	skillet	200 ml	canola	-	849	-	1219	1005	

10	skillet	200 ml	peanut	-	739	-	1049	893	
11	skillet	200 ml	peanut	-	753	-	1173	817	
12	skillet	200 ml	peanut	-	624	-	877	763	
13	small pan	200 ml	canola	-	750	-	1000	906	
14	small pan	200 ml	canola	-	1482	-	1811	1808	pan bottom buckled from heat so not sitting flat on element
15	small pan	200 ml	canola	-	1326	-	1700	1688	pan bottom still buckled so not sitting flat on element
16	skillet	400 ml	canola	-	1059	-	1409	1246	
17	skillet	400 ml	canola	-	1044	-	1414	1230	cleaned thermocouples at beginning of test
18	skillet	400 ml	canola	-	1067	-	1435	1255	rewired element TC, adjusted element during beginning of test
19	stock pot	200 ml	canola	-	495	-	943	710	boilover at 720 s
20	stock pot	200 ml	canola	-	504	-	80	708	lab door open during test
21	stock pot	200 ml	canola	-	511	-	733	667	flames up and down from 671 s
22	skillet	200 ml	canola	-	798	-	1158	962	lots of spitting oil before ignition, small fires around outside of pan from spat oil, bacon bump continued to flame at end of test
23	skillet	200 ml	canola	-	810	-	1198	993	no spitting of oil during test, flames continued on the burnt bread at end of test

24	skillet	200 ml	canola	-		1336 -	1703	1475	adjusted element @ 330s, removed water from under element @480s, spitting oil before ignition, adjusted element again @ 1050s
25	skillet	200 ml	canola	-		1265 -	1633	1379	spitting oil before ignition
26	skillet	200 ml	canola	-		804 -	1144	942	problem with element heating, started test video @ 141s
27	aborted								
28	skillet	empty	-	-	N/A	-	1016	N/A	stove with skillet by itself, so no flaming observed
29	skillet	200 ml	canola	-		820 -	1110	920	lots of hissing & popping @100s, smoke leaking out of under hood @579s, top PT fell off stand @680s, mineral wool at back of pan alight w spattered oil @724s out @760s
30	skillet	200 ml	canola	-		904 -	1192	1007	element connection problem at start, oil TC out of oil @ 1114s
31	skillet	200 ml	canola	-		605 -	893	710	
32	skillet	200 ml	canola	-		657 -	865	705	boilover with addition of water
33	skillet	200 ml	canola	-		768 -	857	805	with addition of water spitting restarted @940s
34	skillet	200 ml	canola	-		283 -	555	472	oil TC was out of oil until just prior to ignition, boilover @322s as water applied, very vigorous @445, power cut to PC and datalogger

35	skillet	200 ml	canola	de-energize stove only	823	-	834	954	lower flow in duct
36	skillet	200 ml	canola	de-energize stove only	564	-	583	708	faster flow in duct
37	skillet	200 ml	canola	de-energize stove only	517	-	550	666	
38	skillet	200 ml	canola	fire blanket & de-energize	587	591	597	591	bad smell from blanket, smoke coming from top of blanket might have been coming through blanket, smoke stinging eyes, removed blanket @ 720s, small flames visible under blanket, occasional flames from edge of blanket
39	skillet	200 ml	canola	fire blanket & de-energize	876	878	895	878	adjusted oil TC @585s, a lot of acrid smoke coming off blanket
40	skillet	200 ml	canola	fire blanket & de-energize	710	731	749	731	restarted glow under blanket @ 890s
41	skillet	200 ml	canola	fireblanket & de-energize	783	823	825	823	stove located close to one side of hood
42	skillet	200 ml	canola	fireblanket & de-energize (burnt through used parts of fire blanket)	785	793	799	1410	stove located close to one side of hood
43	skillet	200 ml	canola	-	700	-	995	848	TC 100mm above pan playing up
44	aborted								

45	skillet	200 ml	canola	Extinguisher A	1424	1434	1434	1493	100mm TC fixed & stove restarted @ 580s, splash of oil from extinguisher, extinguisher used at about 2 m from pan/fire as per instructions, TC B fell out during test at some stage, lots of smoke after extinguisher used & power off, reignited @ 1477s, extinguisher reapplied, still lots of smoke, smoke thinning @ 1679s
46	aborted								
47	skillet	200 ml	canola	Extinguisher B	611	727	979	859	HRR logging crashed, splash of oil when extinguisher applied
48	skillet	200 ml	canola	Extinguisher C	669	686	733	742	Extinguisher powder formed a more solid foam layer on top of the oil fire than the other extinguishers
49	skillet	200 ml	canola	-	835	-	864	1065	element power off after ignition, sprinkler installed
50	skillet	200 ml	canola	-	754	-	765	945	HRR data crashed out on saving, sprinkler installed
51	skillet	200 ml	canola	-	645	-	731	816	sprinkler installed
52	skillet	200 ml	canola	-	547	-	551	769	sprinkler installed
53	skillet	200 ml	canola	sprinkler	630	656	773	760	sprinkler installed
54	skillet	200 ml	canola	-	1045	-	1130	1180	
55	skillet	200 ml	canola	-	670	-	1105	825	

56	skillet	200 ml	canola	-	750	-	769	900	
57	skillet	200 ml	canola	sprinkler	620	663	800	712	
58	skillet	200 ml	canola	sprinkler	645	693	754	711	
59	skillet	200 ml	canola	-	710	-	1098	870	
60	skillet	200 ml	canola	sprinkler	860	906	947	920	
61	skillet	200 ml	canola	-	870	-	1543	1030	
62	skillet	200 ml	canola	-	854	-	1113	970	
63	skillet	200 ml	canola	-	905	-	1162	1055	
64	skillet	200 ml	canola	sprinkler	770	795	865	841	
65	skillet	200 ml	canola	sprinkler	790	808	991	864	
66	skillet	200 ml	canola	sprinkler	653	707	775	755	
67	skillet	400 ml	canola	-	1060	-	1389	1250	
68	skillet	400 ml	canola	-	1095	-	1558	1317	burning on mineral wool behind pan (at TC C)
69	skillet	400 ml	canola	-	1070	-	1474	1310	
70	skillet	400 ml	canola	sprinkler	950	963	1126	994	

APPENDIX D DETAILS OF KITCHEN FIRE RESULTS

The list of tests is included in Table 8 of Appendix B.

Appendix D is included in a separate file.

APPENDIX E ESTIMATING FIRE PROTECTION EFFECTIVENESS

E.1 Average Test Results for the Free-Burning Challenge Scenario

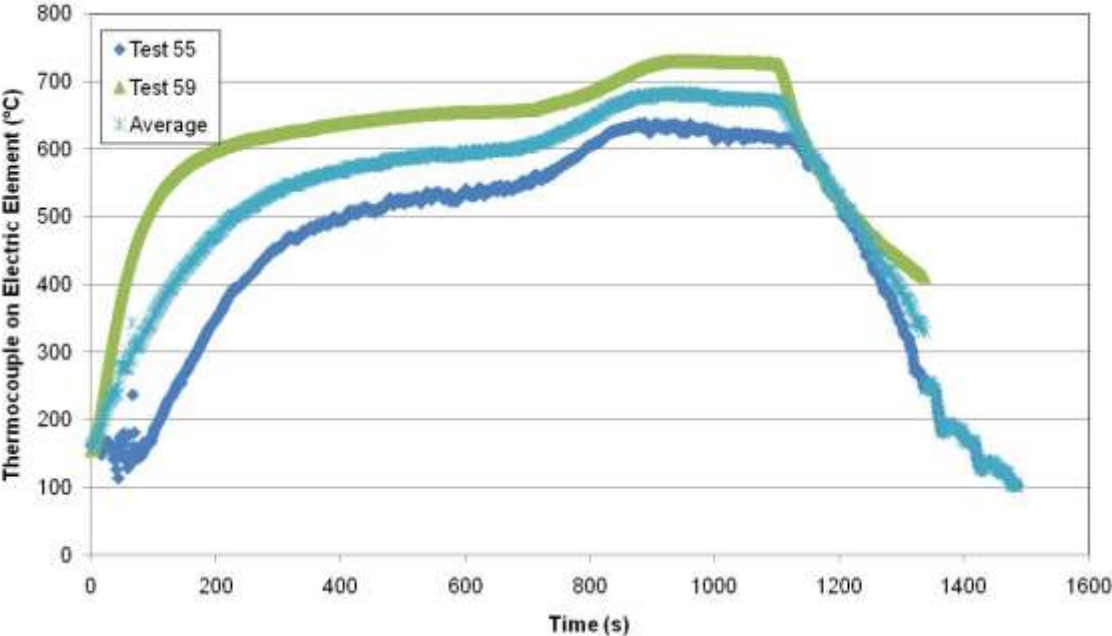
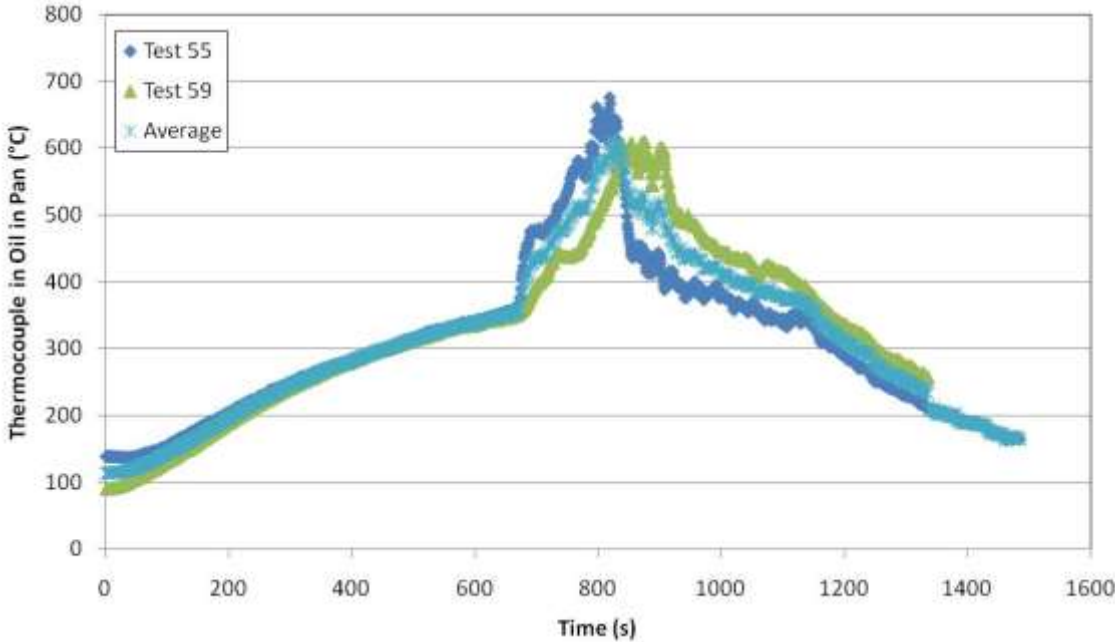
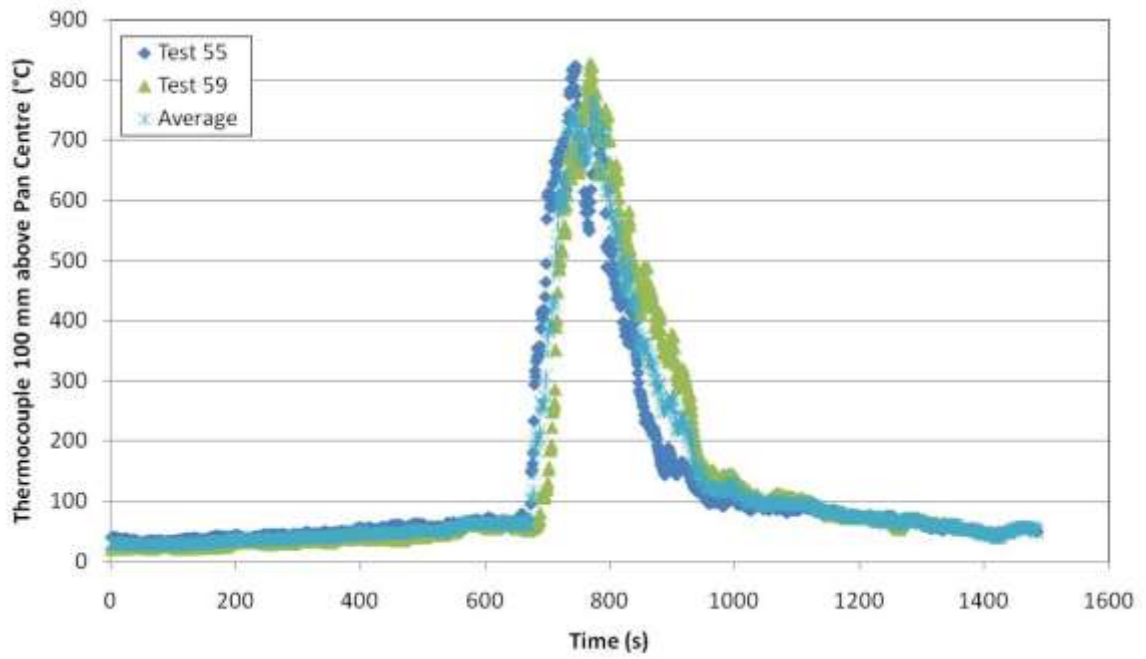

Figure 140: Thermocouple measurements for the thermocouple located on the heating element under the skillet for Tests 55 and 59 and the average of these tests.



(a)



(b)

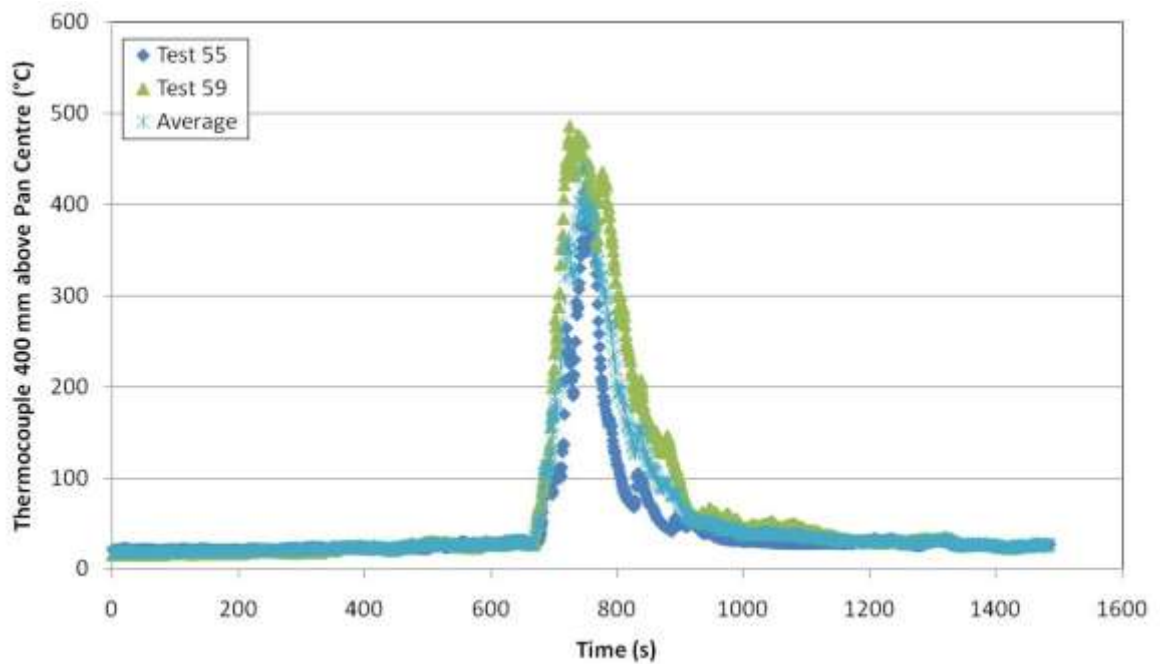

(c)

Figure 141: Thermocouple measurements for the thermocouple located (a) in the oil in the skillet, (b) 100 mm above the centre of the skillet, and (c) 400 mm above the centre of the skillet for Tests 55 and 59 and the average of these tests.

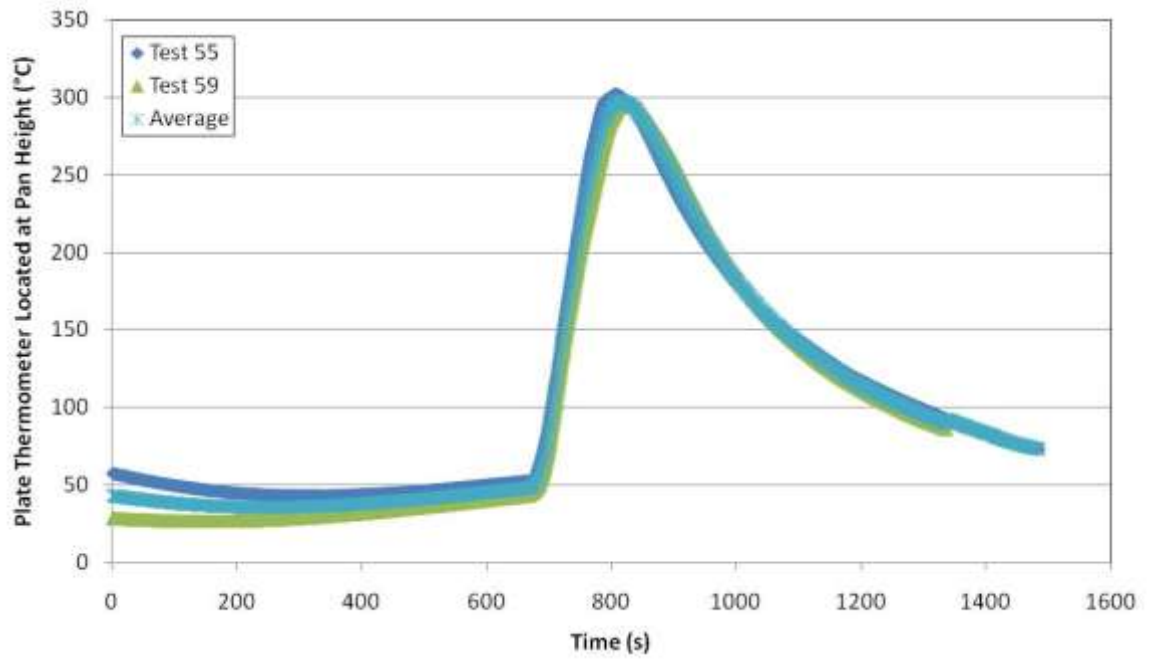

(a)

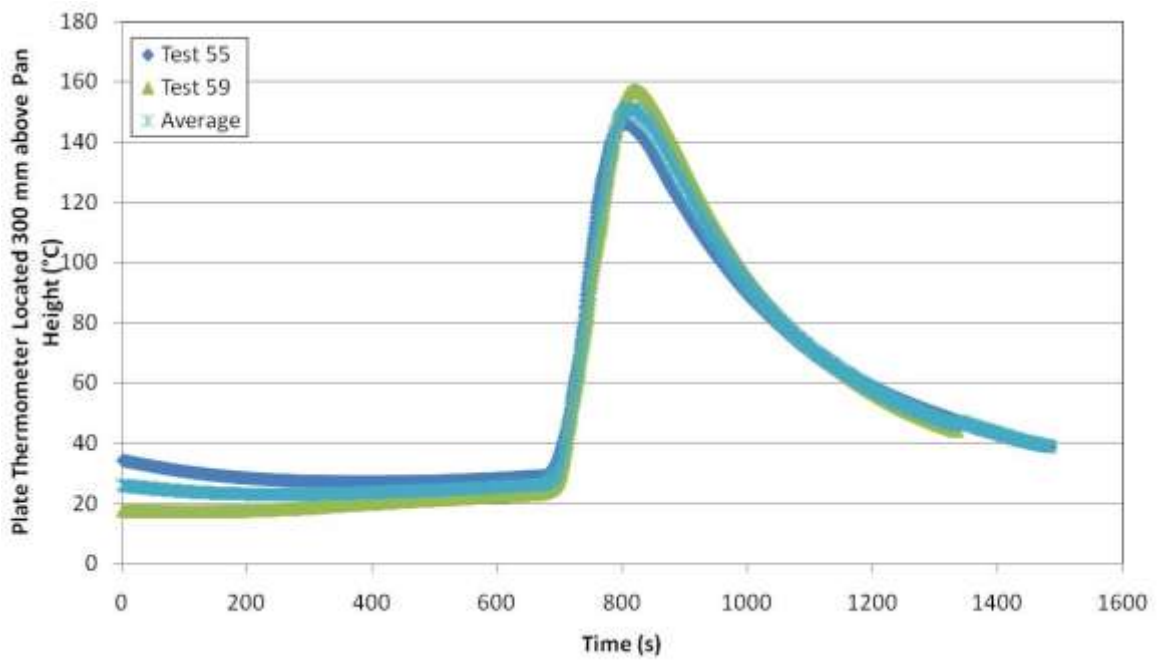

(b)

Figure 142: Plate thermometer temperature measurements for (a) at the height of the lip of the skillet, and (b) 300 mm above the lip of the skillet for Tests 55 and 59 and the average of these tests.

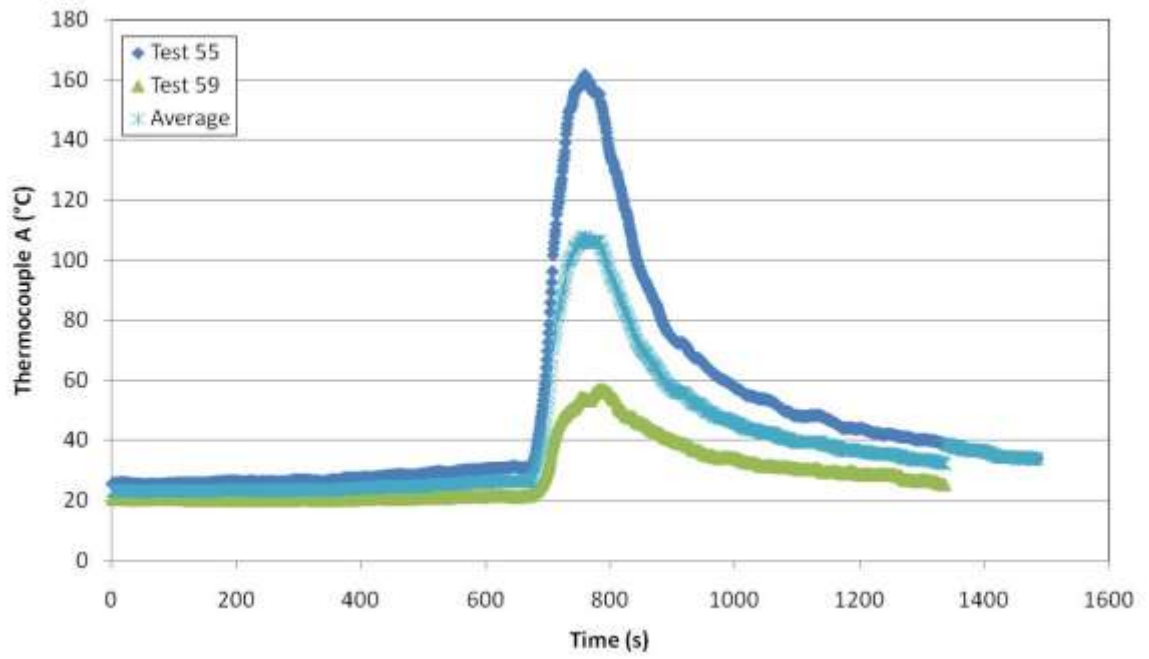

(a)

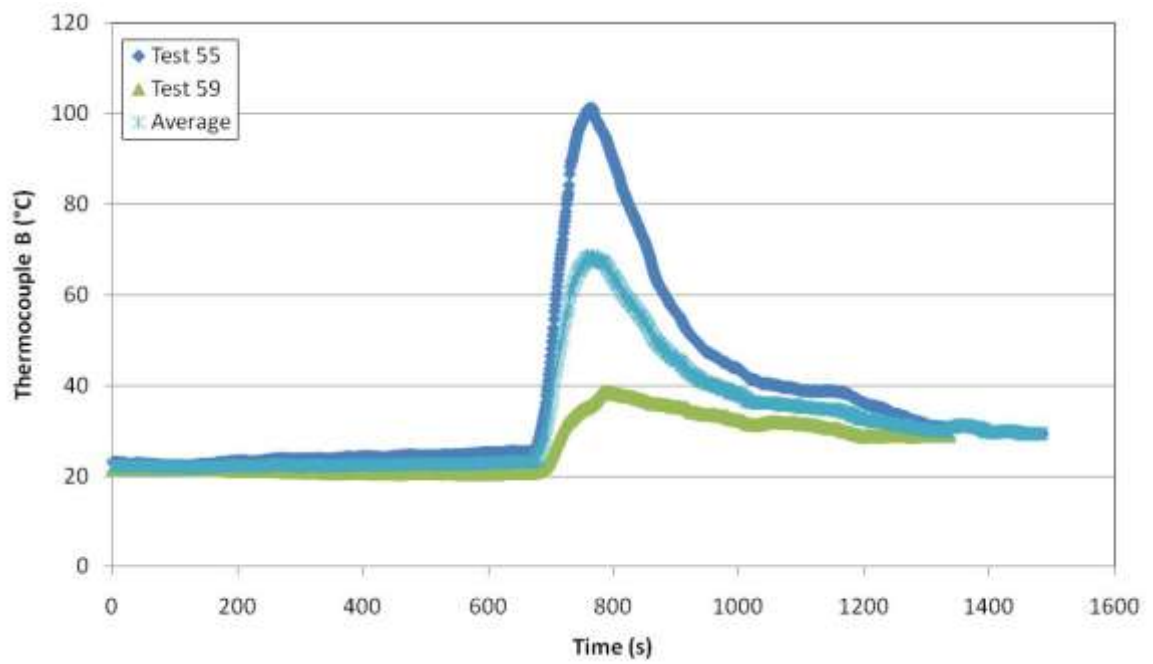

(b)

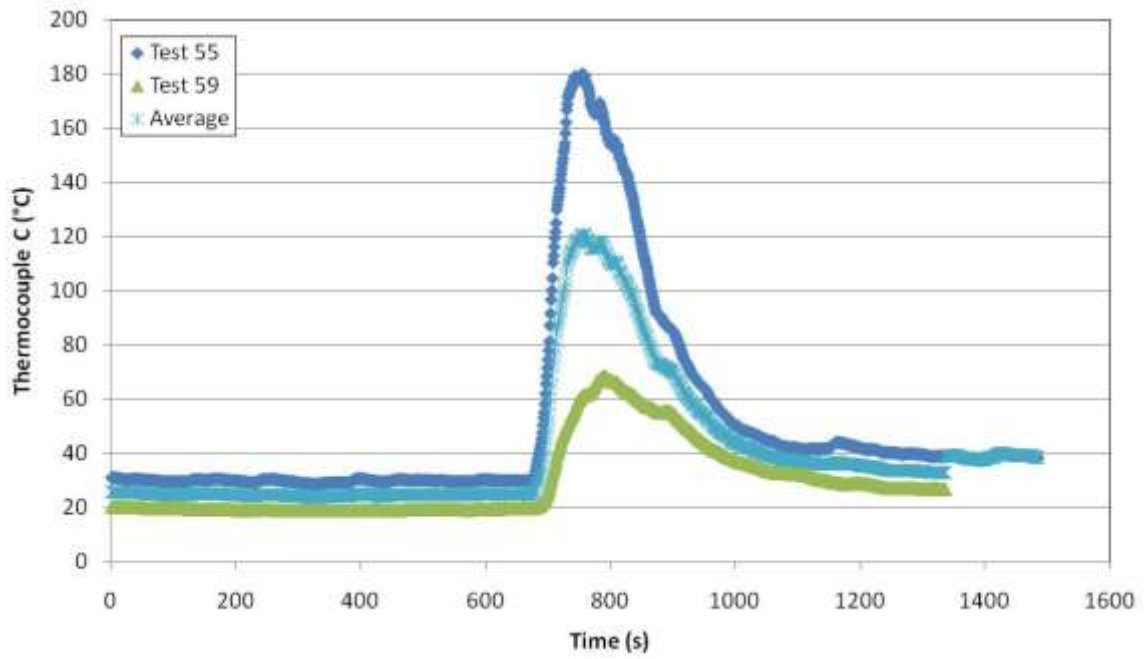

(c)

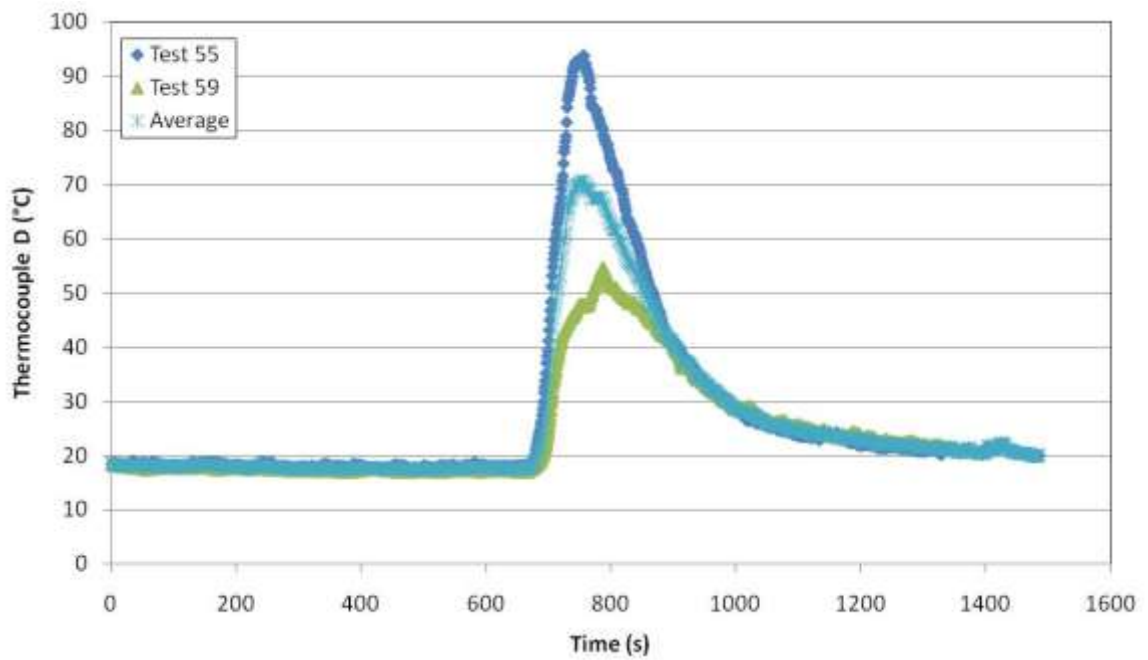

(d)

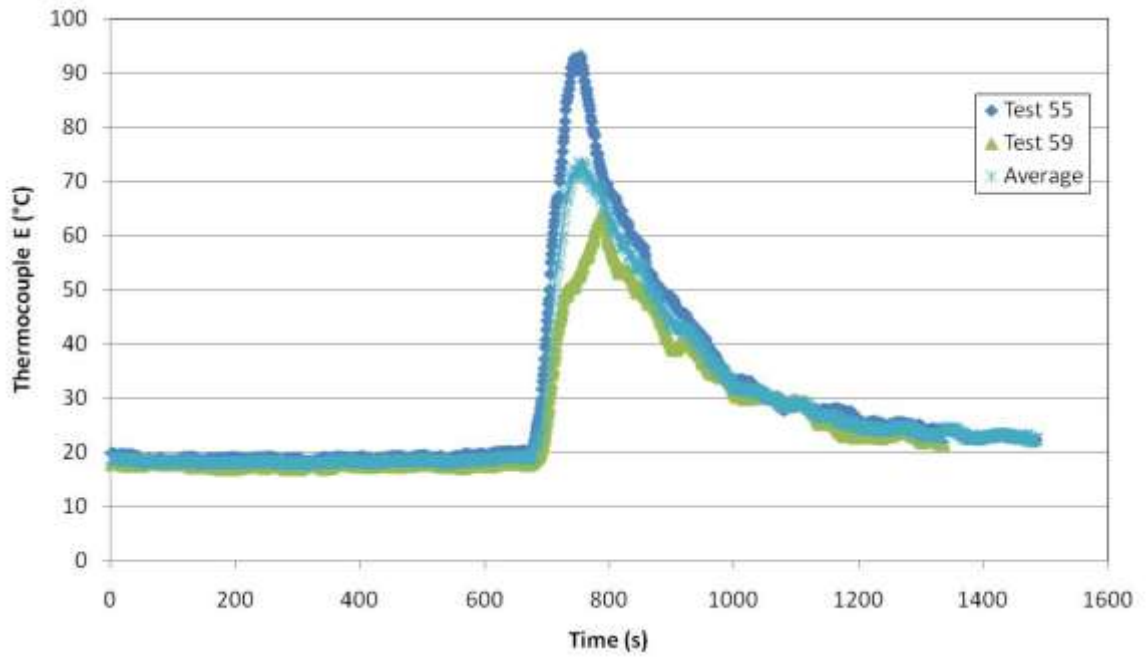

(e)

Figure 143: Thermocouple measurements of (a) thermocouple A, (b) thermocouple B, (c) thermocouple C, (d) thermocouple D, and (e) thermocouple E for Tests 55 and 59 and the average of these tests.

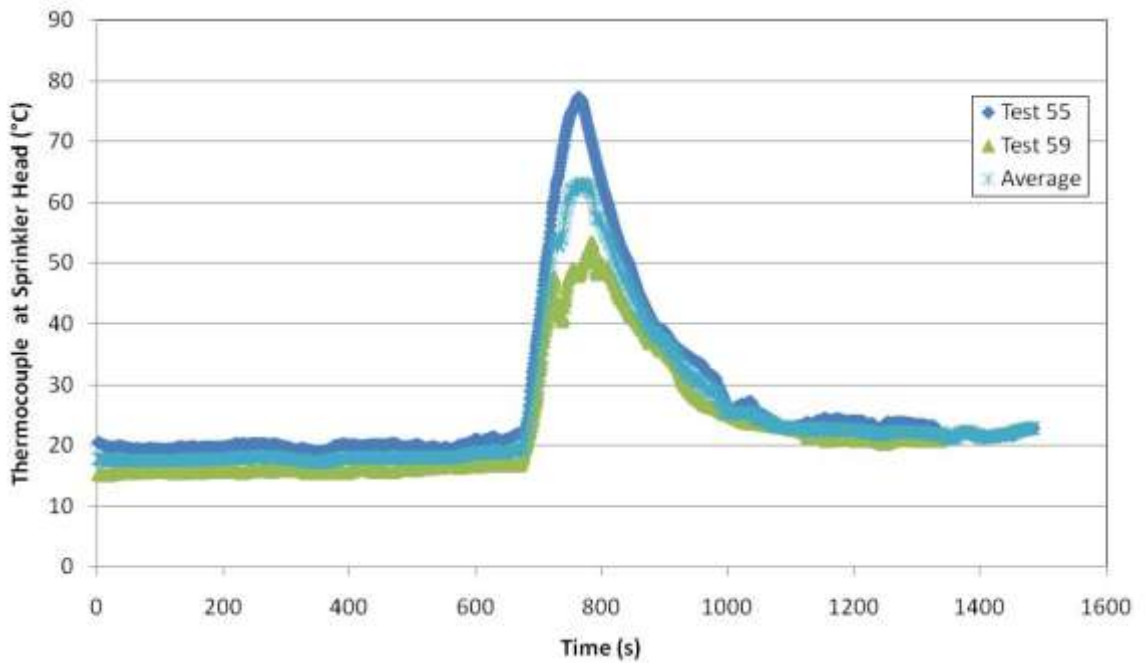

(a)

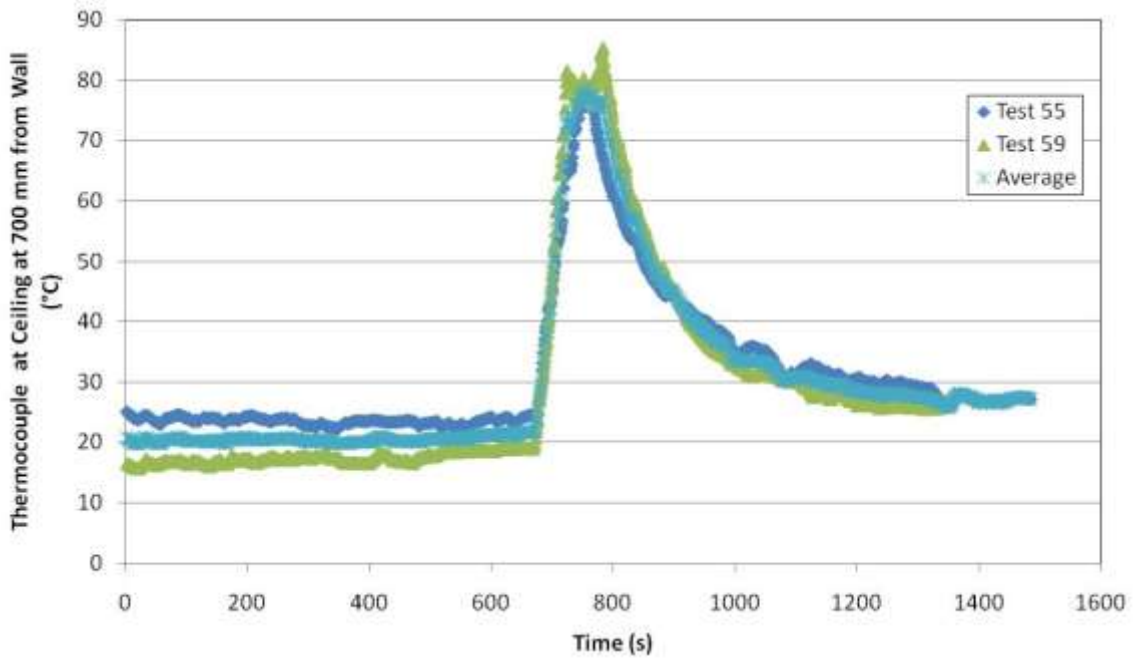

(b)

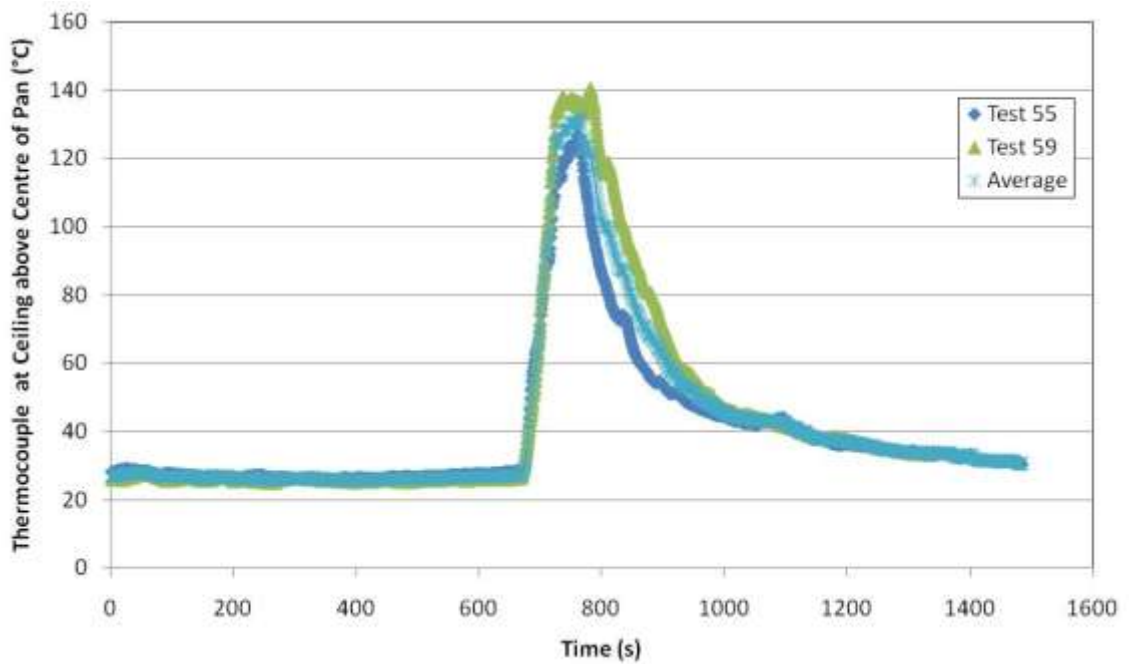

(c)

Figure 144: Thermocouple measurements at the ceiling (a) over the centre of the heating element, (b) 770 mm from the wall and centred in the corridor, and (c) directly above the centre of the skillet for Tests 55 and 59 and the average of these tests.

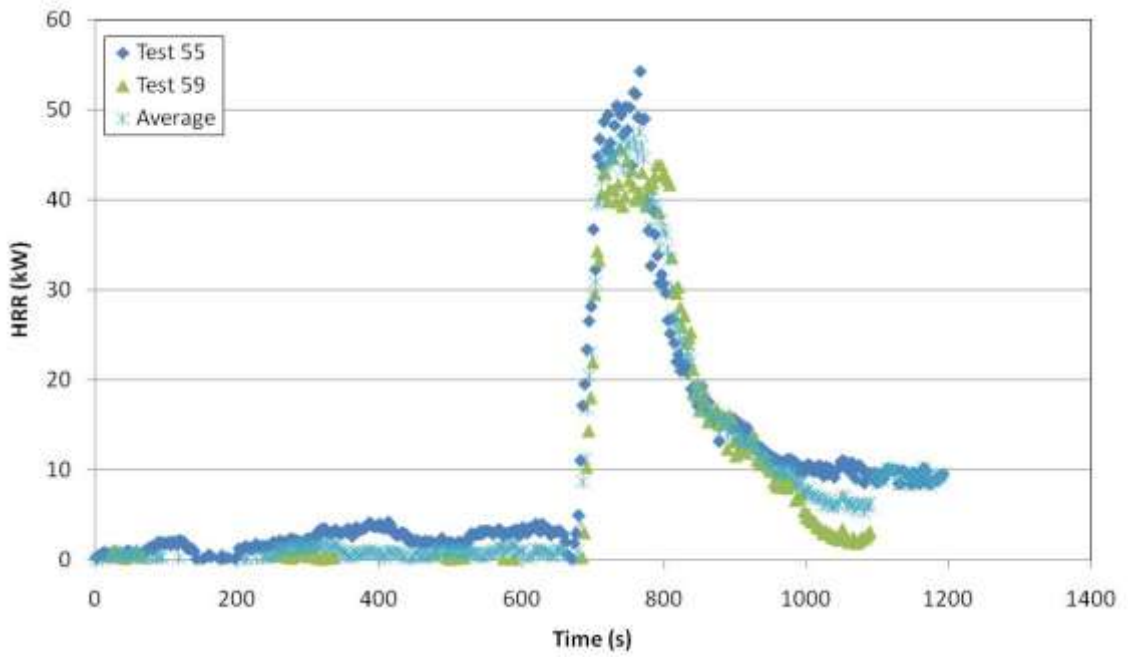
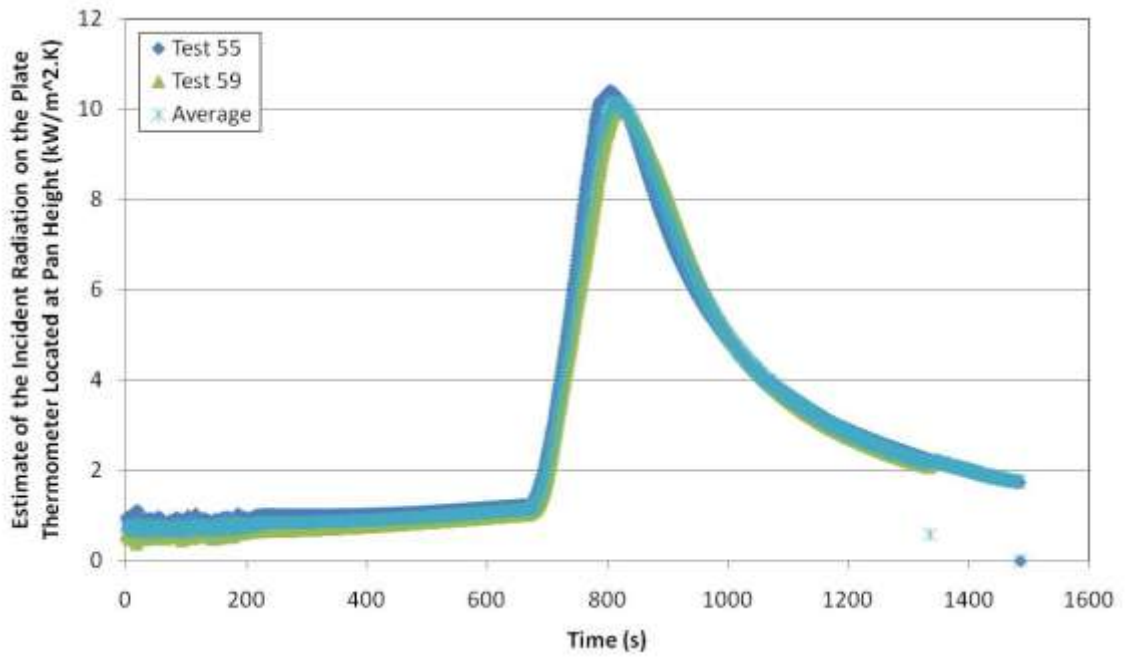
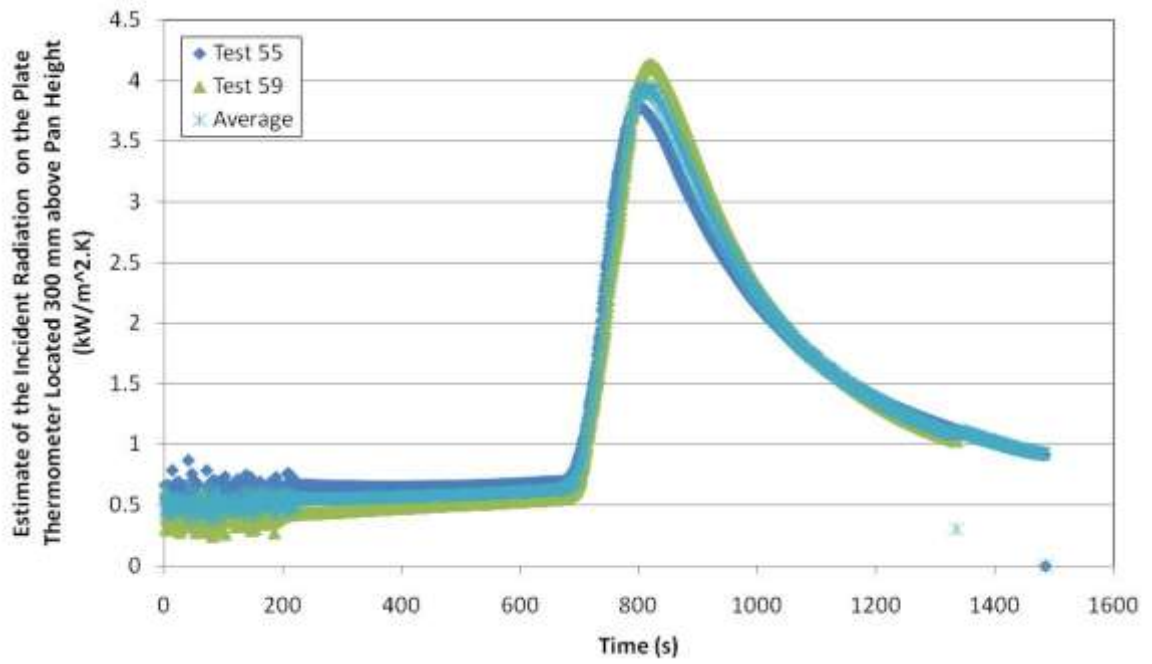

Figure 145: Heat release rates estimated from oxygen calorimetry for Tests 55 and 59 and the average of these tests.



(a)



(b)

Figure 146: Estimates of the incident radiation on the plate thermometer (a) at the height of the lip of the skillet, and (b) 300 mm above the lip of the skillet for Tests 55 and 59 and the average of these tests.

E.2 Normalised Average Test Results for the Free-Burning Challenge Scenario

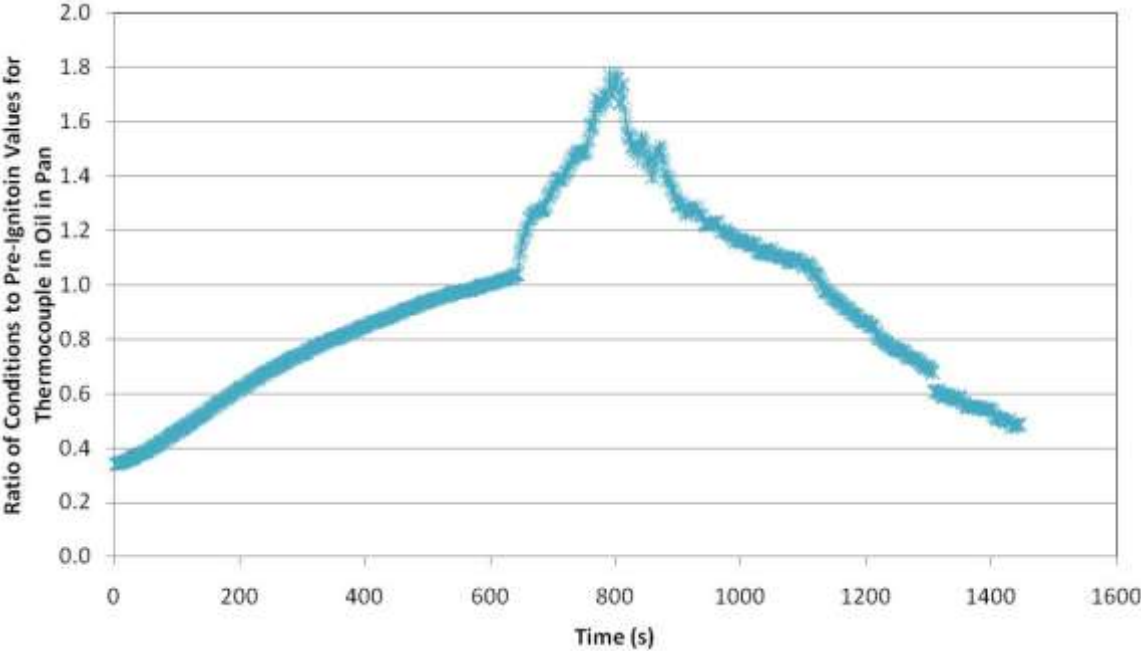

(a)

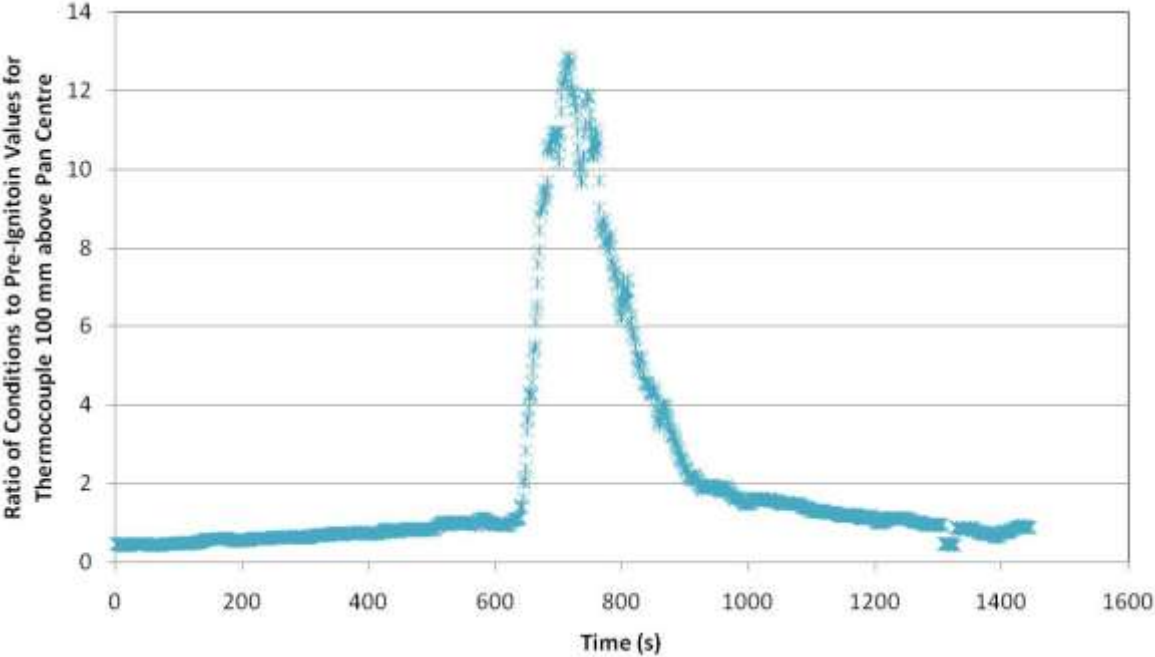

(b)

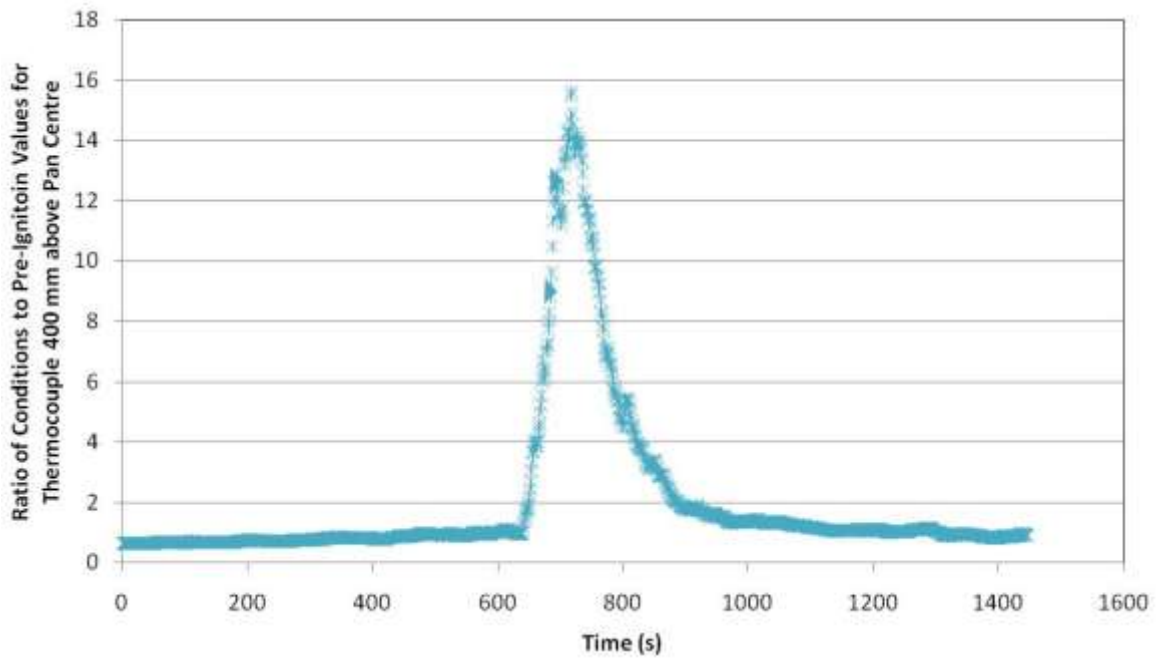

(c)

Figure 147: Normalised average thermocouple measurements for the thermocouple located (a) in the oil in the skillet, (b) 100 mm above the centre of the skillet, and (c) 400 mm above the centre of the skillet for Tests 55 and 59.

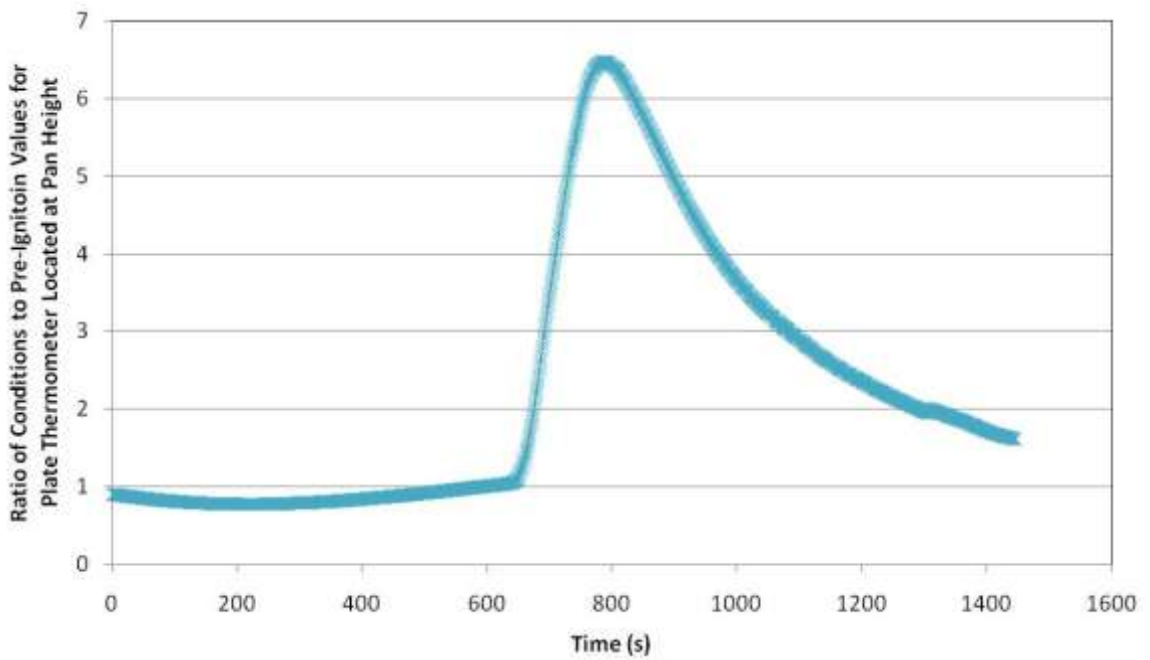

(a)

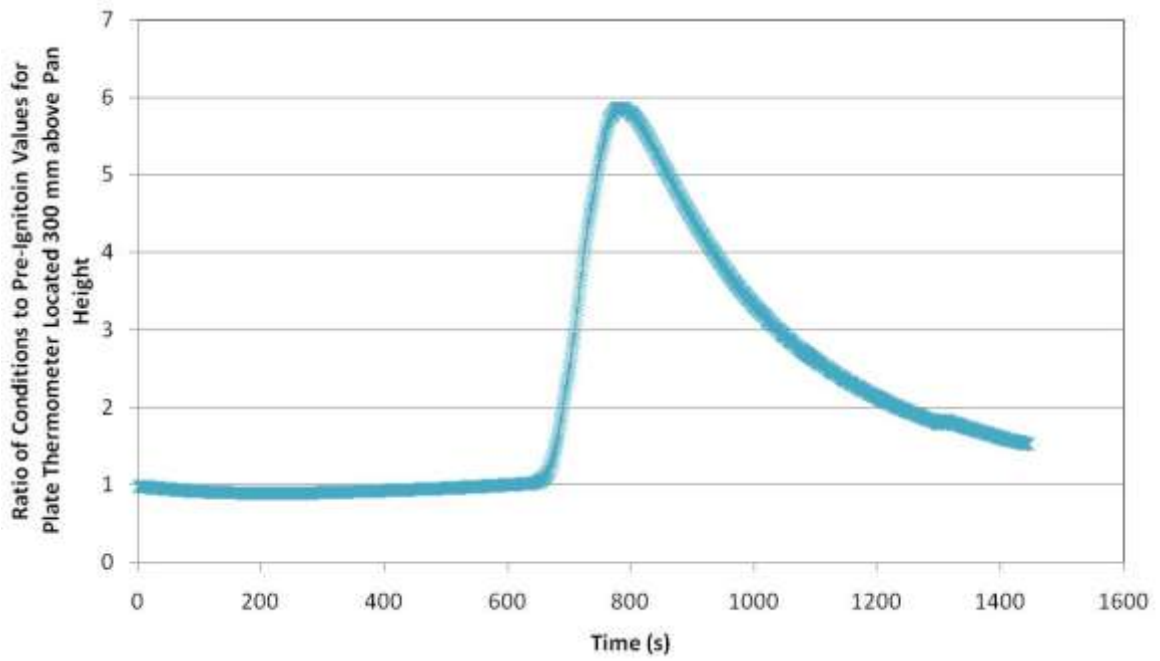

(b)

Figure 148: Normalised average plate thermometer temperature measurements for (a) at the height of the lip of the skillet, and (b) 300 mm above the lip of the skillet for Tests 55 and 59.

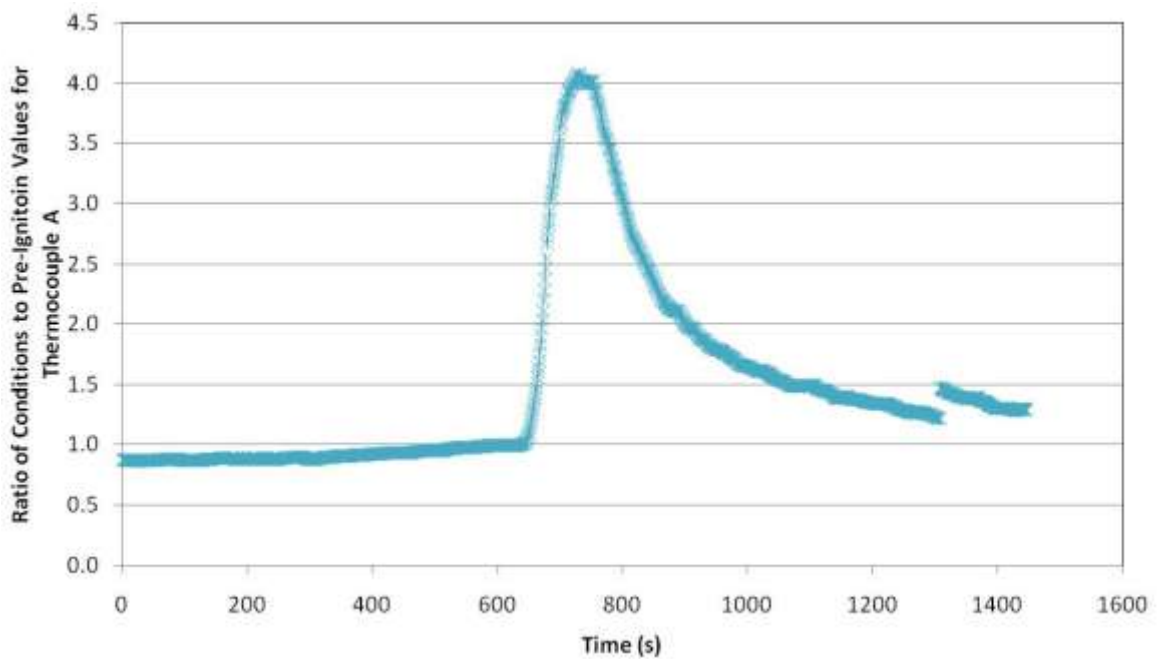

(a)

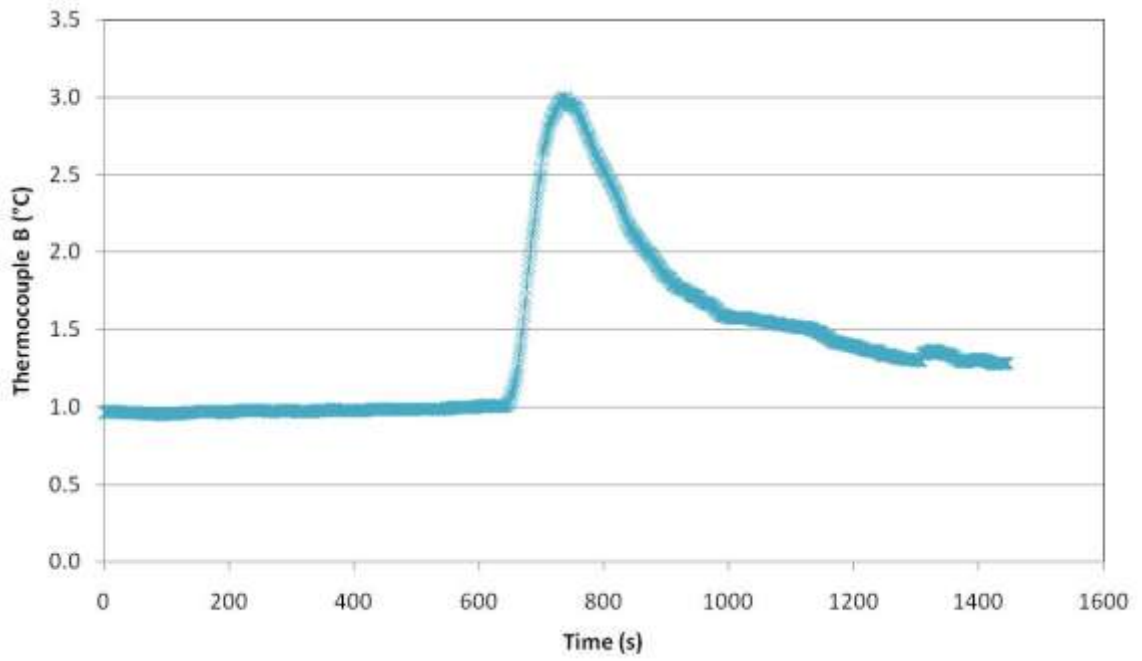

(b)

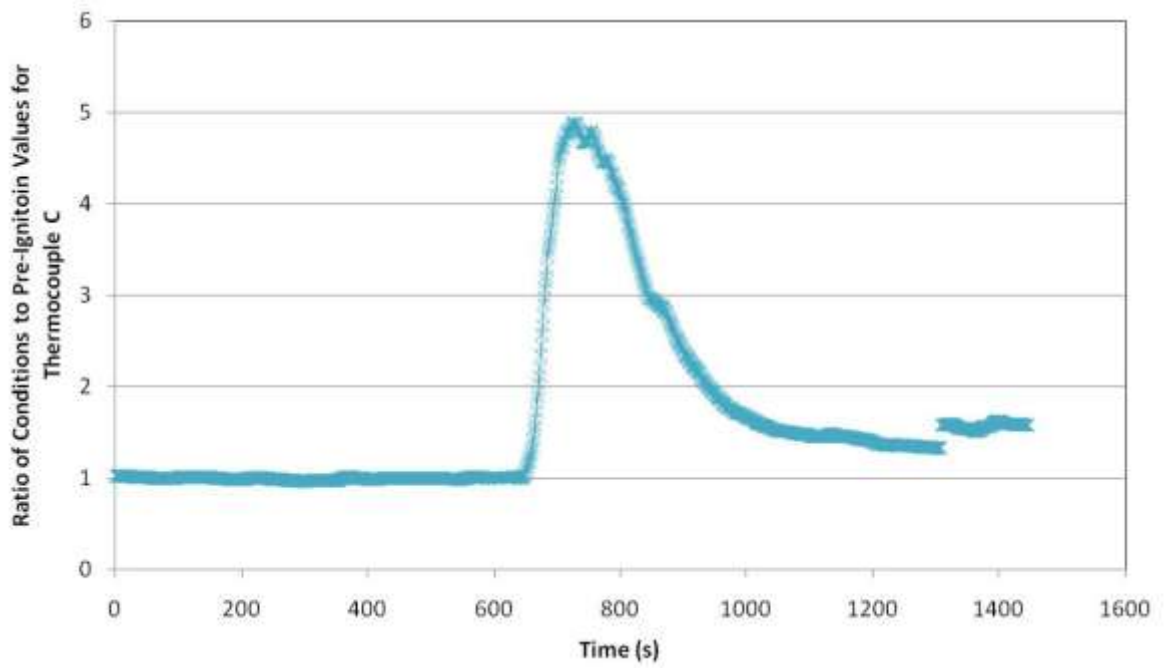

(c)

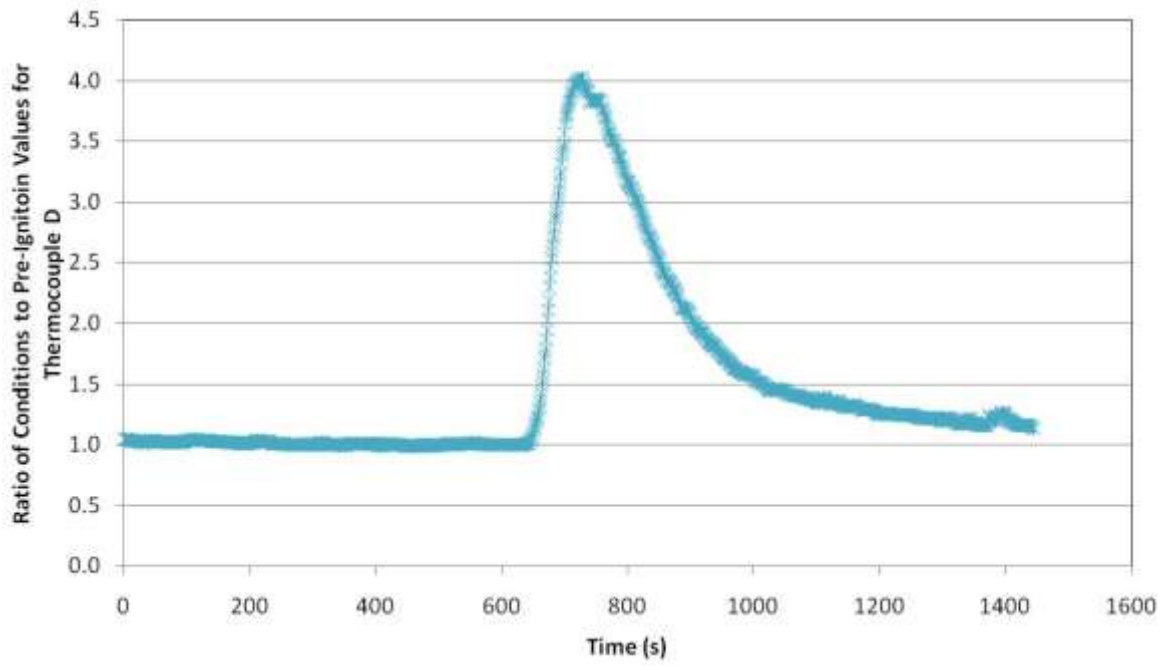

(d)

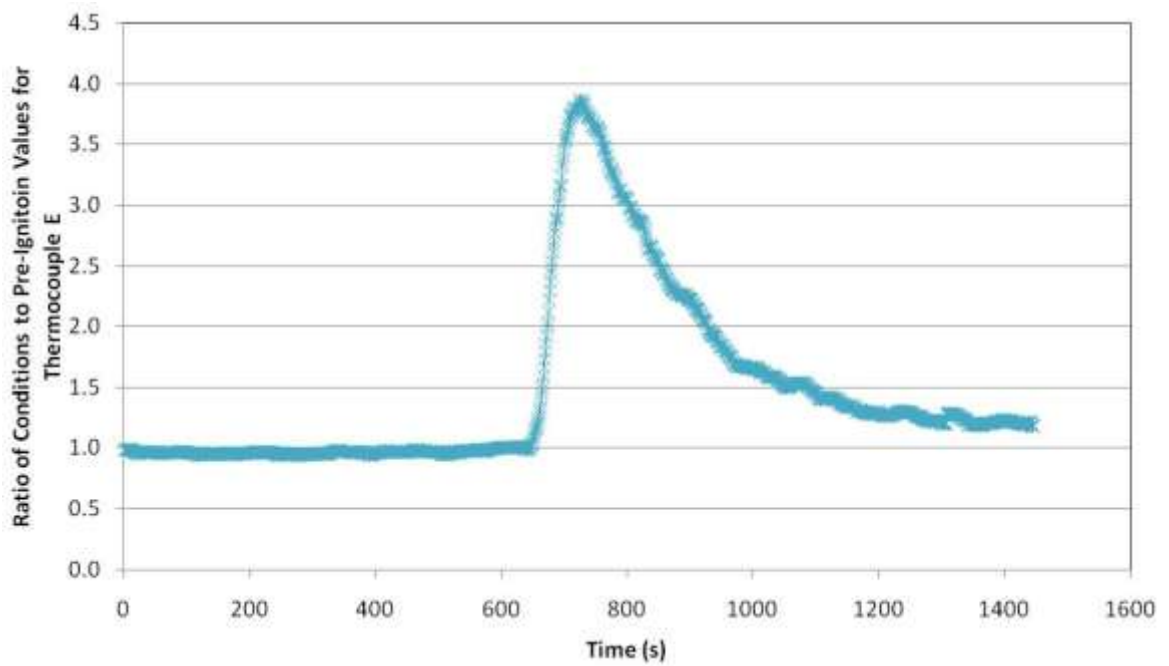

(e)

Figure 149: Normalised average thermocouple measurements of (a) thermocouple A, (b) thermocouple B, (c) thermocouple C, (d) thermocouple D, and (e) thermocouple E for Tests 55 and 59.

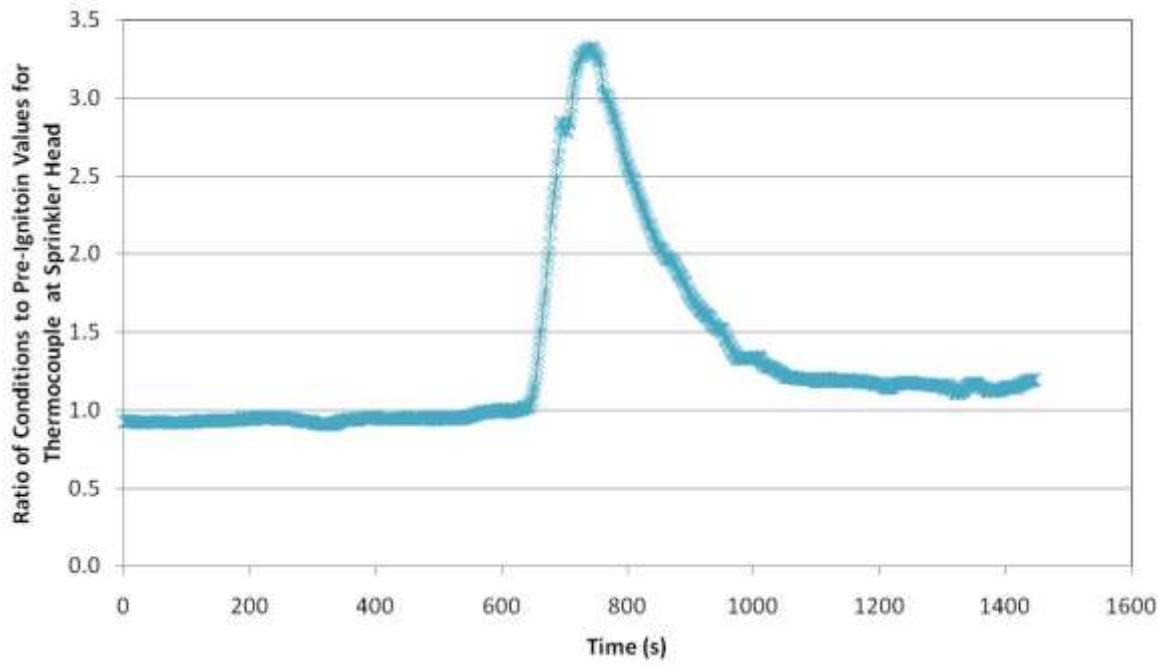

(a)

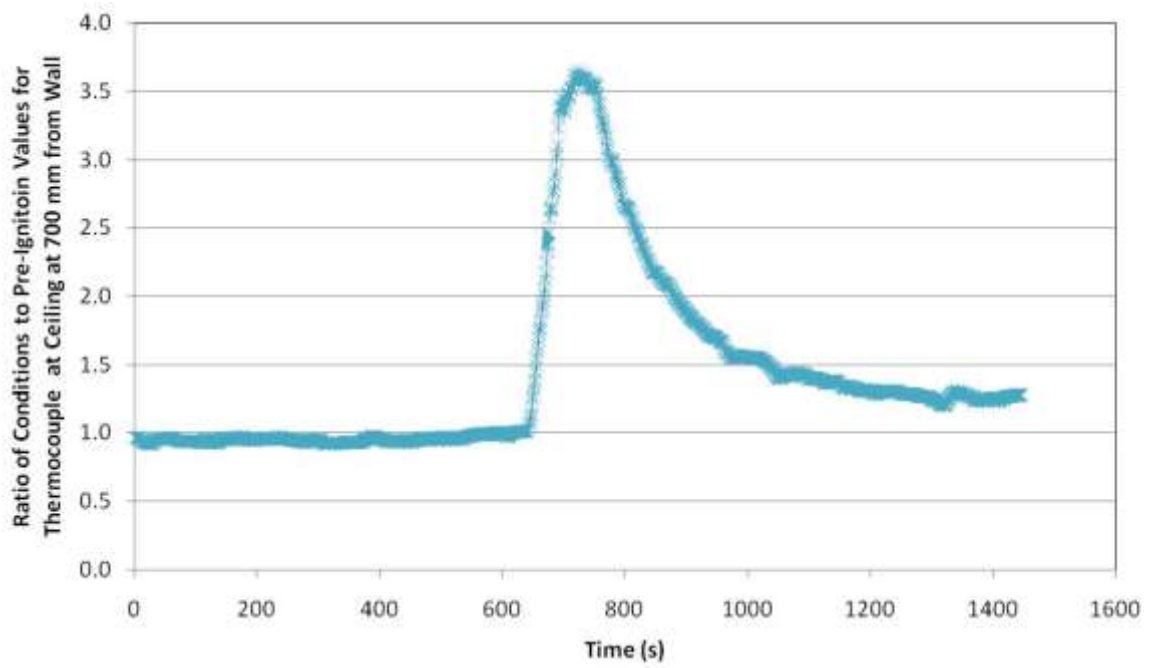

(b)

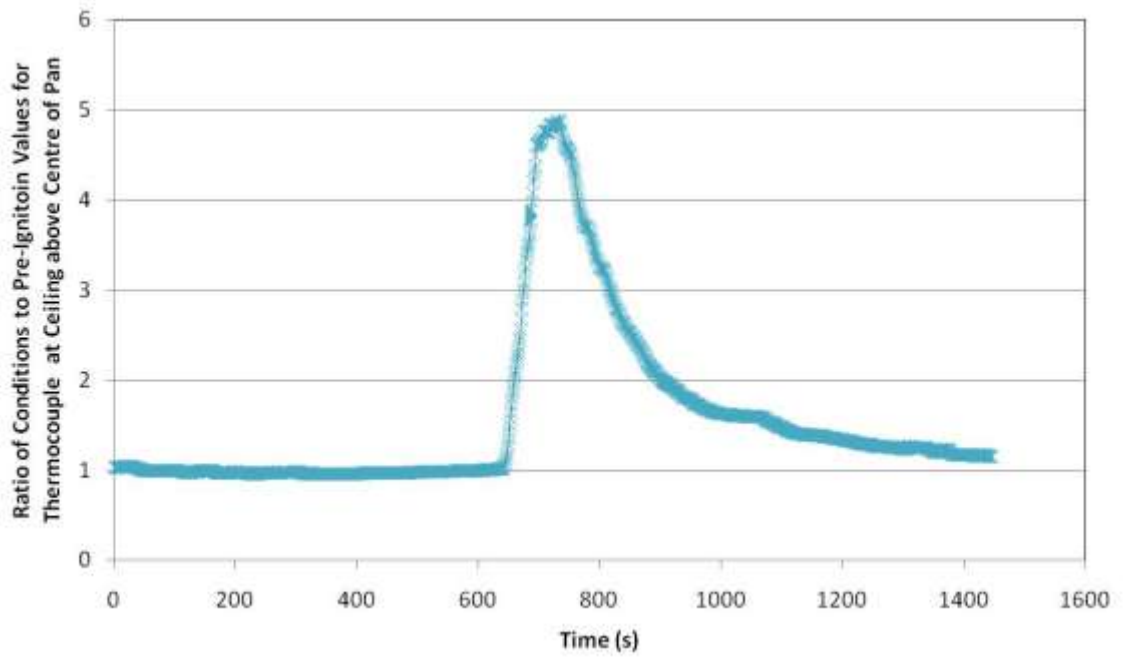

(c)

Figure 150: Normalised average thermocouple measurements at the ceiling (a) over the centre of the heating element, (b) 770 mm from the wall and centred in the corridor, and (c) directly above the centre of the skillet for Tests 55 and 59.